



NONRESIDENT TRAINING COURSE



July 1996

Signalman 3 & 2

NAVEDTRA 14244

NOTICE

Pages 5-2, 5-3, 7-10, 8-16, 9-13, 9-14, 9-16, 9-17, 9-18, 9-23, 9-24, 9-25, 9-26, 9-27, 9-28, 9-29, 9-30, 10-5, 10-7, 10-8, 10-19, 10-20, 10-22, 12-11, 12-12, 12-14, and 12-15, must be printed on a **COLOR** printer.

Although the words “he,” “him,” and “his” are used sparingly in this course to enhance communication, they are not intended to be gender driven or to affront or discriminate against anyone.

DISTRIBUTION STATEMENT A: Approved for public release; distribution is unlimited.

COMMANDING OFFICER
NETPDTC
6490 SAUFLEY FIELD ROAD
PENSACOLA FL 32509-5237

2 NOV 98

ERRATA #2

Specific Instructions and Errata for
Training Manual

SIGNALMAN

1. No attempt has been made to issue corrections for errors in typing, punctuation, etc.

2. Textbook. SIGNALMAN

Make the following changes:

- a. Page 3-2, last paragraph in left column, CHANGE "abbreviated codress" to "abbreviated plaindress."
- b. Page 3-2, Figure 3-1, right column, ADD "FM... Originator's Sign."
- c. Page 6-7, left column, transmission example, in Station A Transmits, CHANGE "AR" to "KFLN AR" in 3rd line. In Station B Transmits, Delete 2nd KFLN in 2nd line.
- d. Page 6-10, left column, commonly used signals, ADD "Z *I require a tug."
- e. Page 8-3, left column, paragraph 5, DELETE last sentence, "You will learn more about how to solve maneuvering board problems in Signalman, volumn II."
- f. Page 12-14, Figure 12-9, last row of flags, 2nd pair, CHANGE the white flag to a blue flag with two vertical strips.
- g. Page 13-22, right column, Sequence of Uprights, CHANGE "H" to "G" for gantry.
- h. Throughout SIGNALMAN, NAVEDTRA 12104-A, CHANGE:
 - "ACP 129" or "ACP 168", to "ACP 130"
(books were combined)
 - "NWP 4" to "NWP 6-01"
 - "NWP 14" to "NWP 4-01.4"
 - "NWP 22-3" to "NWP 3-02.1"

COMMANDING OFFICER
NETPDTC
6490 SAUFLEY FIELD ROAD
PENSACOLA FL 32509-5237

2 NOV 98

ERRATA #3

Specific Instructions and Errata for
Nonresident Training Course

SIGNALMAN 3 & 2

1. No attempt has been made to issue corrections for errors in typing, punctuation, etc.
2. To receive credit for deleted questions, show this errata to your local course administrator (ESO/scorer). The local course administrator is directed to correct the course and the answer key by indicating the question(s) deleted.

3. Assignment book

Make the following changes:

- a. Page 3, above question 1-26, after "TO" ADD "PROCEDURES FOR MAKING PUB CORRECTIONS."
- b. Page 6, question 1-59, in the question stem, after "... what," ADD "should you do to correct the problem?"
- c. Page 27, question 4-71, in the question stem, after "which of the," ADD "following is correct?"
- d. Page 37, question 6-25, column A. PROSIGN, DELETE the overscore to AA.
- e. Page 39, question 6-45, in alternative 2, DELETE "reception" and ADD "see if addressees have hoisted the correct signal."
- f. Page 42, question 7-2, in alternative 2, DELETE "A" on 43354A.

ERRATA #3
Page 2

- g. Page 60, question 9-52, in alternative 3, CHANGE "OTC" to "SOPA."
- h. Page 61, question 9-60, in the question stem between "What" and "problem" ADD "should you do to correct this?"
- i. Page 63, question 10-1, in the question stem, CHANGE "OTC" to "OCE."
- j. Page 65, above question 10-22, CHANGE "10-43" to "10-25."
- k. Page 67, question 10-51, column B. COMMODITY, CHANGE alternative 4 "Water" to "Feedwater."
- l. Page 82, above question 12-69, DELETE the "IN ANSWERING QUESTIONS 12-69 and 12-70. . ." statement.
- m. Page 85, question 13-29, alternative 3, CHANGE "NWP 22-3" to "NWP 3-02.1."
- n. CHANGE "ACP 129" to "ACP 130" in the following items:
 - o. 1-21 p. 1-23 q. 2-47 r. 3-12
 - s. 4-68 t. 5-65 u. 6-2 v. 6-32
 - w. 6-33 x. 6-38 y. 8-6 z. 9-66

NOTE: "ACP 129" and "ACP 168" have been combined and are now published as "ACP 130."

4. Delete the following questions:

3-29	3-56	4-14	4-48
5-39	5-56	6-1	6-37
9-34	9-57	9-58	9-64
12-33			

PREFACE

By enrolling in this self-study course, you have demonstrated a desire to improve yourself and the Navy. Remember, however, this self-study course is only one part of the total Navy training program. Practical experience, schools, selected reading, and your desire to succeed are also necessary to successfully round out a fully meaningful training program.

COURSE OVERVIEW: In completing this nonresident training course, you will demonstrate a knowledge of the subject matter by correctly answering questions on the following subjects: visual communications; signal equipment; messages, allied communications procedures; allied flaghoist procedures; international signaling; convoy communications; watchstanding duties; honors and ceremonies; security; amphibious duties; aircraft and ship identification.

THE COURSE: This self-study course is organized into subject matter areas, each containing learning objectives to help you determine what you should learn along with text and illustrations to help you understand the information. The subject matter reflects day-to-day requirements and experiences of personnel in the rating or skill area. It also reflects guidance provided by Enlisted Community Managers (ECMs) and other senior personnel, technical references, instructions, etc., and either the occupational or naval standards, which are listed in the *Manual of Navy Enlisted Manpower Personnel Classifications and Occupational Standards*, NAVPERS 18068.

THE QUESTIONS: The questions that appear in this course are designed to help you understand the material in the text.

VALUE: In completing this course, you will improve your military and professional knowledge. Importantly, it can also help you study for the Navy-wide advancement in rate examination. If you are studying and discover a reference in the text to another publication for further information, look it up.

*1996 Edition Prepared by
SMC(SW) Robert L. Kimmey
Reviewed by
SMC(SW) Andrew L. Cmehil*

Published by
NAVAL EDUCATION AND TRAINING
PROFESSIONAL DEVELOPMENT
AND TECHNOLOGY CENTER

**NAVSUP Logistics Tracking Number
0504-LP-026-8800**

Sailor's Creed

“I am a United States Sailor.

I will support and defend the Constitution of the United States of America and I will obey the orders of those appointed over me.

I represent the fighting spirit of the Navy and those who have gone before me to defend freedom and democracy around the world.

I proudly serve my country's Navy combat team with honor, courage and commitment.

I am committed to excellence and the fair treatment of all.”

CONTENTS

CHAPTER	PAGE
1. Introduction to Visual Communications	1-1
2. Signal Equipment	2-1
3. Messages	3-1
4. Allied Communications Procedures	4-1
5. Allied Flaghoist Procedures	5-1
6. International Signaling	6-1
7. Convoy Communications	7-1
8. Watchstanding Duties	8-1
9. Navigational Duties	9-1
10. Honors and Ceremonies	10-1
11. Security	11-1
12. Amphibious Duties	12-1
13. Aircraft and Ship Identification	13-1
14. Technical Administration	14-1
APPENDIX	
I. Glossary	AI-1
II. Flashing Light and Semaphore Drills	AII-1
III. References Used to Develop the TRAMAN	AIII-1
INDEX	INDEX-1

INSTRUCTIONS FOR TAKING THE COURSE

ASSIGNMENTS

The text pages that you are to study are listed at the beginning of each assignment. Study these pages carefully before attempting to answer the questions. Pay close attention to tables and illustrations and read the learning objectives. The learning objectives state what you should be able to do after studying the material. Answering the questions correctly helps you accomplish the objectives.

SELECTING YOUR ANSWERS

Read each question carefully, then select the BEST answer. You may refer freely to the text. The answers must be the result of your own work and decisions. You are prohibited from referring to or copying the answers of others and from giving answers to anyone else taking the course.

SUBMITTING YOUR ASSIGNMENTS

To have your assignments graded, you must be enrolled in the course with the Nonresident Training Course Administration Branch at the Naval Education and Training Professional Development and Technology Center (NETPDTC). Following enrollment, there are two ways of having your assignments graded: (1) use the Internet to submit your assignments as you complete them, or (2) send all the assignments at one time by mail to NETPDTC.

Grading on the Internet: Advantages to Internet grading are:

- you may submit your answers as soon as you complete an assignment, and
- you get your results faster; usually by the next working day (approximately 24 hours).

In addition to receiving grade results for each assignment, you will receive course completion confirmation once you have completed all the

assignments. To submit your assignment answers via the Internet, go to:

<http://courses.cnet.navy.mil>

Grading by Mail: When you submit answer sheets by mail, send all of your assignments at one time. Do NOT submit individual answer sheets for grading. Mail all of your assignments in an envelope, which you either provide yourself or obtain from your nearest Educational Services Officer (ESO). Submit answer sheets to:

COMMANDING OFFICER
NETPDTC N331
6490 SAUFLEY FIELD ROAD
PENSACOLA FL 32559-5000

Answer Sheets: All courses include one “scannable” answer sheet for each assignment. These answer sheets are preprinted with your SSN, name, assignment number, and course number. Explanations for completing the answer sheets are on the answer sheet.

Do not use answer sheet reproductions: Use only the original answer sheets that we provide—reproductions will not work with our scanning equipment and cannot be processed.

Follow the instructions for marking your answers on the answer sheet. Be sure that blocks 1, 2, and 3 are filled in correctly. This information is necessary for your course to be properly processed and for you to receive credit for your work.

COMPLETION TIME

Courses must be completed within 12 months from the date of enrollment. This includes time required to resubmit failed assignments.

PASS/FAIL ASSIGNMENT PROCEDURES

If your overall course score is 3.2 or higher, you will pass the course and will not be required to resubmit assignments. Once your assignments have been graded you will receive course completion confirmation.

If you receive less than a 3.2 on any assignment and your overall course score is below 3.2, you will be given the opportunity to resubmit failed assignments. **You may resubmit failed assignments only once.** Internet students will receive notification when they have failed an assignment--they may then resubmit failed assignments on the web site. Internet students may view and print results for failed assignments from the web site. Students who submit by mail will receive a failing result letter and a new answer sheet for resubmission of each failed assignment.

COMPLETION CONFIRMATION

After successfully completing this course, you will receive a letter of completion.

ERRATA

Errata are used to correct minor errors or delete obsolete information in a course. Errata may also be used to provide instructions to the student. If a course has an errata, it will be included as the first page(s) after the front cover. Errata for all courses can be accessed and viewed/downloaded at:

<http://www.advancement.cnet.navy.mil>

STUDENT FEEDBACK QUESTIONS

We value your suggestions, questions, and criticisms on our courses. If you would like to communicate with us regarding this course, we encourage you, if possible, to use e-mail. If you write or fax, please use a copy of the Student Comment form that follows this page.

For subject matter questions:

E-mail: n314.products@cnet.navy.mil
Phone: Comm: (850) 452-1001, Ext. 1826
DSN: 922-1001, Ext. 1826
FAX: (850) 452-1370
(Do not fax answer sheets.)
Address: COMMANDING OFFICER
NETPDTC N314
6490 SAUFLEY FIELD ROAD
PENSACOLA FL 32509-5237

For enrollment, shipping, grading, or completion letter questions

E-mail: fleetservices@cnet.navy.mil
Phone: Toll Free: 877-264-8583
Comm: (850) 452-1511/1181/1859
DSN: 922-1511/1181/1859
FAX: (850) 452-1370
(Do not fax answer sheets.)
Address: COMMANDING OFFICER
NETPDTC N331
6490 SAUFLEY FIELD ROAD
PENSACOLA FL 32559-5000

NAVAL RESERVE RETIREMENT CREDIT

If you are a member of the Naval Reserve, you may earn retirement points for successfully completing this course, if authorized under current directives governing retirement of Naval Reserve personnel. For Naval Reserve retirement, this course is evaluated at 21 points. Those points will be credited as follows: 12 points for the satisfactory completion of assignments 1 through 8, and 9 points for the satisfactory completion of assignments 9 through 13. (Refer to *Administrative Procedures for Naval Reservists on Inactive Duty*, BUPERSINST 1001.39, for more information about retirement points.)

Student Comments

Course Title: Signalman 3 & 2

NAVEDTRA: 14244 **Date:** _____

We need some information about you:

Rate/Rank and Name: _____ SSN: _____ Command/Unit _____

Street Address: _____ City: _____ State/FPO: _____ Zip _____

Your comments, suggestions, etc.:

<p>Privacy Act Statement: Under authority of Title 5, USC 301, information regarding your military status is requested in processing your comments and in preparing a reply. This information will not be divulged without written authorization to anyone other than those within DOD for official use in determining performance.</p>
--

NETPDTC 1550/41 (Rev 4-00)

CHAPTER 1

INTRODUCTION TO VISUAL COMMUNICATION

Your choice to become a Signaller is a very good one. The Signaller rating is one of the oldest in the Navy, and visual communication—the first form of nautical communications—continues undiminished in importance today. You will find your job interesting, rewarding, and full of the satisfaction that comes of service to the Navy and the United States. At the level of operating forces, communications, as you will learn, is truly the voice of command in a visible way. The communication organization aboard ship is under the control of the commanding officer. In the transmission and reception of signals and messages, communicators actively participate in the exercise of command.

The fleet needs capable personnel in all ratings, because an effective naval force is only as good as the people who man the ships. Even with the most modern equipment, the force is seriously handicapped without competent personnel to operate and maintain that equipment. Good people are plentiful, but their capability depends on their training.

This manual contains the basic knowledge you need for advancement in the Signaller rating. Skills in personnel advancement requirements (PARs), including a performance test, also are required, but these can only be developed through practice and experience.

Personnel Qualification Standard (PQS) is a qualification for officers and enlisted personnel to perform certain duties. The Signaller PQS booklet, *Visual Communication*, NAVEDTRA 43354B, contains the fundamentals, systems, and watch stations recognized by CNET as the minimum qualification for Signaller supervisor aboard U.S. Navy ships. Included are expert lookout, flagbag operator, semaphore operator, searchlight operator, boat Signaller, amphibious Signaller, Signaller of the watch, in-port duty Signaller, recorder/messenger, signal bridge spotter, and AN/KAS-1 operator. This PQS will assist you in becoming a more productive member of the Signaller community.

As a part of the Navy's training program, *Signaller*, is designed to help you meet the occupational standards for advancement in the Signaller rating.

To become an expert is quite a challenge, and you will derive considerable satisfaction from mastering the art of signaling. Through your initiative, study, practice, and hard work, the time will come when your shipmates will look upon you as an expert.

THE SIGNALMAN RATING

LEARNING OBJECTIVES: State the purpose of a Signaller aboard ship. Identify five areas in which Signallers must be proficient.

All the planning, organizing, and training that go into the makeup of a signal gang are designed for one purpose—to perfect the Signaller's ability to transmit and receive messages vital to the operation of the ship. The Signaller mans the visual communication link with semaphore flags, flaghoist, and searchlights.

In addition to visual communications, a Signaller also must be proficient in navigation. Navigation duties include the reading, stowing, and correcting of charts; being able to help pilot a ship in restricted waters; and being familiar with the Rules of the Road, navigational aids, and using navigational equipment. (Navigational duties are discussed in chapter 9.) In addition, the Signaller must be skilled in voice radio operations and procedures; be able to properly render honors and ceremonies; be experienced in the principles of recognition and be quick to recognize personal flags and pennants of U.S. and foreign officers; be able to act as expert lookouts; and be able to demonstrate know how in many other related skills.

As a Signaller, you can expect to serve on a variety of ships—from the largest carrier to the smallest patrol craft—and at various shore commands. Aboard some ships, you may have to help with the navigation in addition to your visual signaling duties. On other ships you might practice only your visual signaling skills.

Now you know, in a general way, what is required of a Signaller. But you may ask, "What must I do to become a Signaller?" The demands are **A WILLINGNESS TO LEARN** and **A**

WILLINGNESS TO WORK. Together, these qualities can take you a long way in the Navy.

THE SIGNAL BRIDGE

LEARNING OBJECTIVES: Describe the various types of signal bridges and state one characteristic all have in common.

The signal bridge, where you will spend your working hours, is a platform high in the superstructure of a ship. All visual signaling takes place from this point. The size of the signal bridge and its location vary according to the type of ship. On some ships the bridge is on the same deck as the navigation bridge, where the conning officer is stationed. On others it is on the flag bridge or on a separate bridge.

A cruiser has a large bridge, providing ample space for the signal gang to operate. On the other hand, the bridge of a fast frigate cannot offer nearly as much signaling space. Some ships are equipped with divided signal bridges, port and starboard. Regardless of how the signal bridge is laid out, it always is designed to give the best possible vision from ship to horizon.

In many respects, flaghoist, semaphore, and flashing light are far superior to radio. Especially is this true when the mission of the unit or force demands radio silence; that is when security considerations silence all electronic communications. With radio silence in effect, only visual signals may be used to convey messages. Visual signaling is used widely, even in peacetime when security often is not a major issue. Flaghoist is used almost exclusively by task force commanders to maneuver their ships during daylight hours.

As a Signaller 3 or 2, you must have the ability to send and receive messages and recognition signals by flashing light, semaphore, and flaghoist. You must learn to prepare the headings for outgoing messages and to become proficient in the correct procedures for handling, routing, and filing messages.

GETTING ORIENTED

One of your first steps in becoming a Signaller is to learn all you can about the organization in which you will work. Obviously, no book can anticipate or cover all the questions you will have about your new job; so when questions arise, check with your division petty officer. Make it a point to learn something new each day about your job and your ship. On a modern

ship, ignorance is a very real danger to you and your shipmates.

Become familiar with all the different spaces of your ship and what their functions are. Put particular emphasis on the communication and navigation spaces, such as the communication center, radio central, the bridge, and the signal bridge. Learn the quickest, shortest, and alternate routes to each from different sections of the ship.

MILITARY APPEARANCE

Another thing to learn is that Signallers are generally considered the very smartest in military appearance. Therefore, always be in a clean, neat, and proper uniform. Also, the spaces in which you work should be the cleanest and most orderly aboard ship. It is your job to make it so.

DUTIES TO PERFORM

LEARNING OBJECTIVES: Define the term *phonetic alphabet*; list procedures to form letters of the alphabet and numerals; state the purpose of the message blank. Describe the following Signaller duties: flagbag operator, spotter, searchlight operator, semaphore operator, Signaller of the watch, boat Signaller, in-port duty Signaller, and Signaller supervisor.

As a Signaller, you will be tasked to perform many duties. How you perform these duties could directly affect the mission of your ship. Some of these duties are explained in the following paragraphs.

RECORDING MESSAGES

One of your first duties after joining the signal gang will be to record visual messages. Probably on your first day on the bridge you heard one of the operators call out, "Stand by to record." You may have noted that the operator went directly to the signal light and began to receive the message, while another Signaller, maybe a striker like yourself, grabbed a message blank and began to record the information the operator called out.

Phonetic Alphabet

Some of the words called out may not have made much sense to you—words like ALFA, YANKEE, and DELTA. To experienced communicators they mean the letters A, Y, and D. The Signaller was using the phonetic alphabet, a system set up in which each letter of the alphabet has a word equivalent. It is used widely in naval communications, to avoid mistaking letters that sound alike, such as B and C or M and N. You will have to know this alphabet before you can go any further in communications, so study the alphabet and the proper pronunciation, as shown in figure 1-1. It is not very difficult, and you should not have any trouble mastering it in a few days.

Lettering

The accuracy of communications, especially of coded messages, depends on exact adherence to procedures and on legibility of writing. For this reason it is necessary that all letters and numerals be distinctly and legibly made, not only so that you can read them but also so that they can be

easily read by anyone else. If you write a letter or numeral and it is mistaken for some similar letter or numeral, confusion will result. Often one mistake can change the entire meaning of a message. This can be disastrous when lives and ships are at stake.

Figures 1-2, 1-3, and 1-4 show how letters and figures should be formed and what sequence should be followed in making the various strokes.

To ensure uniformity, it is necessary that letters and numerals be printed and that you learn the following system of lettering:

1. A straight line is the foundation stroke. The letters E, H, and F have the center horizontal stroke slightly above the middle. The strokes of the letters X, Y, and K join slightly above the middle.

2. The letters O, Q, C, and G are made as circles. The letter B is slightly smaller at the top and has the center horizontal part slightly above the middle. The letters R and S are slightly smaller at the top.

LETTER	PHONETIC ALPHABET	PRONUNCIATION GUIDE	
A	ALFA	AL FAH	• —
B	BRAVO	BBRAH VOH	• • • •
C	CHARLIE	CHAR LEE/SHAR LEE	• • • •
D	DELTA	DEL TAH	• • • •
E	ECHO	ECK OH	• • • •
F	FOXTROT	FOKS TROT	• • • •
G	GOLF	GOLF	• • • •
H	HOTEL	HOH TELL	• • • •
I	INDIA	IN DEE AH	• • • •
J	JULIETT	JEW LEE ETT	• • • •
K	KILO	KEY LOH	• • • •
L	LIMA	LEE MAH	• • • •
M	MIKE	MIKE	• • • •
N	NOVEMBER	NO VEM BER	• • • •
O	OSCAR	OSS CAH	• • • •
P	PAPA	PAH PAH	• • • •
Q	QUEBEC	KEH BECK	• • • •
R	ROMEO	ROW ME OH	• • • •
S	SIERRA	SEE AIR PAH	• • • •
T	TANGO	TANG GO	• • • •
U	UNIFORM	YOU NEE FORM/QQ NEE FORM	• • • •
V	VICTOR	VIK TAH	• • • •
W	WHISKEY	WISS KEY	• • • •
X	XRAY	ECKS RAY	• • • •
Y	YANKEE	YANG KEY	• • • •
Z	ZULU	ZOO LOO	• • • •

NUMBER	PHONETIC ALPHABET	INTERNATIONAL MORSE CODE
1	WUN	• — — —
2	TOO	• • — —
3	TREE	• • • —
4	FOUR-ER	• • • •
5	FIFE	• • • •
6	SIX	• — • •
7	SEV-EN	• — • •
8	AIT	• — • •
9	NINE-ER	• — • •
0	ZE-RO	• — • •



Figure 1-2.—Straight-line lettering.

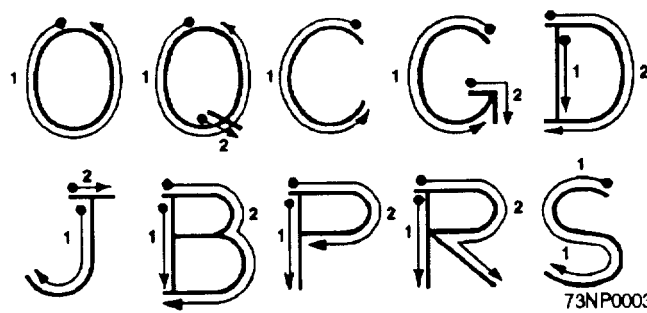

Figure 1-3.—Circular lettering.

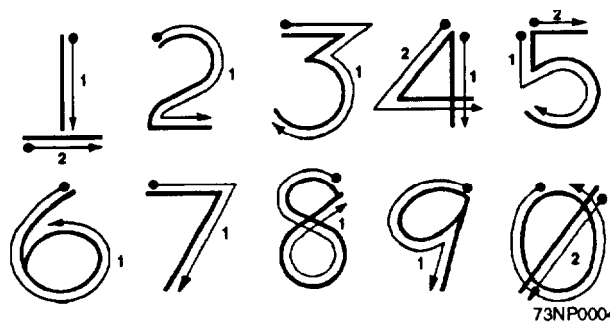

Figure 1-4.—Numerals.

Figure 1-1.—Phonetic and Morse code alphabet.

3. The top of 5 and 7, and the bottom of 2 are straight lines. The number 1 also has a straight line under it, slightly below the stem, to distinguish it from the letter *l*, and the zero has a bar diagonally through it (Ø) to distinguish it from the letter *O*. A horizontal bar through the riser of the letter **Z** helps prevent its being mistaken for the numeral 2.

The heavy dot at the end of each of the light lines, which parallel each letter and figure, indicates the starting point for the stroke. This dot and arrow indicate the direction in which the letter or figure is drawn. The numerals 1, 2, and 3 placed just beside each of the light lines indicate the number and the sequence in which the strokes of a letter or figure are made.

Practice printing the 26 alphabet letters and 10 numerals until you can make each character easily and legibly. Use a pencil with a good point, print each character carefully and accurately, and take care to have your printing evenly spaced. REMEMBER, the key to legible writing is practice.

The Message Blank

Once you have mastered the phonetic alphabet and practiced the principles of legible printing, the next step is to learn about the message blank. As illustrated in figure 1-5, a typical signal bridge message blank has spaces for the different parts of the message (the different parts are discussed in chapter 3). It is also broken down so that each group (for example, a complete word or code group) of the text has a separate space. This aids the counting of the groups. The well-trained recorder can tell at a glance if the message is complete.

FLAGBAG OPERATOR

"Stand by your bag" is a statement that is frequently heard on a signal bridge. As the flagbag operator, it is your duty to ready your flagbag.

To become an efficient flagbag operator takes work and practice; you must become familiar with the contents of the flagbag to the point that you can close your eyes and be able to locate the various flags.

VISUAL MESSAGE										
OPNAV FORM 2110-30 (10-58)										
Recorder from FPSO Cog. "I" stock points										
CALL UP										
HEADING										
										5
										10
										15
										20
										25
										30
										35
										40
										45
										50
										55
										60
FROM:					DATE			RELEASED BY		
TO:					SYSTEM			PRECEDENCE		
					OPERATOR			SUPERVISOR		
INFO:					TOR TOD			VISUAL HR		
FLAG	C OF S	CAPT	OOD	COMM. CEN.				DTG		

86NP0230

Figure 1-5.—Visual message blank.

SPOTTER

The spotter is the most valuable person in flaghoist communication. It is the spotter's job to get the signal hoisted and to make sure it is correct. To become a spotter, you must be able to recognize all flags in the flagbag without hesitation, know flaghoist terminology, and be able to read flaghoist in proper sequences. Spotter's duties and flaghoist terminology will be covered more in depth in chapter 5.

SEARCHLIGHT OPERATOR

Flashing light is used daily on the signal bridge. To become a searchlight operator, a Signalman must be efficient in Morse code. He or she must be knowledgeable in all procedures when communicating via flashing light. Searchlight operators must be able to energize equipment and to spot any malfunctions. Searchlight operator will be covered more in depth in chapter 4.

SEMAPHORE OPERATOR

Semaphore is a rapid and secure means of transmitting visual messages. It makes use of two hand flags (PAPA or OSCAR) attached to staffs about 22 inches long. This increases range of visibility. Semaphore may be used to send messages to several addresses at one time if they are positioned properly; because of its speed, it is better adapted for long messages. See appendix II for standard semaphore characters and a few helpful hints. Semaphore will be covered more in depth in chapter 4.

SIGNALMAN OF THE WATCH

No two signal bridges are run exactly the same; therefore, the duties of the Signalman of the watch will vary from ship to ship. The standard operating procedures (SOPs) on your signal bridge will define your duties as Signalman of the watch. In general, though, the Signalman of the watch, must be efficient in all forms of visual communication.

BOAT SIGNALMAN

Boat Signalman is one of your most important assignments; it usually comes in play to help save someone's life. Therefore, you must know all aspects of being a boat Signalman, including the identification of flares, directing boat by visual signaling, and being

able to operate a pyrotechnic kit. Boat Signalman procedures are discussed in chapter 8.

EXPERT LOOKOUT

On every ship, the lookout has an extremely important job. Even with today's radar, a good lookout is one of the OOD's most valuable sources of information. A Signalman's duties by nature also require keeping a sharp lookout. **As a matter of pride, the Signalman should be the first to sight and identify objects.**

An expert lookout has to be plenty sharp on a lot of things. Not only must lookouts be able to sight and identify objects, but they must be able to report them correctly, using relative bearings, distances, target angles, and in the case of aircraft, position angles. Lookout duties are covered in detail in chapter 8.

IN-PORT DUTY SIGNALMAN

The duties of the in-port duty Signalman include the holding of colors, sunrise, routing of visual messages, making preparations for getting under way, serving as a member of the rescue and assistance detail, and maintaining the visual station file and log.

The duties of the in-port duty Signalman will vary from ship to ship. Your SOPs will outline your duties.

SIGNALMAN SUPERVISOR

The Signalman supervisor is overall responsible to the leading Signalman and/or signal officer for the communication and conduct of personnel on watch. Signalman supervisor duties are discussed in chapter 8.

COMMUNICATIONS PUBLICATIONS

LEARNING OBJECTIVES: List 12 important communication publications and state the purpose of each. State how publications may be obtained. Explain the importance of publication corrections and changes, and state procedures for making publication changes.

A variety of special publications is necessary in visual communication. You will be using these pubs daily, so you may as well familiarize yourself with them at the start.

Basic Operational Communication Doctrine, NWP 4, forms the basic communication plan for the operating forces.

Naval Telecommunication Procedures Fleet Communication, NTP 4, supports and amplifies NWP 4. It contains substantially the same procedures and instructions issued in the JANAP (joint Army, Navy, Air Force publication) and ACP (allied communications publication) series. In the case of conflict between NTP 4 and the JANAP/ACP series, NTP 4 will govern for intra—U.S. Navy use.

NTP 4 furnishes the instructions for the employment of all phases of naval communication on both the command and operator levels. Additional instructions for joint operations are contained in JANAPs, while the ACPs contain instructions for the proper use of communication in joint, allied, and combined operations.

Although there are many JANAP/ACP publications, the publications that contain the final word about communication procedures are the JANAP/ACP 121 through 134 series. They are known as the communications instructions group.

Specifically, ACP 129, *Communication Instructions, Visual Communication Procedures*; ACP 121, *Communication Instruction, General Procedures*; and ACP 125, *Communication Instructions, Radiotelephone Procedure*, should be thoroughly understood by signal bridge personnel.

The Allied Maritime Tactical Signal Book, ATP 1, volume II, is a NATO restricted publication supplied to naval vessels. It contains maneuvering signals, standard operational signals, and the more common administrative signals. A thorough knowledge of the instructions in chapter 1 is a must for all Signalmen.

NTP 13, *Flags, Pennants, and Customs*, is an excellent source of information on all matters concerning flags and pennants.

The *International Code of Signals*, Pub 102, contains signals for use with merchant vessels of all nationalities. A knowledge of the instructions in the front of this pub is also a must for all Signalmen. Pub 102 also contains the Incidents On and Over the High Seas (INCSEA) agreement. This agreement between the U.S. and former Soviet countries helps to avoid the risk of collision at sea

ACP 131, *Communication Instructions, Operating Signals*, and ACP 168, *Pyrotechnic Signals*, also contain valuable information for visual communicators.

You should also familiarize yourself with the uses and contents of the following joint call sign books:

ACP 113, *Call Sign Book for Ships*

ACP 100 Series, *U.S./Allied Call Sign and Address System*

JANAP 119, *Joint Voice Call Sign Book*

OBTAINING PUBLICATIONS

These publications and most corrections and changes, with the exception of Pub 102, which is distributed by the Defense Mapping Agency Hydrographic Center (DMAHC), are made available to you through the technical publications librarian or the registered publications custodian.

PUBLICATION CORRECTIONS AND CHANGES

As a Signalman, you should be familiar with the system used for making corrections and changes to publications.

Each correction or change to a publication will have instructions for making the correction included in it. These instructions adequately describe the procedure to use. Read and thoroughly understand the instructions before you make the actual entry.

Since communications are in a constant state of flux, governing documents are subject to frequent changes. Unless otherwise stated, these changes are to be entered immediately, and the appropriate record sheet annotated. If new pages have been inserted, the publication must be thoroughly page checked.

Recommended changes to NTPs may be submitted using a feedback report (fig. 1-6). Changes of an urgent nature may be submitted by message. Correspondence regarding proposed changes to communications publications is submitted through the normal chain of command to the cognizant authority of the publication (found in the letter of promulgation).

Never use red ink when entering corrections. Normally, the only type of light you will use at night on the bridge is a red light. This light would render the red ink invisible, and you would be unable to read the

Communications Procedures Feedback Report

Date

From: _____

To: Commander, Naval Computer and Telecommunications Command (Code 31)
4401 Massachusetts Avenue, N.W.
Washington, D.C .20390-5290

Subj: Communications Procedures Feedback Report

Publication: _____

Paragraph No.: _____

Other: _____

Problem Areas: Typographical General Message
 New Procedures Other _____

Procedure is: Obsolete Inadequate Conflicting

Comments: _____

Figure 1-6.—Communications procedure feedback report.

corrections. If you have a quite lengthy pen-and-ink correction to make, it is better, both for neatness and legibility, to type it on a piece of paper and paste or tape it in. When you have a cutout correction to make (where you paste or tape the change to the old page of the pub), delete the superseded portion with, pen and ink.

ENERGIZING EQUIPMENT

LEARNING OBJECTIVES: Identify your responsibility regarding the location and operation of the ship's running lights.

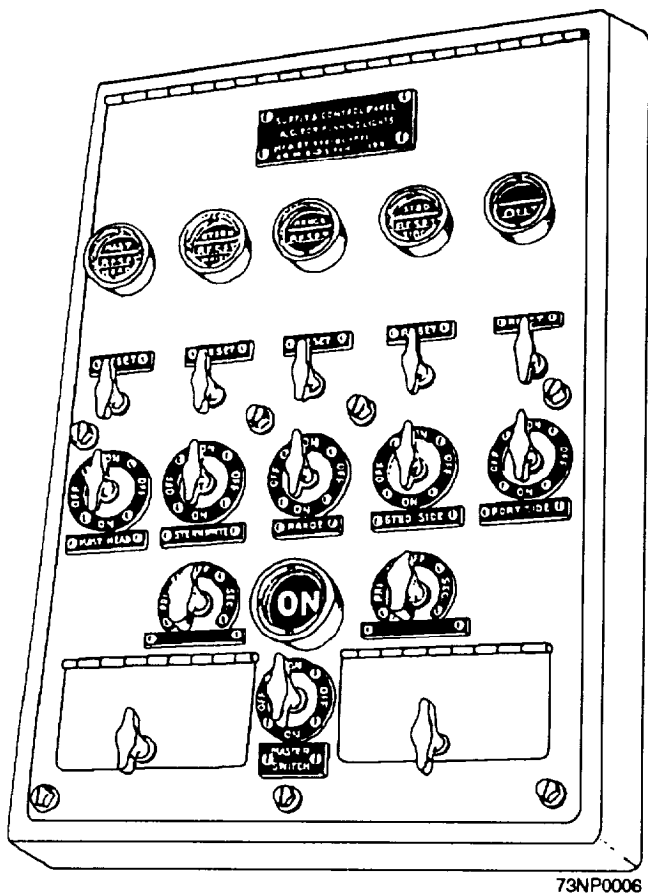

Figure 1-7.—Supply, control, and telltale panel.

The energizing of the signal searchlights, infrared, and other related equipment is covered in chapter 2. However, as a Signalmen, you should also know how to locate and operate the switches for your ship's running lights. You should be able to do this in the dark. The light panel, shown in figure 1-7, is located in the pilothouse; it controls the switches for the port and starboard running lights, towing lights, masthead light, second masthead light, and stern light. It affords an audible and visible signal when the primary

filament burns out in any of the five running lights. At the same time, it automatically switches to the secondary filament so that the defective light remains in service. Although the light remains in service on the secondary filament, the electrician should be notified so the defective lamp can be replaced at the earliest opportunity. In addition to the running light control panel, there is a signal and anchor light supply and control panel, also located in the pilothouse. The supply switches for these lights are individual **ON-OFF** rotary snap switches. This panel normally controls the aircraft warning lights, blinker lights, not-under-command lights, steering lights, stern light (blue), and wake lights.

The Not-Under-Command light switch is fitted with a crank handle to facilitate pulsating when the lights are used as a man overboard signal.

Learn where each individual switch is, and also where the master switch is located. In the event of an emergency, you must be able to turn the correct switch at the proper time.

SUMMARY

In this chapter you were informed of some of the many tasks that compile the Signalmen rating. These tasks ranged from sending and receiving messages by semaphore, flashing light, flaghoist, and radio, and lookout duties, to obtaining and updating publications. You were taught that to be successful you must be willing to work hard to master the varied skills used by Signalmen. You were reminded that your ability to perform your duties affects the operation of your ship, as well as other ships with whom you communicate. Your Navy and your Country need **TOP QUALITY SIGNALMEN**. Will you qualify?

CHAPTER 2

SIGNAL EQUIPMENT

Before Signalmen can perform their jobs, they must know the equipment with which they will work and how to operate it. Although equipment may differ in size or vary slightly among ships, signal gear generally is standard throughout the Navy.

In this chapter we discuss the principles of operation; maintenance procedures where applicable; and safety precautions pertaining to signal lights, infrared (IR) equipment, flags, halyards, and optical equipment.

You will not be permitted to use signal equipment until you have been instructed in the operation of it. The necessary permission must come from the communications (or signal) officer or the petty officer in charge of the signal bridge.

You must be able to locate, even under conditions of total darkness, all light switches for electrical visual signal equipment. Usually this is simply a matter of familiarization. On the signal bridge most switches are on or within reach of the equipment. When you first report aboard ship, explore the bridge to see where the signal equipment switch panels are located. Do this before your watch. This practice will prove helpful later when you are scheduled for night watches.

SIGNAL SEARCHLIGHTS

LEARNING OBJECTIVES: Describe the different types of signaling searchlights. Identify their parts and assemblies and explain their functions.

Searchlights are placed aboard naval ships for two purposes: illumination and communications. The use of a searchlight in visual communications is called the directional method, because the light has to be pointed at the receiver. Searchlights are classified according to size and source. We discuss the 12-inch searchlights in this chapter. The 12-inch light is either an incandescent or mercury-xenon arc lamp.

Searchlights come under the cognizance of the Naval Sea Systems Command (NAVSEASYS COM), and the ship's engineer officer is responsible for their

repair. That does not, however, relieve the Signalman of the full responsibility for observing the instructions for the proper use and routine maintenance of the searchlights. The life of a searchlight depends upon the care given to it. Preventive maintenance and daily cleaning will keep your searchlight ready for instant use.

Searchlights used in the Navy normally use a shutter to interrupt the light beam and permit signaling. The patterns of light caused by the opening and closing of the shutter are the basis for transmitting messages by Morse code.

12-INCH INCANDESCENT SEARCHLIGHT

The 12-inch incandescent searchlight is used primarily for signaling and secondarily for illumination.

Figure 2-1 shows a 12-inch incandescent searchlight, consisting of the mounting bracket, lamp-supporting yoke, and high-power (1,000-watt) incandescent lamp housed in a drum. By use of a brace or extension between the mounting bracket and the yoke, the light can be swung in an arc to clear fixed portions of the ship's structure.

Besides holding the lamp, the drum provides a mounting for the signaling shutters. On top of the drum are vane sights, used to aim the light. The back

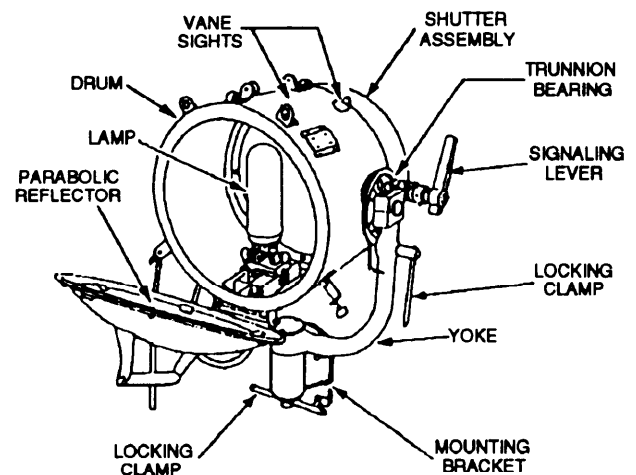

Figure 2-1.—12-inch incandescent searchlight.

door is hinged, allowing access to the drum interior. The parabolic reflector is mounted on the rear door. Signaling levers on both sides of the drum open and close the shutters to permit signaling up to 15 words per minute.

The drum is mounted on the yoke with trunion bearings so that the light can be elevated or depressed. Locking clamps on the yoke secure the light in elevation; locking clamps beneath the mounting bracket lock the light in train.

There is very little to operating this type of light. You can learn in a short time the proper procedure for turning the lamp on and off, positioning it horizontally or vertically, and operating the shutter. Train the searchlight directly on the receiver in daytime, but not at night, for it might blind the receiver and bridge personnel. At night, train the searchlight slightly under or above the receiver.

Operation

A remotely mounted rotary switch controls power to the searchlight. To open the signaling shutters, use pressure on the signaling lever to overcome spring pressure. When you release pressure on the signaling lever, the spring forces the shutters closed. Two leather bumpers cushion the return of the signaling lever, protecting the shutter from damage.

Do not keep the searchlight switched on longer than necessary. When the searchlight is not in use, lock it in the fore-and-aft position.

When the signal bridge is secured, as during overhaul, searchlight lay-up maintenance should be conducted according to the maintenance requirement card (MRC); also, all tests and care and maintenance procedures should be performed before redeployment, to ensure proper operation. During inclement weather, place a protective canvas cover over lights not in use.

Maintenance

Maintain searchlights according to current MRCs. Electrical contacts must be kept clean and bright. Electrical leads should be checked daily and replaced as soon as defects appear. Depending on the amount of time they are used, moving parts such as trunion bearings and stanchion sockets must be lubricated at intervals. Shutter vane hinges and links should be lubricated once a quarter, or more frequently if required. Searchlights should be operated for a few

minutes after lubrication with the door glass and cover removed to allow the lubricant to evaporate.

Screws and bolts should be checked for tightness at regular intervals, particularly following the firing of the ship's guns.

The two shutter stop screws should be adjusted at regular intervals to take up the wear in the leather bumpers. The leather bumper should just touch the stop adjustment when the vanes are closed to prevent twisting.

The reflector should be cleaned quarterly and/or when needed. Refer to your MRC for instructions on cleaning the reflector.

Never paint a bearing surface or the working member of any part of the light. Do not paint bolts, locking nuts, or other parts accessing the interior. Do not paint over nameplates, and keep oiling cups and holes free of paint.

Replacing the lamp and focusing should be done only by qualified Electrician's Mates unless a member of the signal gang is qualified and authorized to do so.

12-INCH MERCURY-XENON ARC SEARCHLIGHT

The mercury-xenon arc searchlight uses a 1,000-watt mercury-xenon lamp. The searchlight is provided with an automatic lamp-starting circuit.

Parts consist of a drum, back dome, signaling shutter, mounting yoke, lamp, focusing device, starter box, and ballast assembly. The automatic starting circuit assembly is attached to the lower part of the drum. A screening hood with various color filters is supplied.

A high-voltage, pulse-type circuit is used. When the searchlight is turned on, the boost transformer supplies 130 volts to the primary coil of the transformer, which in turn provides a series of pulses of approximately 50,000 volts generated by high-frequency discharges through a spark gap.

When the main arc in the lamp is established, the voltage to the primary coil of the transformer drops to 65 volts. This voltage is not high enough to cause the secondary voltage of the transformer to break down the spark gap. Thus, the high-voltage pulse to the lamp automatically ceases.

Five resistors are connected in parallel and are, in turn, connected in series with the lamp. These resistors limit the current at starting and during operation, and supply the correct electrical values to the lamp.

12-INCH MODIFIED MERCURY-XENON SEARCHLIGHT

Some of the older mercury-xenon searchlights are 12-inch, incandescent lamp searchlights converted to use a 1,000-watt, compact, mercury-xenon arc lamp (fig. 2-2). The addition of a small amount of mercury to xenon in a gaseous discharge arc lamp produces a much more brilliant light with a great deal of radiation in the green and ultraviolet parts of the spectrum. The increase in light intensity greatly increases the range of the searchlights.

The modifications made to convert the searchlight include the installation of a lamp holder, lamp adjuster assembly, and lamp starter assembly mounted on the searchlight drum.

Other modifications include the following:

1. Providing a 115-volt, 60-Hz ballast unit to be mounted below the deck near the searchlight and connected to it by a flexible cable.
2. Installing the short-arc mercury-xenon lamp.
3. Furnishing the additional onboard repair parts necessitated by the changes. (The electrical components include a ballast, transformers, capacitors, spark gaps, and switch circuits.)

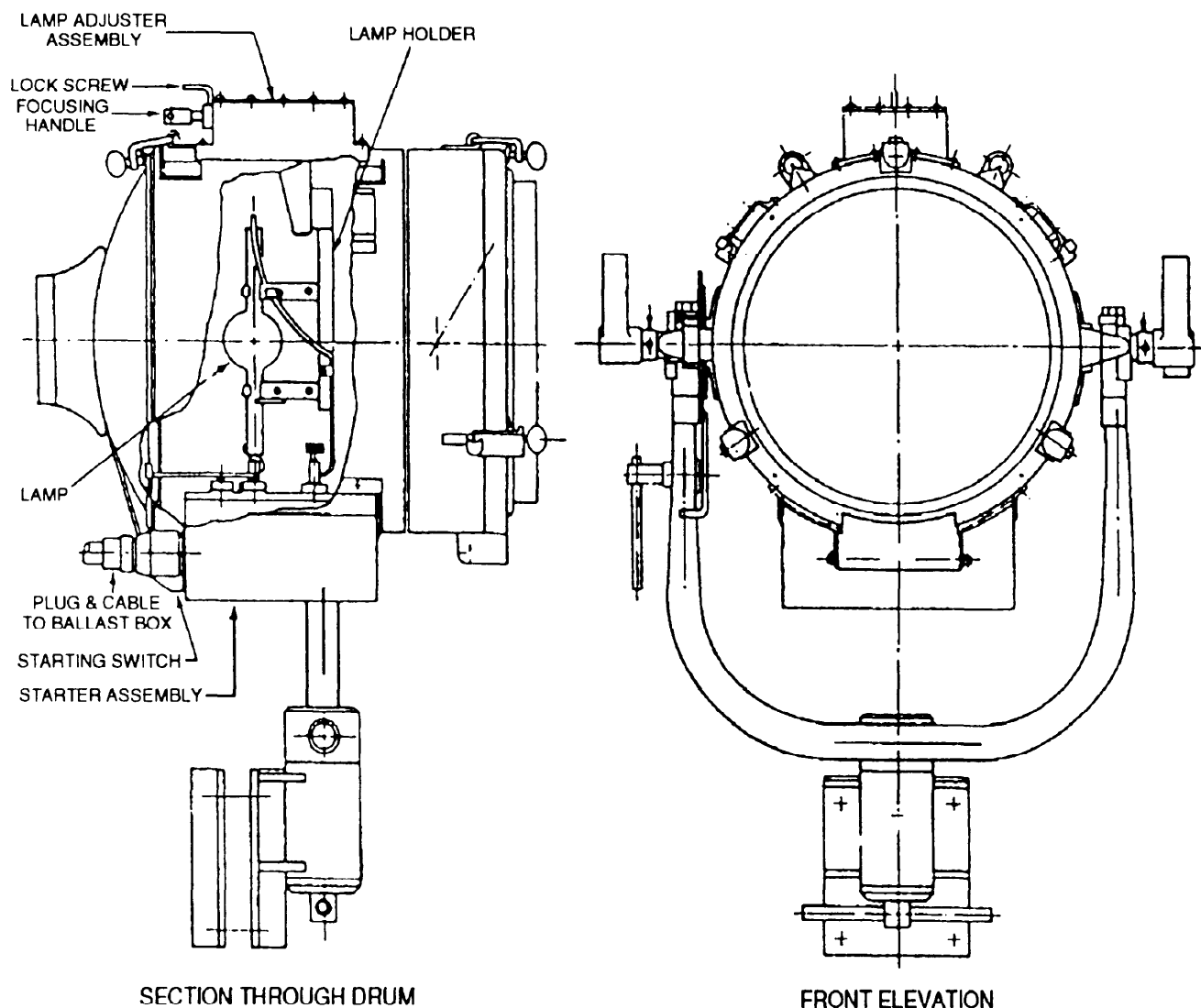

Figure 2-2.—12-inch modified mercury-xenon arc searchlight.

73NP0008

Operation

To start the light, close the remote manual switch, then turn the starter counterclockwise on the rear of the starter unit. (See fig. 2-3.) Release the starter switch as soon as the lamp arcs. Be sure the starter switch returns to its previous position; otherwise, the higher current required to start the lamp may damage electrical components.

Initially, the lamp burns only at about 25 percent of designed intensity. It takes 2 to 3 minutes to reach maximum brilliance.

The light should not be elevated or depressed more than 10 degrees for extended periods of time because the life of the lamp is reduced considerably at extreme angles. Operate the shutters the same as you would the incandescent lamp shutters. To turn off the lamp, open the remote manual switch.

Maintenance

The 12-inch mercury-xenon arc searchlight should be inspected and checked monthly. All screws, especially those of the reflector clamps, focusing mount, and lamp support, should be examined for looseness. All screws and fastenings should be checked after ship's guns have been fired.

Trunion and yoke bearings should be lubricated with grease; see the MRC for the type of grease.

Replacement of the lamp must be performed as explained in the applicable manufacturer's manual, observing all precautions given.

When the return action becomes sluggish, the shutter bearing and links should be lubricated. The lubricant should be used sparingly and should not be allowed to contact the envelope of the mercury-xenon lamp. Should the shutters remain sluggish, replace the shutter springs.

The reflector and glass cover should be cleaned as required by the MRC.

When considered necessary, the cover of the ballast box should be removed and the five resistors examined and tightened in their sockets. Wiring should be checked and terminal screws tightened as required. The packing glands at the cable entrances should be kept secure and watertight.

Focusing is performed by means of a sliding plunger at the rear of the focusing box on top of the searchlight.

Maintenance is basically the same for the manual-starting and automatic-starting, 12-inch, mercury-xenon searchlights. For detailed differences in the construction and operation of these two types, see the applicable manufacturer's manual.

Electrical maintenance should be left to the electricians unless a member of the signal gang is qualified to do it by the engineer officer.

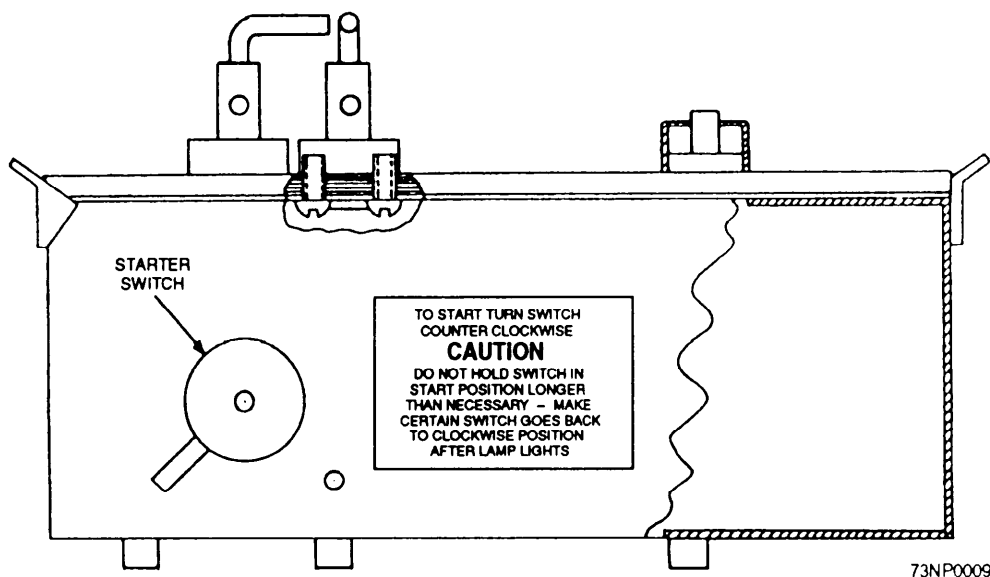

Figure 2-3.—Starter unit for 12-inch mercury-xenon searchlight.

Because the lamp contains gas under pressure, take care when handling it or when cleaning the interior of the drum. The lamp shell is quartz, not glass. Keep it free of oil or grease, and do not handle it without the protective metal case provided. Grease or oil may, at lamp operating temperatures, set up stresses in the quartz and cause the lamp to explode. If the lamp should be soiled in any way, wash it off with alcohol or other grease-free solvent, then dry it carefully with a clean cloth.

Before opening the drum, make sure the power is off. This can be done by turning the remote switch OFF and then removing the power cable plug from the starter unit.

When you remove or replace the lamp, wear the face guard and gloves provided. Place the protective metal guard over the lamp; disconnect the lamp leads from the binding post on top of the starter unit; loosen all wing nuts holding the lamp in the lamp adjuster assembly; then remove the lamp.

CAUTION

Even when it reaches the end of its useful life, a mercury-xenon lamp is potentially dangerous. Turn it in to the mercury control officer or his/her representative for disposal.

When installing a new lamp, do not touch the quartz with your fingers. Keep the protective case around the lamp until it is in place.

Hold the lamp by the protective cover with the longer of the two leads pointing up, and insert them in the two vee-slots on the lamp supports. Fasten the lamp in place with the clamps and wing nuts; then connect the power leads to the binding post, making sure they do not touch any other metal parts.

For signaling at the greater design ranges, more accuracy in the aim is required. To align the sights with the beam, aim the light at a bulkhead 50 to 100 feet away. Focus the lamp for the narrow beam. Look through the sights; the beam should be in the center.

If the beam is not centered, remove the top cover plate of the lamp adjuster assembly. (See fig. 2-4.) If the beam is high or low, loosen the thumbscrew and turn the vertical adjustment screw to raise or lower the lamp. When you have it adjusted, tighten the thumbscrew. If the beam is off to one side, loosen the four horizontal screws on the transverse sliding plate;

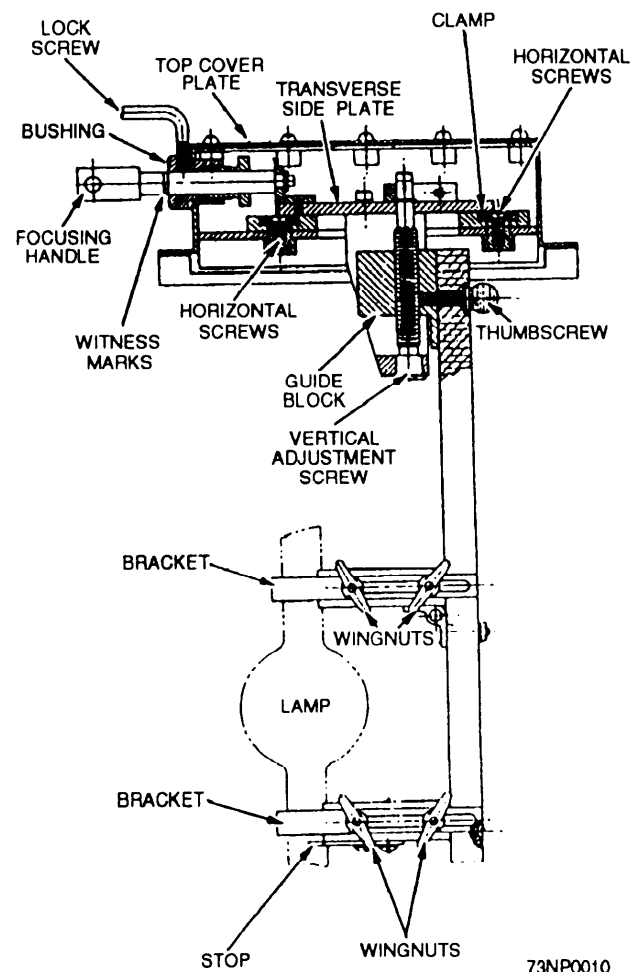

Figure 2-4.—12-inch mercury-xenon lamp adjuster assembly.

slide the plate by hand to center the beam; and retighten the screws.

MULTIPURPOSE SIGNAL LIGHT

The multipurpose signal light (fig. 2-5) produces a high-intensity beam of light suitable for use as a spotlight or as a blinker for visual communication. The power source is three dry cell batteries or the ship's electrical power via a 120/20-volt transformer mounted in the storage box. The front handle is adjustable to maintain a steady position when signaling, and front and rear sights are provided for holding the beam on target.

Supplied with the light are red, green, and amber lenses, a 15-foot power cord for supplying power from the ship's electrical source to the storage box, and a 25-foot cord for supplying power from the storage box to the light.

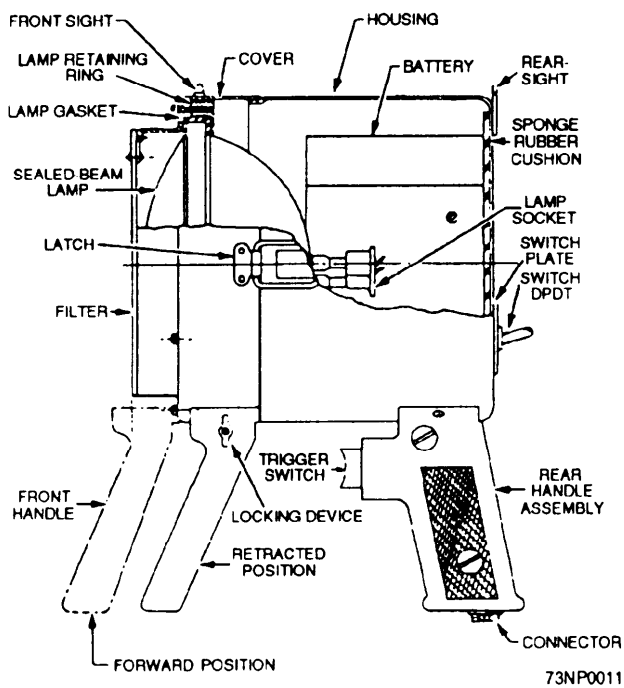

Figure 2-5.—Multipurpose signal light.

For signaling, the light may be held in the hand and operated with the trigger. It has an effective signaling range of 4,000 yards and is designed to send up to 12 words per minute.

YARDARM BLINKERS SYSTEM

LEARNING OBJECTIVE: Explain the function of the yardarm blinkers system.

Yardarm blinkers are 32-point, 360-degree white lights located on the yardarm or on separate supports on the mast. (See fig. 2-6.) The fixtures are spraytight and fitted with screens at their bases to prevent glare or reflection, which could interfere with navigation. The range of the yardarm blinkers is limited and can only be used effectively during hours of darkness.

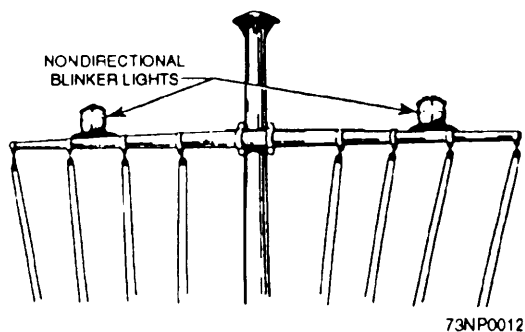

Figure 2-6.—Yardarm blinkers.

Yardarm blinkers permit communication to several units simultaneously. These lights are operated from signal keys located on each side of the signal bridge and in the signal shelter. By selecting the appropriate position on the transmitter control panel, you can operate the beacons as a steady light or as blinkers using the signal key.

Normally, maintenance is the responsibility of the Electrician's Mates. Cleanliness and upkeep of the light exteriors are tasks for Signalmen. This upkeep can be hazardous. Before going aloft, check Man Aloft Procedures covered later in this chapter.

INFRARED COMMUNICATION EQUIPMENT

LEARNING OBJECTIVE: Explain the function of infrared (IR) transmitting sets.

Infrared equipment consists of the AN/SAT 2 IR transmitting set or a searchlight fitted with an H hood. This equipment is popularly known as Nancy gear. Night vision sights (NVSS) make it possible to visually detect the invisible IR rays of the light spectrum. Together this equipment provides a measure of communication security.

Like visible light, IR is limited in range to the horizon, and range is further reduced by adverse weather conditions.

AN/SAT 2 TRANSMITTING SET

The AN/SAT 2 IR transmitting set (see fig. 2-7) is designed to transmit signals in the IR region of the frequency spectrum; that is, between 0.75 and 1.2 microns. Infrared radiations are invisible, thus providing a secure means for signaling at night under darkened ship conditions. The two IR transmitters (beacons) may be operated as a steady source for point-of-train purposes, or they may be flashed in Morse code for signaling and recognition. The beacons are visible for 360 degrees and can be positioned to transmit fore and aft or port and starboard. For security, the beacons have been designed so they cannot be detected by the unaided eye at distances greater than 400 yards. The beacons are white-light tight; however, they are visible as dim red lights at short distances. The AN/SAT 2 is used mainly for nondirectional communication.

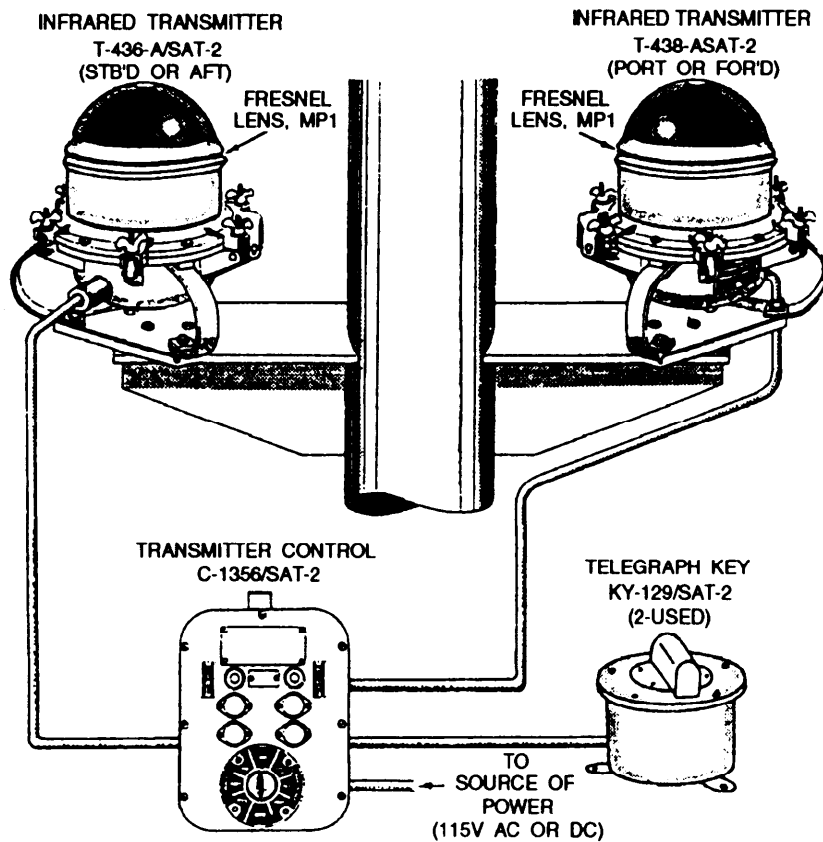

Figure 2-7.—AN/SAT 2 infrared transmitting set.

The IR transmitting set consists of two IR transmitters (beacons), a transmitter control panel, and two telegraph keys. The beacons may be operated separately or simultaneously by either manual key. Selection of the mode of operation is controlled by the transmitter control panel. The IR transmitter consists of a formed brass housing and a dome-shaped homogeneous tempered glass filter, which encloses a 300-watt, 110-volt, T20 clear bulb incandescent lamp and reflector. The transmitter control consists of a watertight brass housing with a removable front cover, and contains a switch, four fuses, two indicator lights, two terminal boards, and associated wiring. The front panel has a gasket to ensure a watertight fit, and is fastened to the housing by means of eight machine screws. Two locating pins ensure proper alignment of the door and housing. (This control panel is also utilized by the yardarm blinkers; however, this blinker is powered by a separate ship's power supply to ensure the circuit is inoperable during darken ship.) The telegraph key consists of a watertight brass box containing a signaling key, a monitor indicator light, a terminal board, and a capacitor. The watertight housing consists of a formed and welded steel box with a formed steel cover and key guard. The cover is

attached to the housing by means of six machine screws. A locating pin ensures proper alignment. The base of the housing has three mounting lugs. The hinged key guard on the cover protects the key from damage when it is not in use. A hold-down lever permits steady operation of the beacons when placed in the down position.

Due to the constant exposure to the elements, strict compliance with planned maintenance system (PMS) requirements is essential for this equipment. Normally, maintenance is the responsibility of the Electrician's Mates. Cleanliness and upkeep of the light exteriors are tasks for Signalmen. This upkeep can be hazardous. Before going aloft, check Man Aloft Procedures covered later in this chapter.

The most widely used IR transmitting equipment is the standard 12-inch searchlight fitted with a type-H hood containing the special filter lens (fig. 2-8). The lens resembles a sheet of red glass. The light is operated in the same procedure for regular directional communication, but train must be more accurate.

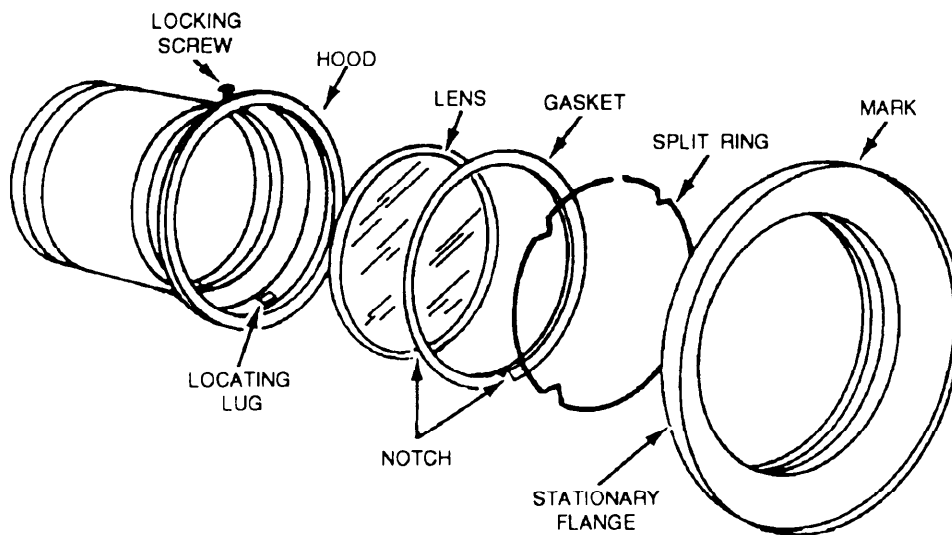

73NP0014

Figure 2-8.—Searchlight H hood.

CHEMICAL WARFARE DIRECTIONAL DETECTOR

LEARNING OBJECTIVE: Explain the procedures for the use of the chemical warfare (CW) directional detector, including installation, maintenance, and operations.

The AN/KAS-1 chemical warfare directional detector system (fig. 2-9) is a passive IR imaging sensor that provides U.S. Navy ships with the capability for detection and identification of chemical warfare (CW) agent attacks. The AN/KAS-1 can be used to detect and identify nerve agent attacks against ships in a task force, against waves of amphibious assault ships/boats proceeding ashore, or against assault forces in the vicinity of the landing area. Chemical warfare agent cloud detection and identification can be accomplished against a sky background for all conditions under which CW attacks may be expected to occur. Detection of CW activity against a land background can be accomplished less effectively.

The inherent characteristics of an IR sensor make the AN/KAS-1 useful in low-visibility/night pilotage and area surveillance. The AN/KAS-1 operator can detect and provide relative bearing to prominent land features (light house, water tower) and buoys. Detection of personnel on the water surface (man overboard) can also be provided by the system.

The AN/KAS-1 consists of a sensor unit, a pivot mount, a power conversion unit (PCU), a carrying/stowage case, a maintenance kit, and an overboard lanyard.

The sensor unit is equipped with the following controls: a field-of-view switch, which enables the operator to use both a wide field of view (WFOV) and a narrow field of view (NFOV); a range/focus knob; a contrast knob; a brightness knob; and a filter wheel switch. The filter wheel switch allows the operator to rotate a wheel positioned in the optical chain of the unit through four positions: filter 1, filter 2, filter 3, and filter out. These filters are used to identify CW nerve agent clouds.

The pivot mount provides the mechanical interface between the sensor unit and the standard bracket and lock assembly. The pivot mount provides a minimum elevation of minus 35 degrees to plus 45 degrees and 360 degrees of azimuth; the number of azimuth rotations is limited only by the length of the interconnecting cable. Handlebars are provided for operator positioning of the sensor unit. The interconnecting cable provides electrical connection/power transfer from the PCU to the sensor unit via a coiled, double-shielded cable.

The PCU (fig. 2-10) provides operating power to the sensor from the ship's 115-Vac, 60-Hz supply. Press-to-test switches/lights are included to verify the presence of input and output voltages. The unit consists of an electronics tray contained in a watertight protective housing.

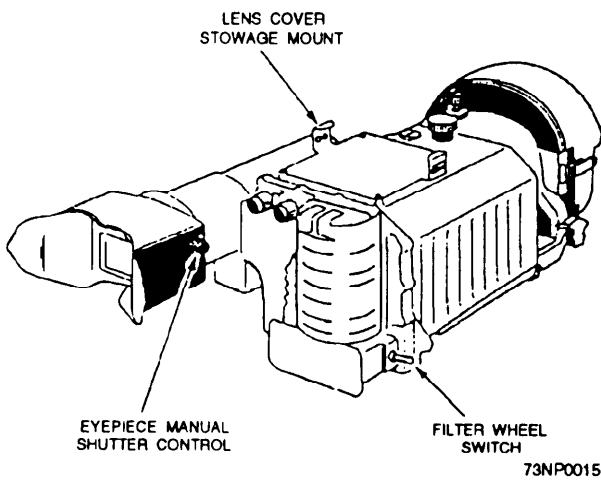
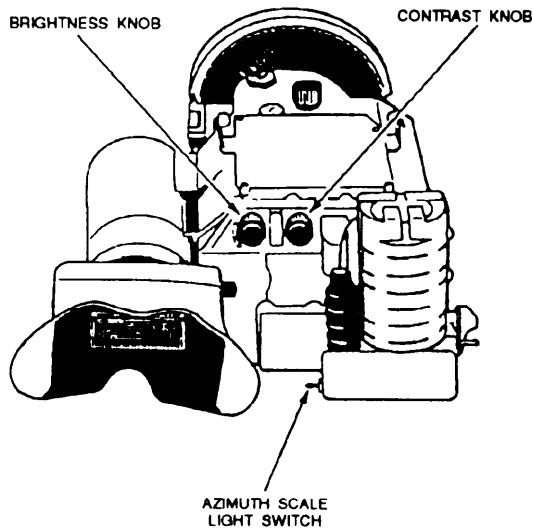
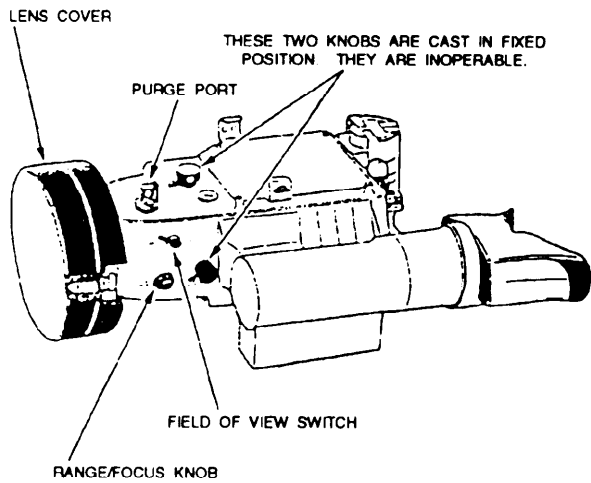

Figure 2-9.—Chemical warfare directional detector.

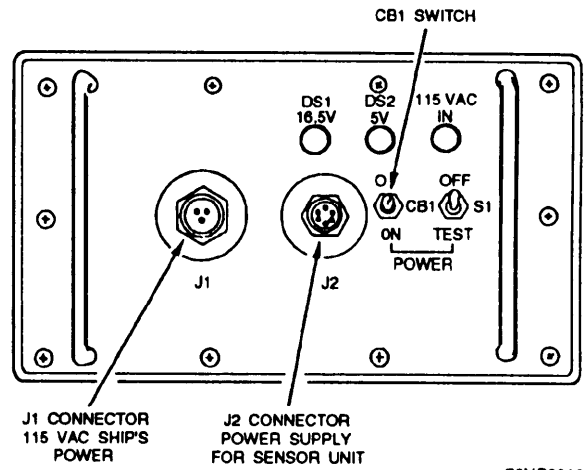

Figure 2-10.—Power conversion unit.

A carrying/storage case is provided for transportation and storage of the AN/KAS-1. Space is also provided in the case for the storage of the sensor unit, pivot mount, interconnecting cables, overboard lanyard, maintenance kit, and foul-weather cover.

A foul-weather cover of waterproof canvas is used for protecting the sensor pivot mount when it is not in use.

A maintenance kit (fig. 2-11) (stowed inside the carrying/storage case) is provided with the AN/KAS-1. The kit consists of the following:

1. Spare bulbs and lenses

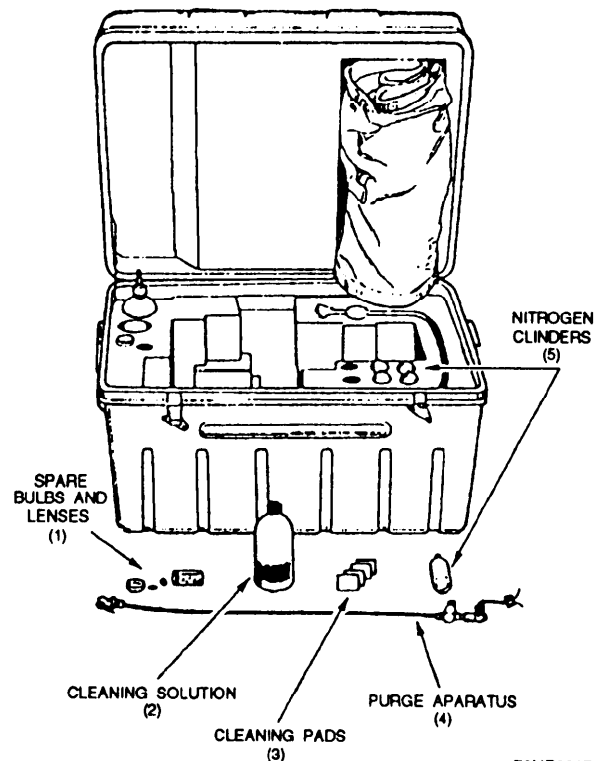

Figure 2-11.—Maintenance kit.

2. Lens-cleaning solution
3. Lens wipers
4. Purge kit regulator/connector assembly
5. Expendable nitrogen gas cartridges (six) to purge the sensor unit of moisture (30-day requirement)

An overboard lanyard (vinyl-covered stainless steel cable) is used to secure the sensor/pivot mount to an eyelet on the PCU unit mounting plate prior to installation or removal. The overboard lanyard and associated safety procedures will prevent accidental over-the-side loss or severe damage (fall to a lower deck) during installation or removal.

INSTALLATION

Two mounting locations are to be established for each AN/KAS-1 (fig. 2-12). Each location should be carefully chosen to ensure that it has a wide field of view (the view as wide as possible, and not blocked by other hardware). Care must be taken to avoid interference with other ships' equipment. Locations already selected for the Mk 37 night vision sight (NVS) are usually excellent. When possible, the mounting locations should be high on the ship, such as the signal bridge or pilothouse bridge wings. The locations must be accessible to sound-powered headphones.

The PCU mounting plate installation requires separation distance between the sensor unit and the PCU, and between the PCU and the deck when the PCU is mounted near the AN/KAS-1. These separation distances are necessary to ensure that the power cable will be neither too short nor too long and thereby create entanglement.

MAINTENANCE

The AN/KAS-1 has been designed for minimum maintenance. Scheduled maintenance procedures will be detailed on the MRC. Corrective maintenance consists of removal and replacement of the sensor/pivot unit or the PCU when a failure occurs. The failure will be handled on a repair-and-return basis and does not require a requisition for replacement.

TRAINING

Each AN/KAS-1 received will have a complete training package. This training should be incorporated into the Signaller Personnel Qualification Standards (PQS).

OPTICAL EQUIPMENT

LEARNING OBJECTIVES: Identify optical equipment. List procedures for the operation, maintenance, and handling of optical equipment.

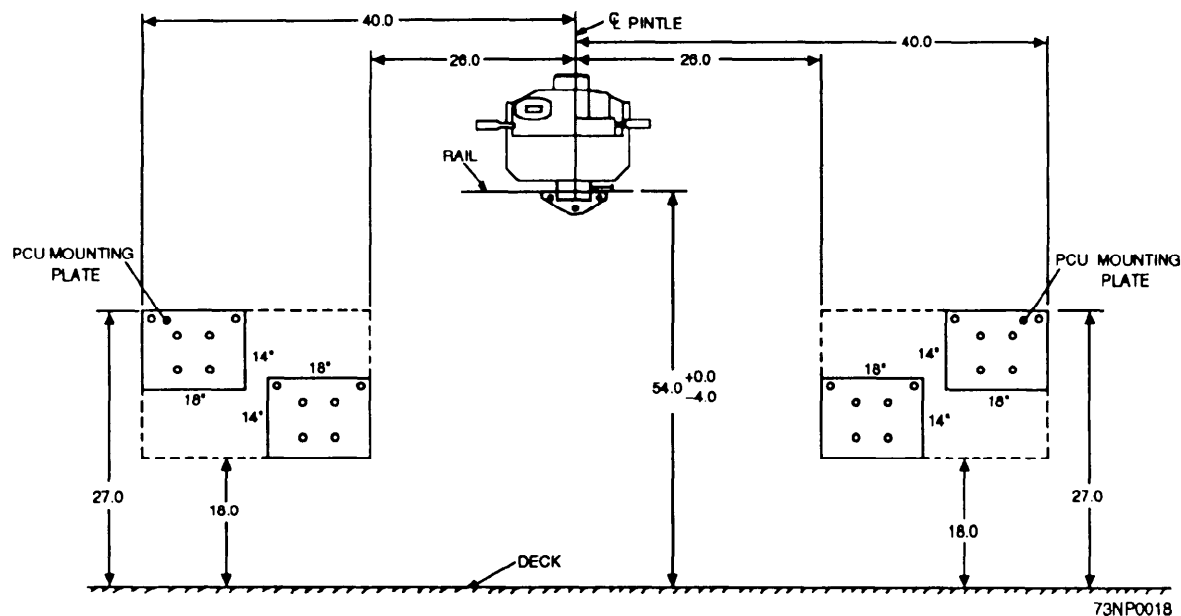

Figure 2-12.—AN/KAS-1 system installation.

73NP0018

You were born with the finest optical equipment you will ever use—your eyes. But even if you have 20-20 vision, it often is impossible to read flaghoist and other signals accurately with the naked eye. To magnify distant signals, some of the following aids to vision are carried aboard Navy ships.

SHIP'S BINOCULARS

Ship's binoculars (known as big eyes) have a magnification of 20-power, with an apparent field of view of approximately 70 degrees. The binoculars are mounted on a height-adjustable carriage assembly that is adjustable through 70 degrees elevation ranging from 10 degrees depression to 60 degrees elevation with reference to the horizon, and that can rotate through 360 degrees in azimuth. Ship's binoculars consist of the binocular assembly, carriage assembly, and the pedestal (fig. 2-13).

The binocular assembly contains the optics required to obtain the desired magnification. Eyeguards are provided to keep stray light from the observer's eye when sighting through the eyepiece.

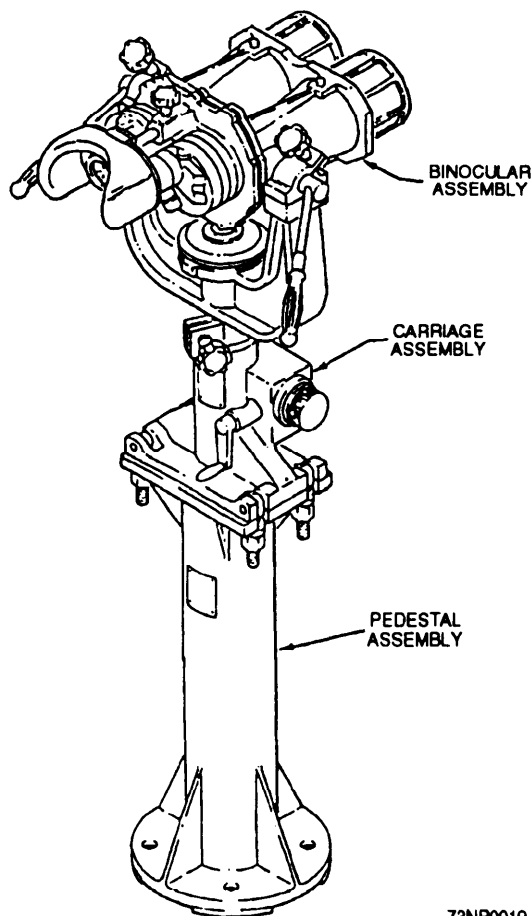

Figure 2-13.—Ship's binoculars.

73NP0019

The focusing knob enables the eyepiece to be individually adjusted. Each focusing knob is provided with a diopter scale, which is graduated from -3 to +1 in 1/2-diopter increments. The interpupillary distance (IPD) of the eyepieces is controlled by an interocular handle, and is adjustable from 56 to 74 millimeters. An INCREASE-DENSITY control is provided to adjust the polarized light filter. Inlet and outlet valves, located on top of the main housing assembly, are provided to evacuate and recharge the binocular assembly with dry nitrogen.

The carriage assembly enables the binocular assembly to be positioned in the proper azimuth and elevation. The carriage assembly contains a 360-degree azimuth scale graduated in 1-degree increments. The binoculars may be locked in any position from minus 10 degrees to plus 60 degrees by the elevation or azimuth knobs. The carriage also contains a handcrank that allows vertical adjustment of the binocular assembly through a range of 8 inches.

The pedestal assembly is used to mount the binoculars to the deck

Operation

Perform the following procedures to operate the ship's binoculars (fig. 2-14):

1. Using the elevation handle, crank the binocular assembly to the desired height.
2. Loosen the headrest assembly knob and adjust the headrest to obtain proper relief and to center your eyes before the eyepieces. Tighten in position.
3. Adjust the interocular adjust knob until the same field is visible in both eyepieces.
4. Loosen the azimuth carriage and binocular elevation lock knobs; using the control handles, maneuver the binoculars in either azimuth or elevation so that the rear sight and front pin are trained on the object.
5. Rotate the variable-density control knob to remove the density filter from the optical path.
6. Individually move an eyepiece to the extreme plus diopter setting. Place your eyes into position and slowly move the eyepiece in until the image of the target is clearly defined. If the eyepiece is allowed to go past sharp definition, do not refocus; start over. Memorize your diopter scale readings. These readings can be used to make future focusing adjustments.

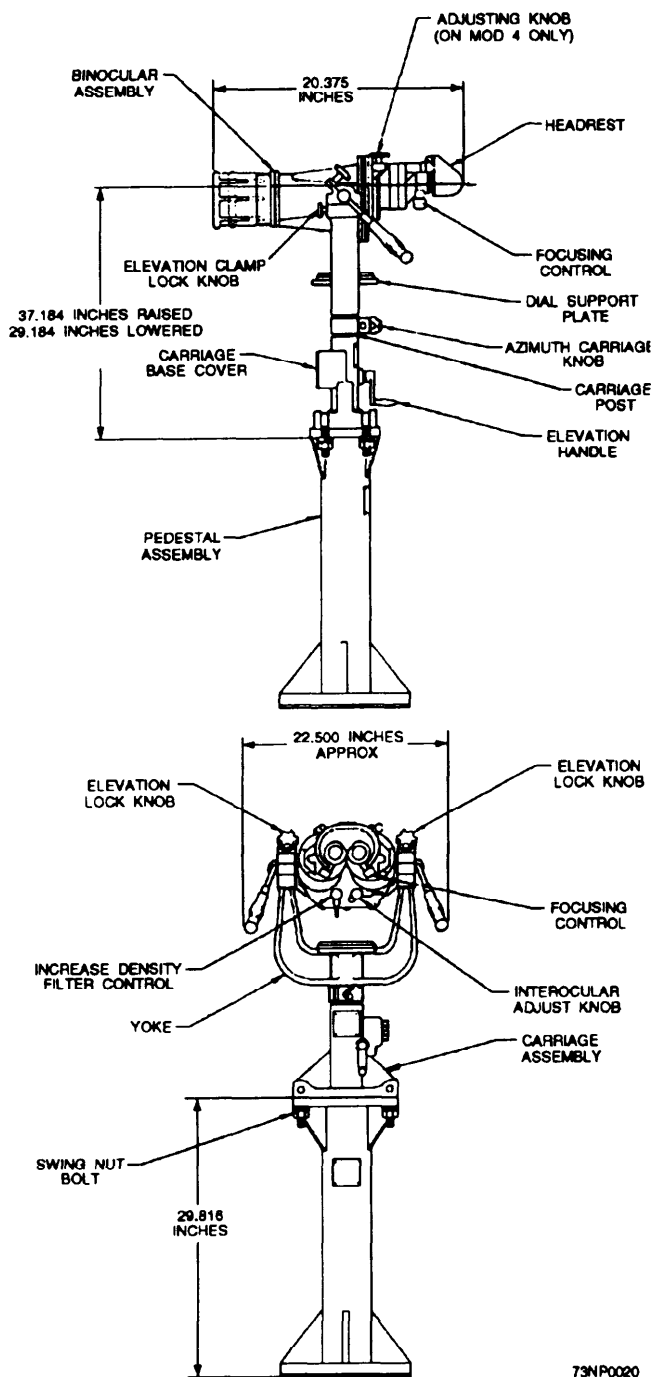

Figure 2-14.—Ship's binoculars arrangement and operating controls.

7. Rotate the variable-density control knob to control light and glare from the target field. Full clockwise rotation of the knob brings the polarizing filter, aligned for maximum light transmission, into the light paths. Gradual counterclockwise turns reduce light transmission to the minimum.

8. To lock the binocular assembly in the desired position, tighten the azimuth carriage and carriage assembly elevation lock knobs. A slight amount of friction may be introduced by leaving the elevation lock knobs slightly loose.

When the binocular is not in use, lower the carriage to its lowest position, secure all locks, and install the canvas cover over the binocular assembly.

Maintenance

Maintenance should be performed according to the MRC. Scheduled maintenance includes routine inspection, cleaning, lubrication, and adjustments that can be made without removing the binoculars from the ship.

CAUTION

The optical parts sealed within the body of binoculars may be seriously damaged by contamination if the body seal is broken. Any repair or adjustment requiring opening the body should be made by the appropriate facility.

Ship binoculars should be inspected daily to make sure they are in good working order both optically and mechanically. This includes checking the locking mechanisms, elevation, and rotation; external surfaces; rubber components for deterioration; and all controls to ensure a snug fit between their respective shafts and preformed packing.

The objective and eyepiece lenses are to be cleaned using appropriate cleaning material according to the MRC. However, unnecessary cleaning should be avoided. Wipe the metal parts of the binoculars with fresh water and detergent to prevent accumulation of salt and dirt.

When lubricating, remove the old lubricant and residue. Apply new lubricant sparingly as required. The angular elevation clamp, round boss, and lock pin should be lubricated at each removal or replacement. Remove the access cover to lubricate the gear

assembly. Take care to keep lubricant from the friction disc and the locking surfaces. Lubricate the yoke assembly by removing the binocular and removing the three screws and lift dial support; then lift the yoke from the carriage post and lightly coat the interior bearing surface of the yoke.

CAUTION

Two persons should be used to lift either the binocular or yoke assembly.

BINOCULARS

Binoculars (fig. 2-15) are the most commonly used of all optical equipment. Although normally only 7-power, they give a wide range of vision and are best suited for searching over a wide area or for following moving targets. They require the use of both eyes and, because both eyes do not always have the same vision, it is better to adjust the focus for each lens individually. Proper focus is essential. If the focus is off, eyestrain is increased greatly, and you will not get maximum efficiency from your optics.

To obtain the proper focus for each eye, turn both binocular scales to the +4 setting. Hold the binoculars firmly against your eyebrows. To get the focus for your left eye (only one eye can be focused at a time), cup the right hand over the right lens, cutting all light to that eye. Be sure to keep both eyes open, however, because closing one eye will give an incorrect focus. Train the binocular on a small well-defined object.

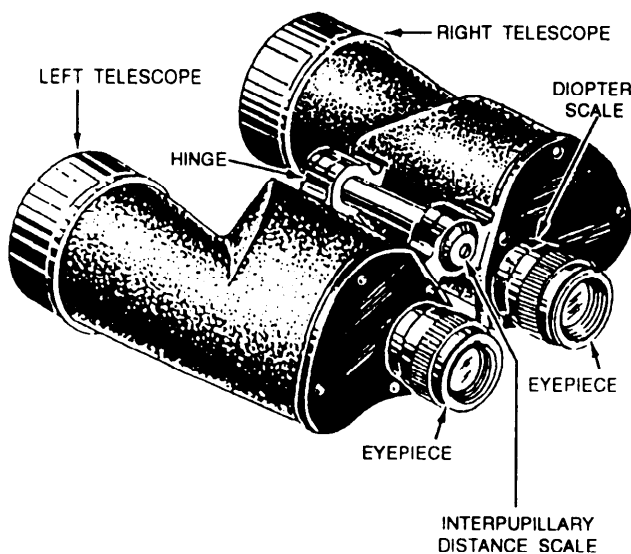

73NP0021

Figure 2-15.—7 × 50 binoculars.

Slowly turn the eyepiece from the +4 setting until the object stands out in sharp detail.

The reading on the scale gives you the correct focus for your left eye. Now do the same for your right eye. The chances are the setting will be different. Repeat this step several times to make sure the focuses are correct.

Once you get the glasses focused properly, remember your settings so you can focus your binoculars on a very dark night. The correct night focus usually is a -1 setting from your day focus for each eye.

The other adjustment for binoculars is the IPD adjustment. All Navy binoculars have the IPD scale on the hinges between the barrels. Find out what your IPD is and remember it. It may already be in your health record. If not, have a medical officer measure you for it. When you have set your correct IPD scale, you will see a complete circle, never overlapping circles. At night, if you have the wrong IPD setting, you will cut out a lot of light that should be going to your eyes.

Take a look through a pair of binoculars not adjusted for your eyes, then look through a pair that is adjusted properly. Notice the difference. If possible, always use the same binoculars.

Most glasses are treated scientifically to reduce glare, but there are times when the direct rays of the sun are so strong that it is almost impossible to distinguish shapes and colors. To overcome this handicap, glasses usually have colored lens filters that can be inserted over the regular lenses, reducing glare considerably.

CARE OF OPTICS

Optical instruments require great skill and precision in their manufacture. They are both delicate and expensive. As with all precision equipment, careless handling can render them out of adjustment or useless. All maintenance should be accomplished according to current MRCs.

Your optics have many enemies. The major ones are dust, heat, light, and moisture. A severe shock, such as falling to the deck, may cause breakage either of lenses and prisms or mechanical parts. A sharp shock invariably causes the prisms and reticles to become misaligned.

Prevent dust from getting on the lenses as much as possible. Always leave the optics in their cases, or covered, when not in use. When dust gathers on the lenses, clean them only with lens paper, and make sure that your supply of lens paper is kept clean. Don't clean a lens when it doesn't need it. Repeatedly cleaning a lens, no matter how skillfully you do it, eventually damages the lens. Strong sunlight discolors the cement, and excessive heat often softens cemented lenses and filters and may allow them to separate. Moisture in any form, whether salt spray or the perspiration from your hand, causes film and chemical deterioration of the optical glass.

To have a useful piece of optical equipment when you need it, follow these few simple rules:

- Handle your optical equipment carefully. Don't let it bang against another object.
- When the optical equipment is not in use, keep it stowed in its proper place.
- Keep it dry and out of the weather.
- Keep it clean; use only appropriate material to clean it.
- Don't hang optical devices over the side, and when you are using binoculars, always keep them on a strap around your neck.
- Don't attempt to repair optical equipment. Send it to a repair ship or tender where Opticalmen have the proper equipment to make repairs.

NIGHT VISION DEVICES

LEARNING OBJECTIVE: Explain procedures for operating, maintaining, and cleaning night vision devices.

Night vision devices belong to a family of precision instruments that use electronic optics for observation, surveillance, and navigation. Night vision sights (NVSs) can be used in conjunction with the IR equipment discussed previously in this chapter.

Night vision devices are used to scan an area accurately and to detect enemy movement, to observe friendly forces, or to accomplish various other tasks associated with night devices.

Normally, night vision devices will be operated on ships from the signal bridge and bridge level. As a Signaller, you will be required to maintain and operate night vision equipment.

This section will acquaint you with the principles of operation, maintenance, and safety precautions for night vision devices.

MK 37 NIGHT VISION SIGHT

The Mk 37 Mod 1 and Mod 3 NVS (fig. 2-16) are passive sights that emit no visible or IR light. An image intensifier tube is used to amplify received light, thus enhancing or allowing vision under nighttime or similar conditions of low illumination. The primary function of the Mk 37 NVS is long-range observation, such as enemy surveillance and target detection.

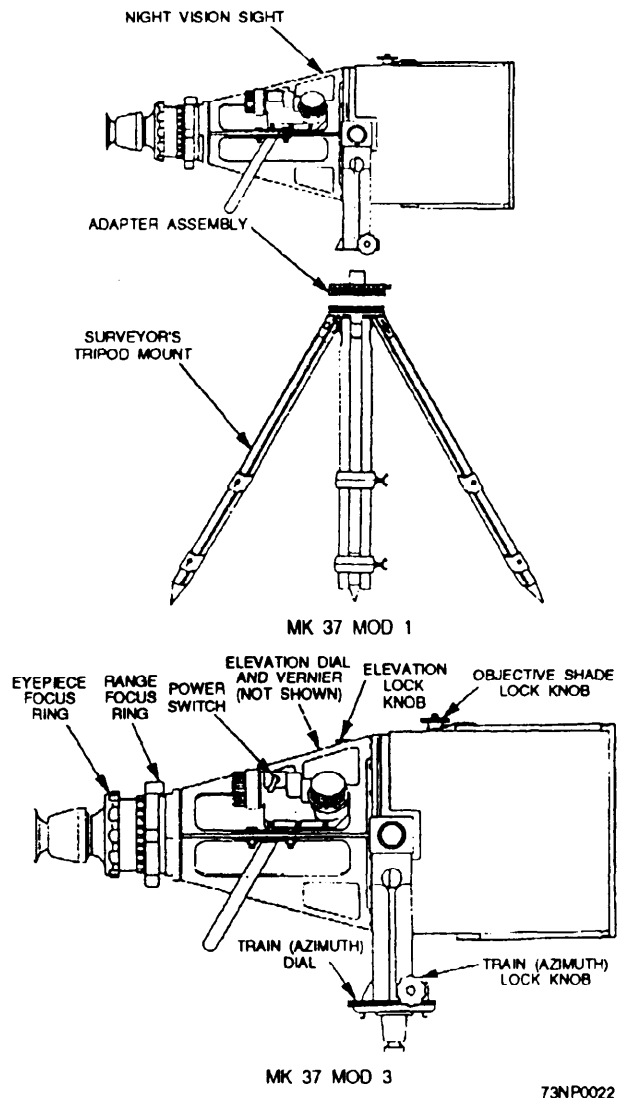

Figure 2-16.—Mk 37 Mod 1 and Mod 3 night vision sights.

The two models of the Mk 37 NVS differ basically by the type of mount used. Mod 1 is mounted on a tripod, and Mod 3 is bracket-mounted on the ship's signal bridge railing. The tripod mount supplied with the Mod 1 consists of three adjustable legs with a tripod adapter on top to secure the sight to the mount. The bracket mount for the Mod 3 is approximately 6 inches by 4 inches by 3.5 inches and is used when installing the sight at a suitable viewing location. The bracket mount is capable of positioning the Mk 37 Mod 3 through 360 degrees in train and from -28 degrees to +44 degrees in elevation.

The Mk 37 consists of three functional sections: objective lens, image intensification tube, and eyepiece.

The objective lens assembly consists of lens elements and mirrors, which function optically together and focus the image. The assembly is purged and sealed in an atmosphere of dry nitrogen to prevent lens fogging.

The image intensification tube consists of three stages of fiber optics, each with a photocathode and phosphor screen amplifying and transferring the image to the next stage. The adjustment for the intensifier is set at installation to prevent damage to the intensifier tube and must not be disturbed.

The eyepiece assembly consists of glass elements that function to magnify and focus the image on the eye of the operator. The Mk 37 NVS has seven glass elements in each eyepiece. The eyepiece assembly is purged and sealed in an atmosphere of dry nitrogen to prevent fogging. The Mk 37 NVS is supplied with a monocular eyepiece; attached to the eyepiece is a rubber eyeshield, which protects the eyes and aids in security by covering the areas around the eye. Light leaks are thereby prevented. In addition to the monocular eyepiece lens, the Mk 37 NVS is supplied with a binocular eyepiece lens. This lens allows the observer to use both eyes, thereby reducing eye fatigue. The binocular eyepiece allows a small amount of backglow from the image tube to illuminate the operator but is acceptable for most surface-ship applications.

A power converter is supplied with the NVS for convenience in use aboard ship or whenever 115-Vac, 60-Hz power is available. The power converter consists of the converter unit and cord assembly. It is sealed in a plastic cylindrical case in a threaded metal cap and is not repairable. The input connector of the converter is on the cap end, and the output spring contact is on the other end. The converter unit screws into the battery case of the NVS after the battery has

been removed. The 20-foot cord has a converter plug on one end and a standard shipboard 115-Vac, 60hz power plug on the other. If the entire cord is not required to reach the power source, roll up the excess to avoid creating a walking hazard. A BA 1100/U 6.8-volt disposable mercury battery is also supplied with the NVS. The battery has a 72-hour continuous-use life-span and a 2-year shelf life. The battery is placed in the main housing with the positive end first. The positive end is easily identified, even in the dark, by its slightly raised center.

Operation

Before operating the Mk 37 NVS, the operator needs knowledge and skill in the installation and setting up of the equipment. Actions required prior to installation are as follows:

1. Relieve air pressure inside the carrying case by pressing the core of the relief valve, located near the carrying handle, before releasing the latches.
2. Cut wire seals by all case latches.
3. Release all case latches and remove the cover.
4. Inventory and inspect the contents to ensure they are ready for installation.

Installation of the NVS consists of mounting the sight on the appropriate operational location and installing the power converter or battery. Locate the NVS at two positions, one port and one starboard. Ensure 360-degree rotation and that the location provides ample clearance for operation of the sight in all positions of train and elevation without interference.

The setup consists of removing the NVS from the storage case. Secure the pintle in the bracket and locking assembly. If the sight is to be battery operated, insert the battery and replace the battery cap. If the power converter is to be used, store the battery cap in the case and insert the power converter in the battery housing; rotate it clockwise until it is secure. Connect the cord between the converter and a 115-Vac, 60-Hz power source. The sight is now ready for operation.

CAUTION

- Do not leave the battery in the equipment during storage, or corrosive damage may result.
- Do not remove the cover in daylight.

The following steps are required to place the M 37 NVS in operation:

1. Place the power switch in the ON position.
2. Press your eye against the monocular lens eyeshield flap and view the image, or view the image with both eyes through the binocular eyepiece.
3. Adjust the diopter ring to create a sharp reticle image.
4. Adjust the focus ring for a clear image of the object desired.

AN/PVS-8

The AN/PVS-8 (fig. 2-17) is a portable, shipboard-mounted, battery-operated NVS used for long-range surveillance. The unit uses the mounting system common to the Mk 37 NVS. An eye shield is used to prevent the visible light emitted from the eyepiece from being externally visible on the operator's face. Power is provided by two 1.5V AA batteries with a life of 60 hours. Magnification of the unit is 6.2X with a 4.7-degree field of view. As with other NVSs, an internal image intensifier tube amplifies available light such as moonlight, starlight, and skyglow, so the scene becomes visible to the operator. An automatic brightness control is provided to automatically maintain the viewed scene illumination contrast during periods of changing light level conditions. The manual gain control (tube brightness) will not function when the automatic brightness control is in operation. The image

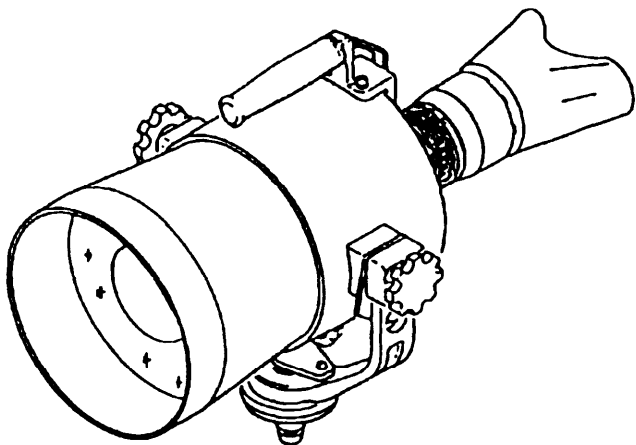

Figure 2-17.—AN/PVS-8 long range night vision sight.

intensifier tube also has protection from high-intensity, short-duration flashes of light.

OPERATION

Setup and operation of the AN/PVS-8 is similar to the Mk 37; actions required prior to installation are as follows:

1. Relieve air pressure inside the carrying case by pressing the core of the relief valve, before releasing the latches.
2. Release all case latches and remove the cover.
3. Inventory and inspect the contents to ensure they are ready for installation.

Setup of the NVS consists of mounting the sight on the appropriate operational location and installing the batteries. Remove the NVS from the storage case. Secure the pintle in the bracket and locking assembly. Rotate the TUBE BRIGHTNESS control switch fully counterclockwise to the OFF position. Insert the batteries and replace the battery cap. The sight is now ready for operation.

CAUTION

- Do not leave the batteries in the equipment during storage, or corrosive damage may result.
- Do not remove the cover in daylight.

The following steps are required to place the AN/PVS in operation:

1. Rotate the TUBE BRIGHTNESS control clockwise to turn on the NVS.
2. Press your face against the eyeguard and view the image.
3. Adjust the TUBE BRIGHTNESS control to the setting that provides good target to background contrast.
4. Adjust the range focus ring for a clear image of the object desired.

Now that you have the sights operational, you must learn scanning procedures. A well-trained operator will see more than an inexperienced one. Targets that are readily identifiable by a trained observer will invariably escape detection by the

untrained eye. You must learn to scan through practice. Detailed information to help develop scanning skills is given in *Basic Military Requirements*.

Maintenance

To make sure the sights are always ready for operation, organizational maintenance personnel must perform a systematic inspection to discover and correct defects before they result in equipment failure. Scheduled maintenance is to be performed as described on current MRCs. If any part is defective or missing, other than those authorized for replacement or repair, requisition a replacement sight according to normal supply procedures.

NIGHT VISION GOGGLES

Night vision goggles, AN/PVS 5A, 5B, and 5C (fig. 2-18) provide improved night vision, using available light from the night sky. An auxiliary IR light source provides illumination for close-up work when ambient light is low. The goggles enable the user to observe from the air, as well as perform normal ground tasks such as reading, walking, and driving.

The goggles are binoculars consisting of two identical monocular eyepieces mounted on an adjustable frame and may be moved sideways. Each monocular assembly consists of three primary subassemblies: objective lens assembly, image intensifier, and eyepiece lens assembly. The goggles are mounted in a cushioned face assembly, which is strapped on to the user. The goggles are approximately 5 inches high, 7 inches wide, 6 inches deep, and weigh 32 ounces without carrying case.

The mechanical function of the goggles is to accommodate differences in the physical characteristics of individual users. This is done by adjusting the IPD, diopter setting, focus, and eye relief.

The two monocular assemblies are mounted in the frame and may be moved laterally to coincide with individual user's IPD. Lateral movement is performed by loosening the lever clamp, which releases tension from the guide assembly and permits each monocular eyepiece to slide on flanges of the tube housing. Each monocular eyepiece is moved manually to the desired IPD, and the lever clamp is tightened.

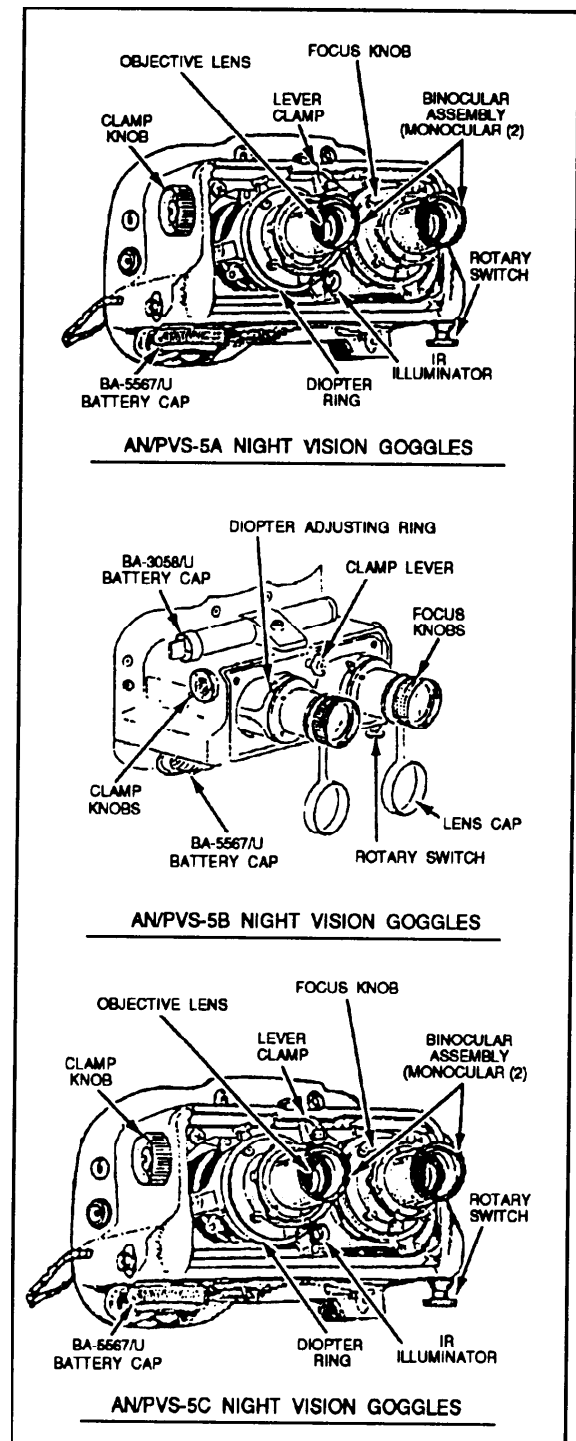

73NP0024

Figure 2-18.—AN/PVS 5A, 5B, and 5C night vision goggles.

To adjust the diopter setting, adjust each eyepiece by rotating the diopter adjust ring, which moves the eyepiece assembly nearer to or further from the user's

eye. Each eyepiece is adjustable through a range of +2 to -6.

Each objective lens assembly is focused by rotating the focus knob. The objective lens is screwed into the mounting collar and the knob is attached to the lens and held in place by the focus knob retainer. Rotating the focus knob positions the objective lens for viewing at desired ranges.

The eye relief adjustment allows the binocular assembly to be moved within the frame for eye relief and comfort. Clamp knobs, located on either side, can be loosened by turning the knobs counterclockwise and manually moving the frame to reposition the binocular assembly with reference to the user's eyes. The assembly is tightened into place by turning the clamp knob clockwise.

Operation

The principles of operation are the same for the AN/PVS 5A, 5B, and 5C. The operating phase of night vision goggles consists of pre-operation, test operation, and post-operation instructions.

Pre-operation instructions:

1. Release the air pressure as instructed on the side of the storage case.
2. Release the latches and open the storage case and remove the goggles. Inspect the goggles for damage.
3. Ensure the rotary switch is in the OFF position.
4. Use only one battery compartment at a time. Insert battery/batteries (AN/PVS 5A uses only one lithium battery; the AN/PVS 5B and 5C use either one lithium battery or two alkaline batteries in one compartment) and replace the cap.
5. Snap the headstrap to the face mask, making sure all straps are extended to their maximum lengths. Place the head strap on your head, grasp the straps with both hands and slowly pull until the face mask cushion touches your face. Continue pulling until the goggles feel snug. Perform the same step for the vertical head strap.
6. Remove the objective and eyepiece lens caps. If demisting shields are used, snap them over the eyepiece lens. Be careful not to smudge the eyepiece lens or demisting shield.

7. Loosen the lever clamp and adjust the monoculars for proper distance between your eyes. Tighten the clamps.

8. Loosen the clamp knob and adjust the binocular assembly until the eyepieces are located a comfortable distance from your eyes with proper tilt. Tighten both clamps.

Instructions for test operation:

1. Position the rotary switch to the ON position.
2. Loosen the lever clamp and adjust the goggles for proper spacing between the monocular eyepieces. Retighten the clamp.
3. Loosen both clamp knobs and adjust the goggles for proper tilt and eye relief. Retighten the clamp knobs.
4. On the AN/PVS 5A and 5B, turn the focus knob fully counterclockwise on each objective lens for distant viewing. Adjust for the clearest view. The focus knob may be turned fully clockwise to adjust for a minimum focus of 10 inches. On the AN/PVS 5C goggles, the focus function is part of the objective lens assembly. To focus the goggles for the sharpest view, grasp the outside of each objective lens assembly and turn it to obtain the sharpest image.

5. Adjust each diopter ring until the image is sharp (the diopter ring adjusts the diopter for each individual user and does not require movement after initially set).

6. Pull and turn the rotary switch for IR operation (optional test). Return the switch to ON for normal operation. The rotary switch turns the goggles and IR illuminator on and off. Be sure it is turned to OFF when the goggles are not in use.

Post-operation instruction:

1. Remove the demisting shields, if installed, by grasping them and pulling them off the eyepiece lenses. Return them to their case.
2. Replace the objective and the eyepiece lens cap.
3. Ensure the rotary switch is in its OFF position. Remove the battery (or batteries) from the battery compartment(s) and return it to its case. Replace the battery caps.
4. Inspect the face mask cushion for tears, cracks, or missing snaps; also inspect the goggles for missing parts.
5. Clean the goggles, carrying case, and shipping case as necessary with fresh water. Ensure both cases and liner are dry prior to storing the goggles in them.

6. Loosen the clamp knobs and the lever clamp.

7. Store the goggles, batteries, and accessories in the cases, making sure they are properly positioned to close, and then latch the carrying case.

8. Store the carrying case in the storage case if the goggles are to be placed in prolonged storage. Latch the storage case.

AN/PVS-11 Pocketscope

The pocketscope (fig. 2-19) is a hand-held, submersible NVS equipped with either a 1X or 3X magnification lens used for short-range observation in either passive or active mode. The power source is two 1.5V AA batteries with a life of 40 hours. This NVS is provided with an IR source for close-up viewing. It can illuminate a man-size target at 15 meters in active mode. The unit also has an optional adapter for a 35mm camera or closed circuit television.

OPERATION

This NVS is similar in operation to other NVSs used by the Navy. The same precautions should be exercised with it as with the others. For passive operation, set the OFF-ON-PULL IR switch to on and observe that a green glow is visible in the eyepiece. Adjust the eyepiece and objective lens for proper focus. The pocketscope is ready for passive night vision operation. For IR illuminator mode (active), pull out the OFF-ON-PULL IR switch and rotate it to the PULL-IR position. Observe that the area in the immediate front of the pocketscope is illuminated.

CAUTION

The IR source is a light that is invisible to the unaided eye. However, the light from the illuminator can be detected by opposing forces using NVSs.

Maintenance

Routine maintenance for night vision goggles and the pocketscope is basically the same as for the Mk 37 and AN/PVS-8. Scheduled maintenance is to be performed as described on current MRCs to discover and correct any defects before they result in operational failure. If any part is defective or missing, other than the parts authorized for replacement or repair at the organization level, requisition

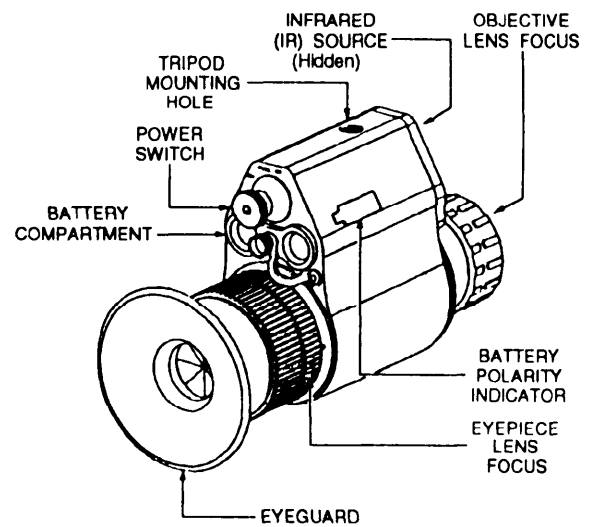

73NP0025

Figure 2-19.—AN/PVS-11A pocketscope.

replacement units. Review the technical manual before performing any maintenance on night vision devices.

GENERAL SAFETY PRECAUTIONS

Night vision devices are precision electro-optical instruments and must be handled carefully at all times.

The image intensifier assembly phosphor screen contains toxic material. If an assembly becomes broken, be extremely careful to avoid inhalation of the phosphor screen material, and do NOT allow it to come in contact with the mouth or open skin wounds. If the phosphor screen material comes into contact with the skin, wash immediately with soap and water. If phosphor screen material is swallowed or inhaled, induce vomiting and seek medical help.

The batteries used in NVSs require special handling to avoid possible physical harm or equipment damage. Return all used or damaged batteries to the property disposal officer. The following are the batteries used in NVS:

1. BA 1567/U battery.
2. Alkaline Battery BA 3058/U.
3. Lithium Battery BA 5567/U. This battery contains sulfur dioxide gas under pressure. Do not heat, puncture, disassemble, or otherwise tamper with the battery. Turn off the equipment if the battery compartment becomes too hot; wait until batteries have cooled before removing them. Batteries have a safety vent to prevent explosion. When they are venting gas, you will smell gas, your eyes may become irritated, or

you may hear the sound of gas escaping. When safety vents have operated, batteries must still be handled with care.

Do not remove any covers during daylight. During nighttime operation do not leave sights pointed at a bright light for extended periods of time, because the image intensifier tube may be permanently damaged.

Before using any NVSs, you must review the technical manual.

FLAGS AND HALYARDS

LEARNING OBJECTIVE: Identify the procedures for the proper care and repair of flags, for going aloft, and for splicing and reeving halyards.

Working with flags is an integral part of the Signalman's job. Flags are used to send messages and tactical signals during daylight, to identify a ship's nationality, and, on occasion, to indicate the seniority of an officer or civil official on board. Individual flags are discussed in other chapters. This section is confined to describing flags and halyards in general.

Bunting, the cloth of which flags are made, is available in cotton, wool, and nylon. Because cotton costs less, it is usually used in simply designed flags and pennants. Cotton bunting is not as durable as wool and will not stand as much weathering, but it is often less expensive to wear out two cotton flags than one woolen flag. Flags and pennants that are in almost constant use, however, usually are made of wool or nylon. Wool is also used in flags of complicated design when the original cost of material is less important than the labor involved.

FLAG NOMENCLATURE

The parts of flags and pennants are shown in figure 2-20. The fly is the horizontal length of the flag, the hoist is the vertical width. Tabling is a reinforced border of light duck, stitched to the edge of the flag at the hoist. A length of line leads through the tabling, at the top of which a ring is spliced. The other end of the line, extending several inches below the tabling, is the tail line. A snap hook is attached to it. The tail line serves as a spacer between flags, and the snap and ring are used to secure flags to each other in a hoist.

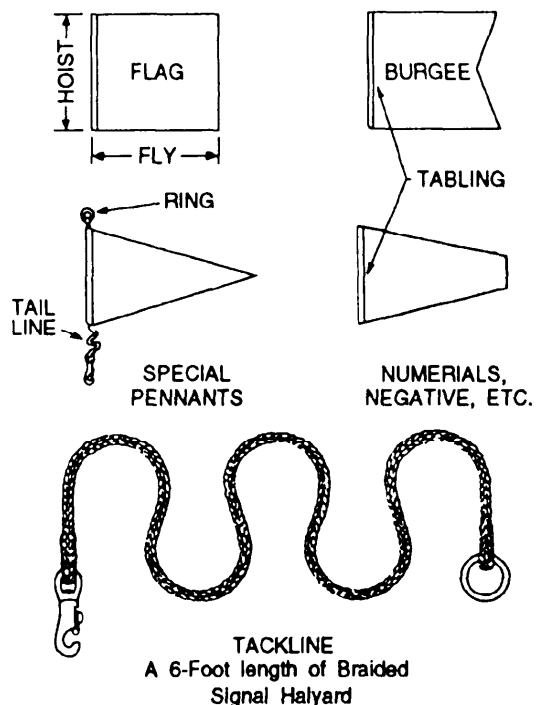

73NP0026

Figure 2-20.—Parts of flags and pennants.

CARE OF FLAGS

Wind and moisture cause flags to deteriorate rapidly. Unless stowed promptly and handled carefully, flags quickly become dirty. The flagbag (fig. 2-21) is designed to provide proper stowage for the

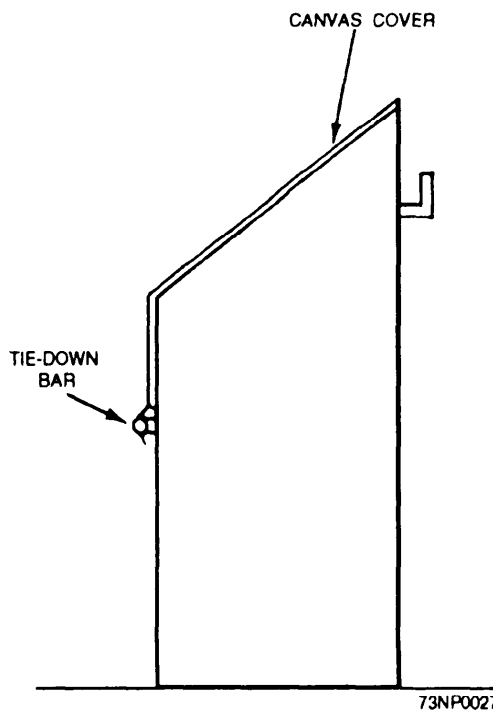

73NP0027

Figure 2-21.—Flagbag.

flags and rapid access to them. It also keeps them clean and, with the canvas cover in place during inclement weather, dry. Flags should be washed in the ship's laundry periodically. Only mild soap and warm water (not hot) should be used for cleaning flags. Grease spots can be removed with dry-cleaning solvents.

Damp or wet flags are mildew prone. When flags are wet, dry them as soon as possible by hoisting them on the signal halyards. This should not be done when under way or when in high winds. Air bunting is an excellent way to dry flags. This can be done on request from the senior officer present.

REPAIR OF FLAGS

Although ships carry spare sets of flags, Signalman strikers or third class petty officers may be assigned to repair bunting. If a bunting space is available, it will contain a sewing machine, bunting, thread, tapes, and tabling material. If a bunting repair space is not available, repairs may be done by using a sewing machine located in the deck spaces. When repairing flags, never mix materials. Wool and cotton shrink differently, and combinations invariably become misshapen after the first wetting. For correct dimensions, refer to NTP 13, *Flags, Pennants and Customs*.

HALYARDS

Signal halyards are made of either nylon or natural color braided cotton line. The braided cotton line is no longer used aboard ship, because it could not hold up under the effects of ships' high speeds, stack temperatures, and gases. Ashore, however, cotton halyards are still used. Double-braided 1 1/8-inch nylon rope is required by the Board of Inspection and Survey (INSURV). Double-braided 1 1/2-inch nylon rope is permitted alternately with twisted rope for dressing lines. The twisted nylon and double-braided nylon rope withstand the heat and gases much better than braided cotton line.

Halyard blocks are single, roller-bushed sheave blocks. They are attached by means of sister hooks to U-bolts welded to the yardarms. Those attached to stays and mastheads may be of other construction, adapted to the construction of the stay or masthead.

CARE OF HALYARDS

When reeving halyards through signal halyard blocks, always reeve forward to aft. Rings and snaps on halyards are put on with a halyard eye splice.

Splicing double-braided nylon rope is explained and illustrated in the following section.

At night and during inclement weather, ease off the halyards to prevent unnecessary strain caused by shrinkage. At other times, however, keep halyards clear and taut to give the signal bridge a sharp appearance. Periodically check the condition of the halyards. Replace them before they become too worn.

SPLICING DOUBLE-BRAIDED LINE

When double-braided nylon line is being spliced, the end must be worked into the center, and special tools are needed for the job. For line 3 inches in circumference or smaller, a fid and pusher are used. For line larger than 3 inches in circumference, only a wire fid is used. Steps 1, 2, and 3 in figure 2-22 show how to secure the fid to the line. Stamped on each fid is a number indicating the size of line for which the fid was made. Fids also serve as rulers to measure with while splicing is being done. The wire fid lengths in figure 2-23 are in 1/2 and 1/3 scale. Friction or masking tape and a soft lead pencil, crayon, or preferably, a wax marking pencil are needed. Sharp-pointed shears also are handy.

The splice described here, and the line on which it is used, were developed by the Samson Cordage Works of Boston, Massachusetts.

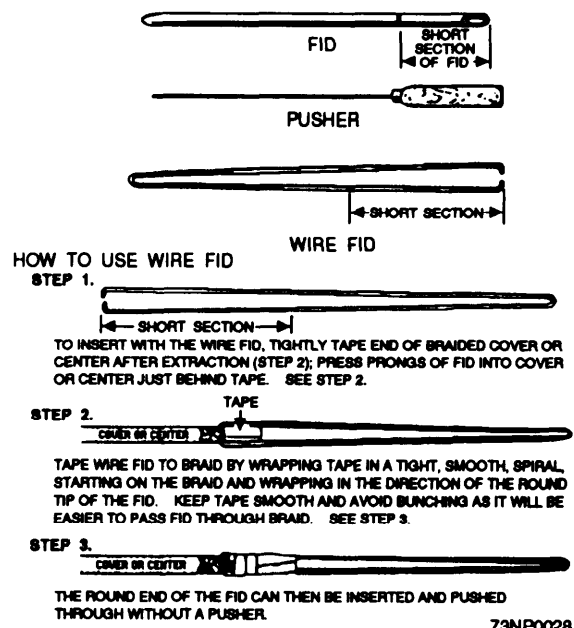
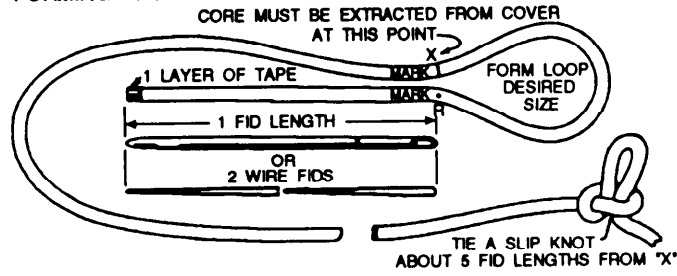
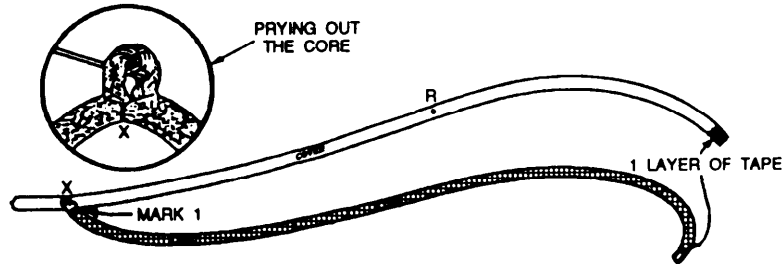

Figure 2-22.—Fids used for splicing double-braided line.

STEP 1. FORMING THE LOOP



STEP 2. EXTRACTING THE CORE



STEP 3. MEASURING

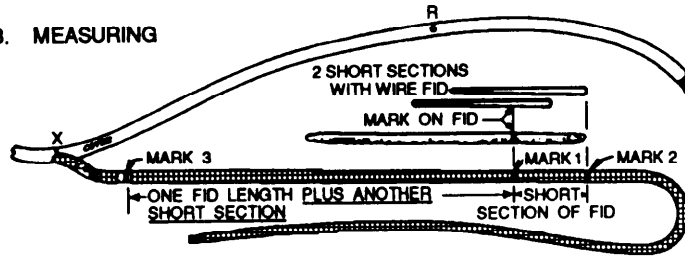

STEP 4. MARKING THE COVER FOR TAPERING

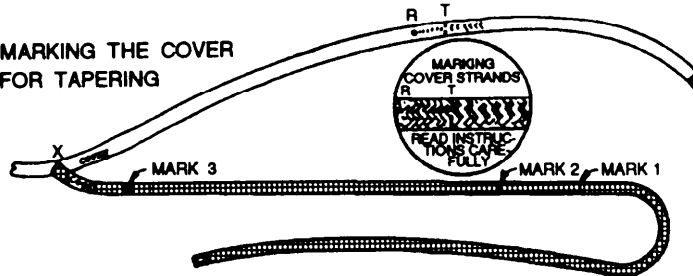

STEP 5. TAPERING

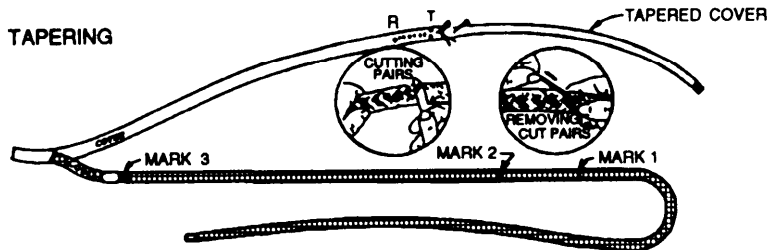

73NP0029

Figure 2-23.—Measuring and taping.

Standard Eye Splice in New Double-Braided Line

The standard eye splice can be performed on new line only. It retains up to 90 percent of the average new line strength. Until you become

familiar with splicing this material, follow each step in detail. Figure 2-22 shows the fids and pushers used for splicing; steps 1 through 3 explain how to secure the wire fid to the line that is to be spliced. Figure 2-23 shows how to mark the line and extract the core.

1. Tape the end to be spliced with one thin layer of tape. Then, measure one tubular fid length (two wire fid lengths, because the wire fid is 1/2 size) from the end of the line and mark. (This is point *R* (reference), step 1 of fig. 2-24.) From *R*, form a loop the size of the eye desired and mark. (This is point *X*, where you extract the core from inside the cover.)

2. Tie a tight slipknot approximately five fid lengths from *X*. This must be done to keep the core and cover from becoming uneven. Bend the line sharply at *X*. With the pusher or any sharp tool, such as a ice pick, awl, or marlinespike, spread the cover strands to expose the core (step 2 of fig. 2-24). First pry, then pull the core completely out of the cover from *X* to the taped end of the core. DO NOT pull cover strands away from the line when you are spreading the cover, as this will distort the line unnecessarily. To assure correct positioning of mark 1, do the following: holding the exposed core, slide the cover as far back toward the tightly tied slipknot as you can. Then, firmly smooth the cover back from the slipknot toward the taped end. Smooth again until all cover slack is removed. Then, mark the core where it comes out of the cover. (This is mark 1.)

3. Again slide the cover toward the slipknot to expose more core. From mark 1, measure along the core toward *X* a distance equal to the short section of tubular fid (two short sections with wire fid) and make two heavy marks. (This is mark 2.) From mark 2, measure in the same direction one fid length plus another short section of the fid (with wire fid, double measurements) and make three heavy marks. (This is mark 3, step 3 of fig. 2-24.)

4. Note the nature of the cover braid—it is made up of strands, either one or two (pair). Notice that half the pairs revolve to the right around the rope and half revolve to the left. Beginning at *R* and working toward the taped end of the cover, count eight consecutive strands (single or pairs) that revolve to the right (or left). Mark the eighth strand. (This is mark *T*, step 4 of fig. 2-24.) Make mark *T* go completely around the cover. Starting at *T* and working around the taped cover end, count and mark every fifth right and left strand (single or paired) until you have progressed down to the end of the taped cover.

5. Insert the fid into the core at mark 2. Slide it through and out at mark 3. (Step 5 of fig. 2-24.) Add extra tape to the tapered covered end, then jam it tightly into the hollow end of the fid (see insert). Hold the core lightly at mark 3; place the pusher point into the taped end; push the fid and cover through from mark 2 and out at mark 3. With the wire fid, first press prongs into

the cover, then tape over. Then after the fid is on, milk the braid over the fid while pulling the fid through from mark 2 to mark 3. Take the fid off the cover. Continue pulling the cover tail through the core until mark *R* on the cover emerges from mark 3 (see step 6 of fig. 2-24). Then remove the tape from the end of the taped cover.

6. Make sure the tape is removed from the cover end. Start with the last marked pair of cover strands toward the end; cut and pull them out completely (see step 7 of fig. 2-24). Cut and remove the next marked strands and continue with each right and left mark strand until you reach point *T*; do NOT cut beyond this point. The result should be a gradual taper ending in a point. Very carefully pull the cover back through the core until point *T* emerges from mark 2 of the core (see step 8 of fig. 2-24). From point *X* on the cover, measure approximately one-half fid length toward the slipknot on the line and mark this point *Z* (see step 9 of fig. 2-24).

7. You are now ready to put the core back into the cover from *T* to *Z*. Insert your fid at *T* (step 9 of fig. 2-24). jam the taped core end tightly into the end of the fid. With the pusher, push the fid and core through the cover "tunnel," past point *X*, to, and through the cover at point *Z*. When using the wire fid, attach the fid to the tapered core. After the fid is on, milk the braid over the fid while pulling through from *T* to *Z*. When pushing the fid past *X* to *Z*, make sure the fid does not catch any internal core strands.

NOTE

Depending on eye size, the fid may not be long enough to reach from *T* to *Z* in one pass. If not, bring the fid out through the cover, pull the core through, and reinsert the fid into the same hole it came out of. Do this as many times as needed to reach point *Z*.

8. Alternately pull on the core tail at *Z*, then pull the tapered cover at mark 3. The crossover should be tightened until the crossover is equal to the diameter of the line. Remove all the slack from the eye area by smoothing the cover from point *T* toward *X*. Mark where the core tail emerges through the cover at point *X* (see step 10 of fig. 2-24). Pull the core tail out until the mark just made on the core is exposed at *Z*. The diameter of the core must now be reduced by cutting and removing one strand of each group around the complete circumference. Measure one-third fid length from the first reduction cut toward the end and make a mark. Cut

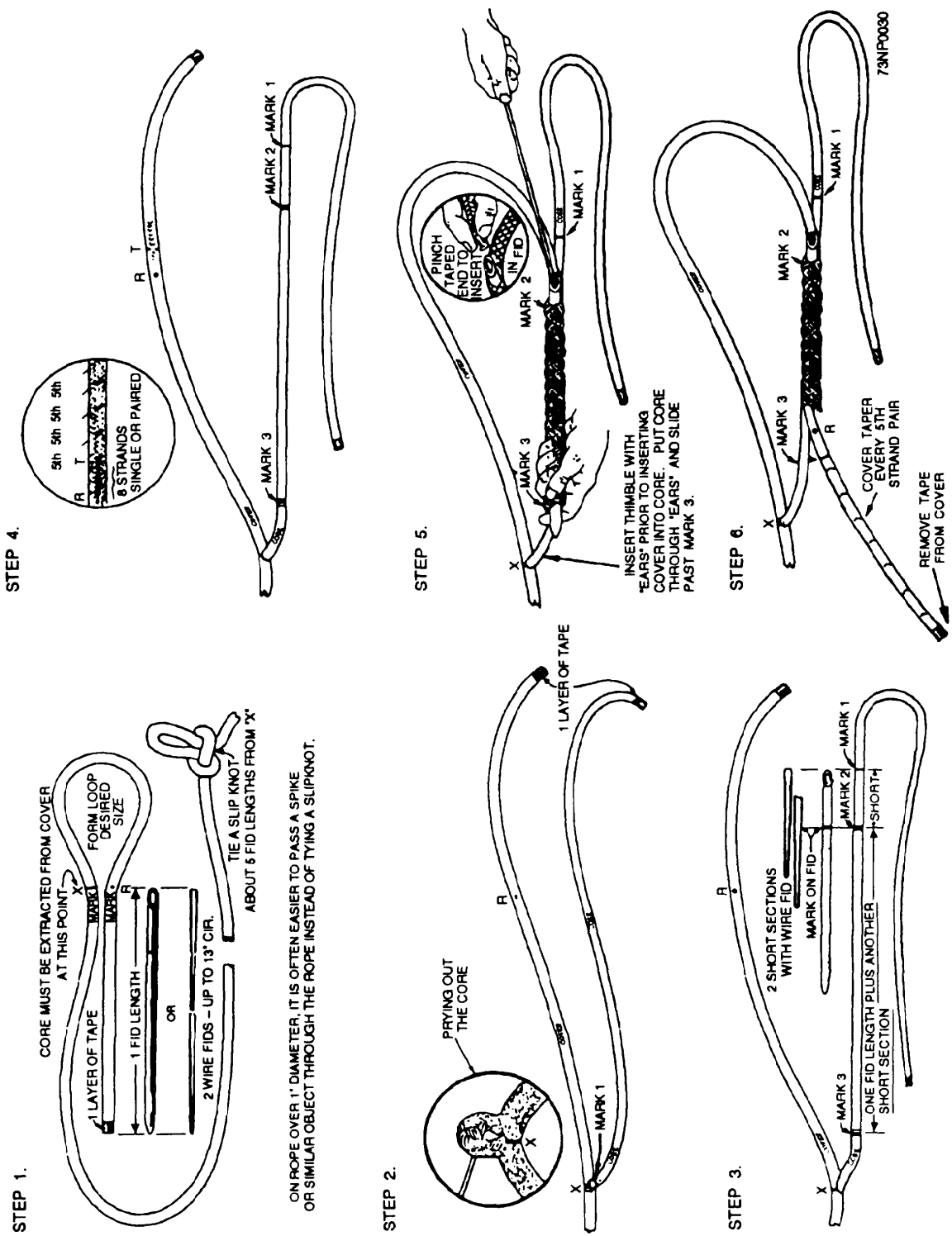

Figure 2-24.—Completing the double-brained eye splice (page 1 of 2).

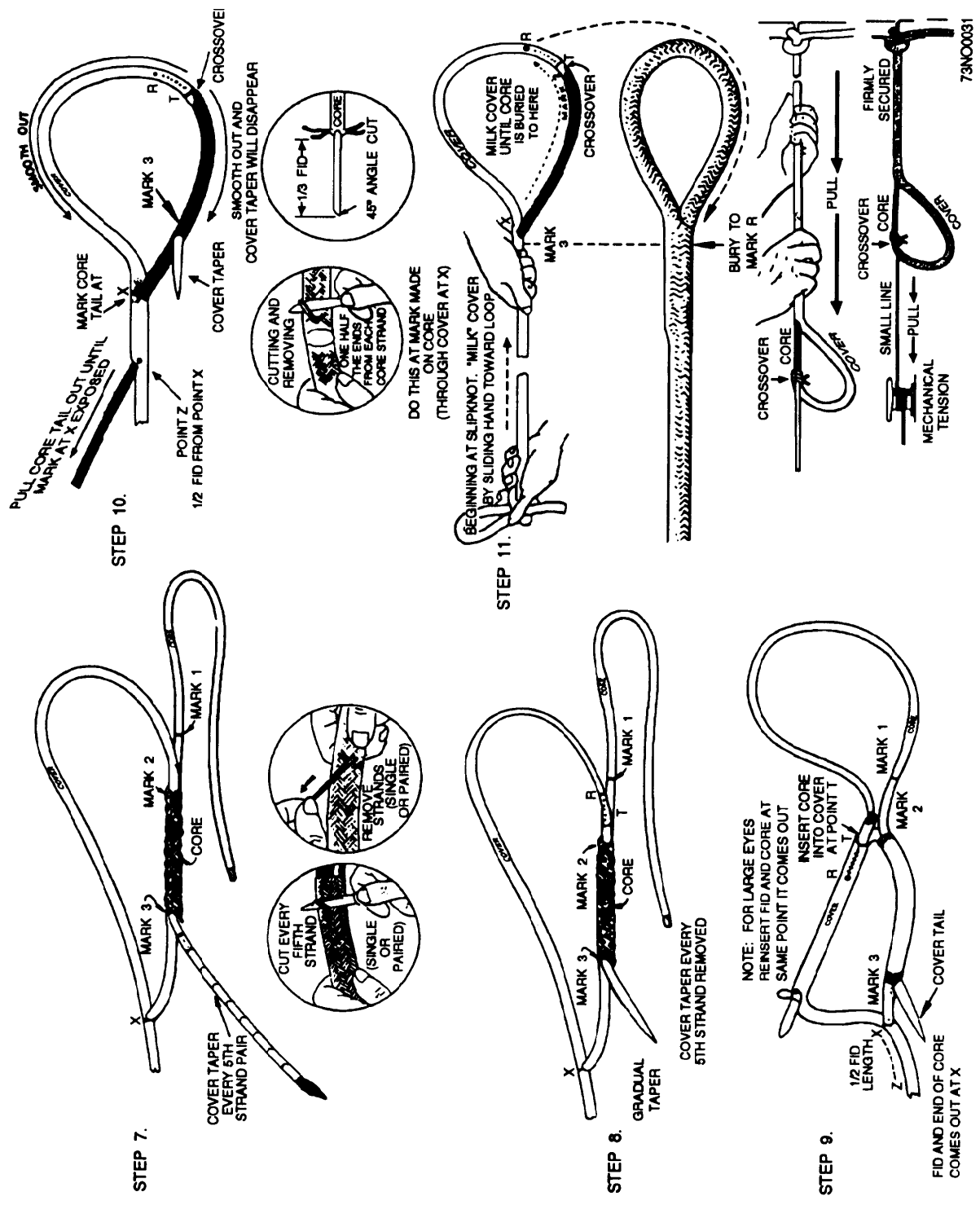

Figure 2-24.—Completing the double-braided eye splice (page 2 Of 2).

off the remaining tail at this point. Make the cut on a 45-degree angle to prevent a blunt end (see the insert of step 10). With one hand, hold the crossover part (mark *T*). Smooth the cover section of the eye out firmly and completely from the crossover toward mark *X*. The reduced-volume core tail should disappear into the cover at 2. Smooth out the core section from the crossover toward mark 3, and the cover taper will disappear into the core. Hold the rope at the slipknot, and with your other hand milk the cover toward the splice, gently at first, then more firmly (see step 11 of fig. 2-24). The cover will slide over mark 3, mark 2, the crossover, *T*, and *R*. (It may be necessary to occasionally smooth out the eye during milking to prevent the reduced-volume tail from catching in the throat of the splice.)

If bunching occurs at the crossover, preventing full burying, smooth the cover from *T* to *X*. Grasp the crossover at *T* with one hand, and then firmly smooth the cover slack (female side of eye) with the other hand towards the throat (*X*). Repeat as necessary until bunching disappears. Continue milking until all of the cover slack between the knot and the throat of the eye has been removed.

NOTE

Before burying the cover under the crossover, you should do the following:

- Anchor the loop of the slipknot to a stationary object before starting to bury the cover. You can then use both hands and the weight of your body to more easily bury the cover over the core and crossover.
- Holding the crossover tightly, milk all excess cover from *R* to *X*.

Flex and loosen the line at the crossover point during the final burying process. Hammering the cover at point *X* will help loosen the strands.

With larger ropes, it is helpful to securely anchor the slipknot; attach a small line to the braided core at the crossover; and mechanically apply tension with either a block and tackle, capstan, come-a-long, or power winch. Tension will reduce the diameter of the core and crossover for easier burying.

9. Prior to whipping (see fig. 2-25), it is to your advantage to stitch-lock the splice to prevent no-load opening. You will need approximately one fid length of nylon or polyester whipping twine. The twine should be about the same size as the strands of line you are stitching. Strands cut from the line may be used. To begin the lock stitch, pass the twine (*A*) through the line as shown in step 1, figure 2-25. Reinsert the twine as in step 2, figure 2-25. (Ensure that all stitching is just snug. **DO NOT TIGHTEN.**) Continue until you have four complete stitches. After you have four stitches, turn the line 90 degrees and pass the remaining end (*B*) through the line perpendicular to the original stitches to make four more stitches. The line should now look like step 4, figure 2-25. Now take ends *A* and *B*, tie a square knot, and bury the ends in between the cover and the core. You may now whip the line or leave it.

You will become more proficient at splicing line each time you do it. Remember to follow each step the manufacturer has laid down in the splicing manual. This must be done for safety reasons. The splices described and the methods for accomplishing them have been tried and proven. They leave no margin for shortcuts.

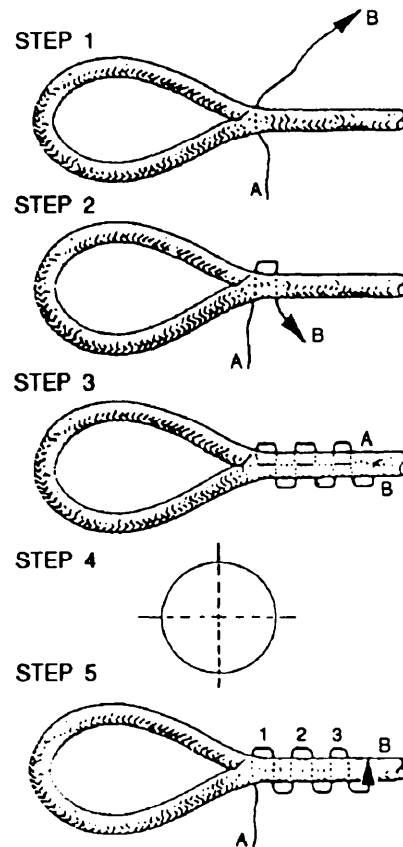

73NP0032

Figure 2-25.—Making the lock stitch.

Eye Splice

To make an eye splice with manila or synthetic ropes, untwist the strands in the end of your line as you think necessary, and splice them into the standing part of the line by tucking the unlaidd strands from the end into the standing part.

Learn to estimate the length of line you need to unlay for your complete splice so you will not finish short or waste a lot of line by cutting it off. An original round of tucks plus three more complete rounds are enough for an ordinary eye splice.

With large lines you must whip the ends of the strands before you start; otherwise, they will unravel and become troublesome. Large lines also must be seized at the point where the unlaying stops, or you will have trouble working them. With any line up to about 2 inches, you can open the strands in the standing part with your fingers. The fid must be used for larger lines.

Your first round of tucks must be taken in proper order to avoid getting fouled up. Separate the strands in the end and hold them as indicated in view 1 in figure 2-26. Always tuck the middle strand (facing

you) first. Be sure to keep the right-hand strand, shown in view 2 of figure 2-26, on the side of the line that is toward you. Tuck that one next, over the strand you just tucked the other one under, and under the strand just below it, shown in view 3 of figure 2-26.

Now turn the whole thing over. In view 4 of figure 2-26 you can see that you now have only one strand from the end left untucked, and only one strand in the standing part that does not already have a strand under it. Do not forget to tuck the last strand from outboard toward you.

The first round of tucks is the key to making perfect eye splices; the rest is easy. Simply tuck each strand from the end over the strand of the standing part that it is now above, and under the next strand below that one, until you tuck each strand twice more beside the original tuck. Three tucks to each strand in all is enough for natural fiber rope. Four or five are needed for synthetic fiber, especially the more slippery nylon.

Going Aloft

Signalmen must be familiar with the procedures for going aloft, if for conducting maintenance, removing Irish pennants, or rigging for full dress ship. Whatever the reason, permission to go aloft must be

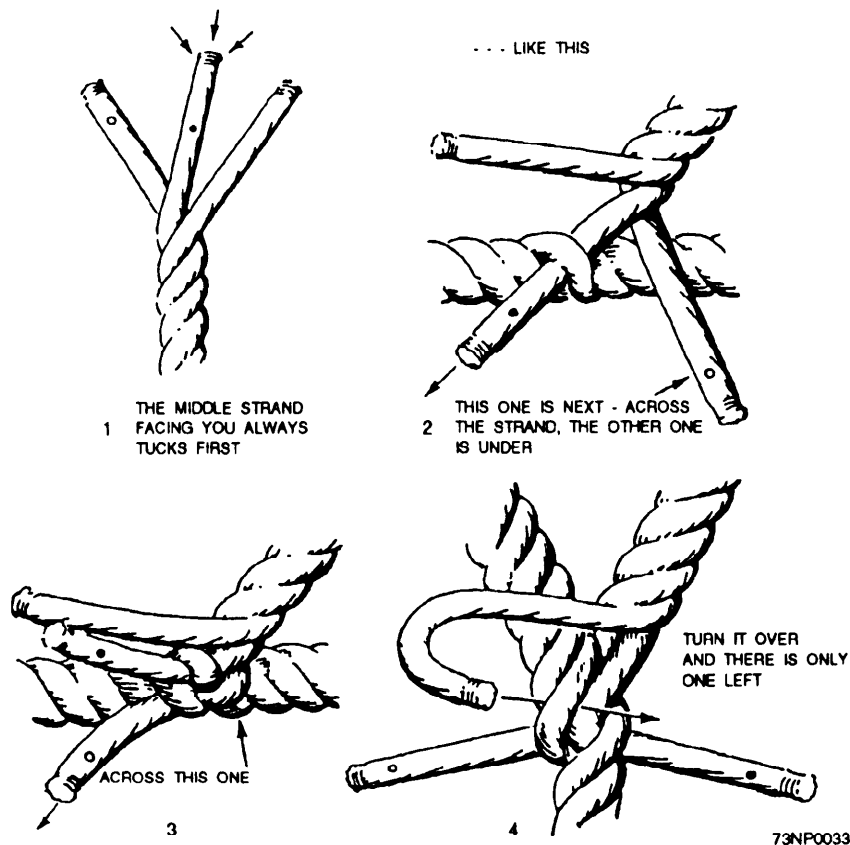

Figure 2-26.—Making an eye splice.

granted by the officer of the deck in port or the commanding officer when under way. Guidance for requesting permission should be included in the signal bridge standing orders.

OPNAVINST 5100.19, *Navy Occupational Safety and Health (NAVOSH) Program Manual*, contains instructions and general precautions for going aloft.

MAINTENANCE AND MATERIAL MANAGEMENT (3-M) SYSTEM

LEARNING OBJECTIVE: Explain the purpose of the 3-M system, the *Hazardous Material Users Guide* and material safety data sheets (MSDS).

Although this chapter points out that Electrician's Mates generally are responsible for electrical repairs of signal equipment, signal bridge personnel do perform routine upkeep and maintenance functions on assigned equipment. Periodic checks and adjustments must be made, for example, and there are stipulated times when equipment should be lubricated for best performance.

To achieve maximum efficiency in the use of material, as well as manpower, the Navy implemented the 3-M system. The basic purpose of the systems is to provide for managing maintenance and maintenance support in a manner that will ensure maximum equipment operational readiness. The 3-M system standardizes preventive maintenance requirements, procedures, and reports on a fleetwide basis.

OPNAVINST 4790.4, *Maintenance and Material Management (3-M) Manual*, is the basic source of information on the 3-M system.

HAZARDOUS MATERIAL USERS GUIDE

The *Hazardous Material Users Guide* was developed to provide Navy personnel, particularly the deckplate sailor, with safety data for hazardous materials commonly used on ships. The Users Guide is written to avoid the need for technical jargon, chemical symbols, or coded information frequently found in material safety data sheets (MSDS).

The Users Guide gives control measures, safety precautions, health hazards, and spill control and disposal guidelines for each of 20 hazardous material

groups (for instance, adhesives, cleaners, greases, paints, and solvents).

The Control Measures section identifies and prescribes personal protective equipment (PPE) that is appropriate for the chemical hazards in a particular group.

The Safety Precautions section gives safety guidance for using and storing hazardous materials in the group.

The Health Hazards section points out common signs and effects of overexposure to the hazardous materials and provides “what to do” instructions to the hazardous materials user.

The Spill Control section provides information for responding to a spill.

The Disposal Guidelines section gives acceptable methods for disposing of materials within the group.

Materials not included in the Users Guide are items such as ammunition, explosives, propellants, medical/pharmaceutical supplies, and radioactive materials.

Material Safety Data Sheets

MSDSs are technical bulletins containing information about materials, such as composition, chemical and physical characteristics, health and safety hazards, and precautions for safe handling and use. MSDSs should be readily available for every item of hazardous material aboard ship.

When performing maintenance and working with hazardous materials, use of the Users Guide and MSDSs is mandatory. Guidelines contained therein are vitally important and **MUST NOT** be ignored. The information will help reduce the risk of injury and long-term health effects.

SUMMARY

In this chapter you were informed of some of the equipment you will come in contact with during your daily routine aboard the signal bridge. This equipment ranges from the 12-inch searchlight to the Mk 37 NVS. You were informed how to operate and maintain this equipment. You were also informed about the care and maintenance of flags, pennants, and halyard line. As you know by now, knowing how to operate signal bridge equipment is a valuable part of being a Signalman. Learn your equipment well!

CHAPTER 3

MESSAGES

A message can be defined simply as a communication sent from one person to another. The Navy defines a message as "Any thought or idea briefly expressed in plain or cryptic language, prepared in a form suitable for transmission by established means of rapid communication." The visual message, with which you are most concerned, is prepared for transmission by means of flashing light, flaghoist, or semaphore. Incidentally, a message that contains the names of signal flags in its text, regardless of the method by which it is transmitted, is a signal.

ORIGINATING MESSAGES

LEARNING OBJECTIVES: Explain the procedure for originating, drafting, and releasing messages. List the types of messages transmitted by communications means.

ORIGINATOR

The originator of a message is the authority in whose name a message is sent, or agency under direct control of the authority approving a message for transmission. The originator is responsible for the function of the drafter and releasing officer. Other responsibilities of the originator include determining whether the message is necessary (a message is not to be used when a letter or other form of communication will suffice), determining the addressees and type of message, and determining the security classification and precedence. The originator must make sure that the prescribed message form is properly used, that the text is drafted according to procedure, and that the message is signed by the releasing officer. The originator is also responsible for forwarding the message to the appropriate agency for transmission.

DRAFTER

The drafter is a person who actually composes a message for release.

RELEASING OFFICER

The releasing officer is a person who authorizes the transmission of a message for and in the name of the originator.

TYPES OF MESSAGES

The types of messages transmitted by communication means are the following:

Single address

Multiple address

Book

General

Single Address

A single-address message is one destined for only one addressee.

Multiple Address

A multiple-address message is one that is destined for two or more addressees, each of whom must be informed of the other addressees. Each addressee must be indicated as ACTION or INFORMATION. The number of multiple-address messages must be reduced to the essential minimum, since processing them is one of the major factors contributing to delay in message handling. In addition, originators should always consider specifically whether all addressees must be informed of the other addressees of each message, and if not, a BOOK message should be used.

Book

A book message is one that is destined for two or more addressees and is of such a nature that the originator considers that no addressee need be informed of any other addressee. Each addressee must be indicated as action or information.

General

General messages are messages that have a wide standard distribution. They are assigned an identifying title and usually a sequential serial number; example, ALCONCEN 50.

Book and general messages are normally received by radio.

ADDRESS OF MESSAGE

Most messages have at least one addressee responsible for taking action on the contents and for originating any necessary reply. Other addressees with an official concern in the subject of the message but who do not have the primary responsibility for acting on it receive the message for information. Do not be confused by the term *information addressee*. Even though an information addressee usually is concerned only indirectly with a message, frequently action of some nature must be taken within the command. Some messages have only information addressees. Exempt addressees are used when the originator desires to exclude one or more authorities from a collective title.

PROSIGNS

LEARNING OBJECTIVES: Define *prosign*.
Match prosigns with their meanings.

Procedure signs, or prosigns, consist of one or more letters or characters or combination thereof, used to aid communication by conveying, in a condensed form, certain frequently used orders, instructions, requests, and information relating to communication. Figure 3-1 is a list of prosigns, and their meanings, that are authorized for use in visual signaling. No others may be used. An overscore (a line over two or more letters) indicates that the letters overscored are to be transmitted as a single character (no pause between letters). ACP 13°, *Communications Instruction, Visual Signaling Procedures*, contains the procedures for the use of prosigns.

NAVAL MESSAGE FORMAT

LEARNING OBJECTIVE: Identify the parts, components, and elements of the basic naval message format.

Figure 3-2 shows a message copied as received by flashing light. Figure 3-3 represents the standard format of naval messages. Study the figure and compare it with the message.

Each message prepared in either plaindress, abbreviated codress, or codress will have three parts: heading, text, and ending. Each message part has certain components, which are broken down into elements and contents. Format lines 2, 3, 4, 14, 15, and 16 (fig. 3-3) identify the procedural portions of the

Prosign	Meaning
\overline{AA}	Unknown station (flashing light only)
AA	All after
AB	All before
\overline{AR}	End of transmission
\overline{AS}	Wait
B	More to follow
\overline{BT}	Long break (separates text from other parts of message)
C	Correct
C	Answer sign (semaphore only)
D	Reduce brilliancy or use smaller light
DE	From
EEEEEEEE	Error
F	Do not answer
G	Repeat back
GR (numeral)	Group count
GRNC	Groups not counted
$\overline{HM} \overline{HM} \overline{HM}$	Emergency silence sign
II	Separative sign
\overline{IM}	Repeat
INFO	Information addressee sign
\overline{INT}	Interrogatory
\overline{IX}	Execute to follow
\overline{IX} (5-second flash)	Executive signal
J	Verify with originator and repeat
K	Invitation to transmit
L	Relay or relayed (Flashing light and semaphore only)
NEGAT	Exempted addressee sign (flaghoist only; equivalent of XMT)
NR	Number
\overline{OL}	Show steady dim light (Flashing light only)
\overline{PT}	Call sign follows (flashing light and semaphore only)
R	Received
T	Transmit to
TO	Action addressee sign
W	Information addressee sign (flaghoist only)
W	Your light is unreadable (flashing light only)
WA	Word after
WB	Word before
XMT	Exempted addressee sign
Z	FLASH precedence
O	IMMEDIATE precedence
P	PRIORITY precedence
R	ROUTINE precedence

Figure 3-1.—Authorized prosigns and their meanings.

VISUAL MESSAGE
 OPNAV FORM 2110-30 (10-56)
 Reorder from FPSO Ceg "F" stock points

CALL UP OHWZ DE NQHS

HEADING
 T P 061933Z MAR 95 FM NQHS TO OHWZ INFO XGHL
 XMT NFZV GR30 BT

UNCLAS	TROOP	MOVEMENT	1.	EXPECT	5
DEBARK	GROUPS	070830H	MAR	95	10
AT	IWAKUNI	2.	BUS	TRANSPORTATION	
ARRANGED	3.	NEW	GROUP	TO	20
ARRIVE	071330H	MAR	95	4.	25
REQUEST	COMPOSITION	OF	NEW	GROUP	30
BT	C	WA	DEBARK	TROOPS	35
K		XGHL			40
		DE	FL		45
		OHWZ			50
		BT 2041Z/06 MAR 95			55
					60

FROM: USS BLUE RIDGE	DATE: 06 MAR 95	RELEASED BY:			
TO: COMPHIBRON 3	SYSTEM: FL	PRECEDENCE: PRIORITY			
	OPERATOR: JLR	SUPERVISOR: LBM			
INFO: PHIBRON 3 XMT USS OGDEN	TOP: 2005Z	VISUAL HR: 10			
FLAG	C OF S	CAPT	OOD	COMM. CEN.	DTG: 061933Z MAR 95

73NP0034

Figure 3-2.—Plaindress visual message.

basic message format as designed for visual communications. Lines 5 through 13 are the nonchangeable elements of the basic message format. All format lines do not necessarily appear in every message; however, when used, they will be in the order indicated.

Of the three parts of a message, the most complex (as fig. 3-3 indicates) is the heading. Based on heading content, messages may be drawn up in one of three forms: plaindress, as in figure 3-2; abbreviated plaindress, featuring a shortened heading; and codress, used for encrypted messages. We will point out the differences following the discussion of the plaindress message.

PLAINDRESS MESSAGES

The heading of a plaindress message is made up of four components: procedure, preamble, address,

and prefix. These components provide operating personnel with necessary information for transmitting, identifying, delivering, and accounting for each message.

Procedure Component

In visual messages, the procedure component consists of three elements: call, transmission identification, and transmission instructions. The call contains call signs of the station(s) called and the calling station. Transmission identification is not normally used in visual communications except in messages being relayed. Transmission instructions are concerned with routing, relaying, and delivering a message.

The beginning procedure component of the message in figure 3-2 is OHWZ DE NQHS T. Of this

PARTS	COMPONENTS	ELEMENTS	FORMAT LINE	CONTENTS
			1	Not used.
H	Procedure (Note 1)	Call	2	Prosign F (see paragraph 315, ACP 129), stations called (prosign XMT, exempted calls) prosign DE and station calling.
E		Transmission Identification	3	Station serial number.
A	Preamble	Transmission Instructions	4	Prosigns F, G, T, L; operating signals; call signs, address groups, plain language address designators.
D		Precedence	5	Precedence prosigns.
I		Date-time group		Date and time expressed in digits, and zone suffix followed by month indicated by the first three letters, and if required by national authorities, the year indicated by the last two digits.
N		Message Instructions		Operating signals; prosign IX.
G				
	Address (Note 2)	Originator's sign	6	Prosign FM.
H		Originator		Originator's designation (call sign, address group, plain language address designator).
E	Action addressee sign Action addressees	Action addressee sign	7	Prosign TO.
A		Action addressees		Action addressees' designations (call signs, address groups, plain language address designators).
D	Information addressee sign Information addressees	Information addressee sign	8	Prosign INFO.
I		Information addressees		Information addressees' designations (call signs, address groups, plain language address designators).
N	Exempted addressee sign Exempted addressees	Exempted addressee sign	9	Prosign XMT.
G		Exempted addressees		Exempted addressees' designations (call signs, address groups, plain language address designators).
H	Prefix	Accounting information	10	Accounting symbol.
E		Group count		Prosign GR (numerals) or GRNC.
A				
D				
I				
N				
G				
	SEPARATION		11	Prosign \overline{BT} .
T	Text	Subject matter	12	Security classification or UNCLAS as appropriate when required; the abbreviation SVC; internal instructions; thought or idea as expressed by the originator.
E				
X				
T				
	SEPARATION		13	Prosign \overline{BT} .
E	Procedure	Time group	14	Hours and minutes expressed in digits, and zone suffix.
N		Final instructions	15	Prosigns \overline{AS} , B, C, G, \overline{IMI} , GR (numerals), \overline{IX} (5 second flash), operation signals.
D	Ending sign	Ending sign	16	Prosign K or \overline{AR} .
I				
N				
G				

NOTE 1: Plain language address designators shall not be used in any component of codress messages.

NOTE 2: The address component is prohibited with codress procedure.

Figure 3-3.—Parts of a naval message.

portion, OHWZ DE NQHS constitutes the entire call element.

The call sign of the station called is OHWZ. For illustrative purposes, OHWZ is assumed to be the call sign for Commander Amphibious Squadron Three. Call signs in Navy messages reduce the length of transmission. Each ship, station, and command of the Navy (and of the other services) has one or more call signs, that are listed in various communication publications. Call signs are discussed in more detail later in this chapter.

The prosign DE in the message stands for "from." It is used only in the call. Its complete meaning is "This transmission is from the station whose designation follows." It indicates the station actually transmitting the message or signal and only indicates the originator when the call is serving as the address.

In the example, the calling station is NQHS, the international call sign of USS *Blue Ridge* (LCC 19). International call signs for U.S. Navy and U.S. Coast Guard ships begin with the letter *N*.

In figure 3-2, transmission instructions consist of prosign T, meaning "Station called transmit this message to all addressees appearing in the address component." OHWZ, therefore, is responsible for delivering the message to XGHL. If the T were immediately followed by call signs or address designations, it would assume the meaning of "Station called transmit this message to the addressees whose address designations follow." Similarly, if the T were preceded and followed by call signs, it would mean "Station preceding T transmit this message to those addressees whose address designations follow T."

Other prosigns that may appear in transmission instructions are G ("Repeat back"), F ("Do not answer"), and L ("Relay"). Prosign G is used by a transmitting station to ensure that the receiving station has received the message as transmitted, particularly if the message is of great importance or of a type difficult to send or receive. If G appears alone in the transmission instructions, all stations called repeat back the message; if G is preceded by call signs, it means that stations whose call signs precede G repeat back the message. Prosign F means "Do not answer." It is used in a method of visual signaling that will be discussed in chapter 4. Prosign L is the relay sign. Its meaning is similar to T, but is not as specific. In transmission instructions, L means "Relay to those addressees for whom you are responsible." Its use also requires that the station called report to you that the

message has been relayed. The elements of the procedure component are assigned by communications personnel to effectively deliver the message or signal. The elements of the preamble, address, and prefix component, which follow, are released by the originator and are not altered by communications personnel.

Preamble

The preamble of a plaindress message shows its relative importance; contains the date-time group, by which most messages are identified; and provides information relating to the message. The preamble in figure 3-2 is P 061933Z MAR 95. P is a precedence prosign, and the remainder is the date-time group, including month and year, of transmission.

The precedence assigned by an originator reflects a judgment as to the speed required to deliver the message to the addressee. By misusing the precedence system, you defeat its purpose, which is to assure rapid handling of message traffic over available facilities with a minimum of backlog and delay resulting from competing messages. The importance of a message does not necessarily imply urgency. Figure 3-4 shows the precedence categories, their speed-of-service objectives, and examples of their assignments.

Messages having both action and information addressees may be assigned a single or dual precedence. If a single precedence is assigned to a multiple-address message, the precedence indicates the relative importance to all addressees. If assigned two precedences, one for action addressees and a lower precedence for information addressees, the message is of greater importance to the action addressees.

If the message in figure 3-2 were assigned dual precedence, the preamble would read P R 061933Z MAR 95. This would show that the message should be treated as a priority message for delivery to OHWZ and as a routine message when delivered to XGHL. Dual-precedence messages, in visual signaling, normally are handled as single-precedence messages because of the proximity of ships and signaling stations. If, however, the action addressee of a dual-precedence (for example, P R) message were in company but one or more information addressees were not, relay would be required. In that instance, the message would be sent immediately to the action addressee, but might be transmitted to a different station for relay to the information addressees, using

PROSIGN	DESIGNATION	DEFINITION AND USE	HANDLING REQUIREMENTS
Z	FLASH	<p>FLASH precedence is reserved for initial enemy contact messages or operational combat messages of extreme urgency. Brevity is mandatory. Examples:</p> <ol style="list-style-type: none"> (1) Initial enemy contact reports. (2) Messages recalling or diverting friendly aircraft about to bomb targets unexpectedly occupied by friendly forces; or messages taking emergency action to prevent conflict between friendly forces. (3) Warnings of imminent large-scale attacks. (4) Extremely urgent intelligence messages. (5) Messages containing major strategic decisions of great urgency. 	<p>FLASH messages are hand-carried, processed, transmitted, and delivered in the order received and ahead of all other messages. Messages of lower precedence will be interrupted on all circuits involved until handling of the FLASH message is completed.</p> <p>Time Standard: As fast as possible with an objective of less than 10 minutes.</p>
O	IMMEDIATE	<p>IMMEDIATE is the precedence reserved for messages relating to situations that gravely affect the national forces or populace, and require immediate delivery to the addressee(s). Examples:</p> <ol style="list-style-type: none"> (1) Amplifying reports of initial enemy contact. (2) Reports of unusual major movements of military forces of foreign powers in time of peace or strained relations. (3) Messages that report enemy counterattack or request or cancel additional support. (4) Attack orders to commit a force in reserve without delay. (5) Messages concerning logistical support of special weapons when essential to sustain operations; messages concerning death or serious illness. (6) Reports of widespread civil disturbance. (7) Reports or warnings of grave natural disaster (earthquake, flood, storm, etc.) (8) Requests for or directions concerning distress assistance. (9) Urgent intelligence messages. (10) Requests for news of aircraft in flight, flight plans, or cancellation messages to prevent unnecessary search/rescue action. (11) Messages concerning immediate movement of naval, air, and ground forces. 	<p>IMMEDIATE messages are processed, transmitted, and delivered in the order received and ahead of all messages of lower precedence. If possible, messages of lower precedence will be interrupted on all circuits involved until the handling of the IMMEDIATE message is completed.</p> <p>Time Standard: 30 minutes.</p>
P	PRIORITY	<p>PRIORITY is the precedence reserved for messages that furnish essential information for the conduct of operations in progress. This is normally the highest precedence for administrative messages. Examples:</p> <ol style="list-style-type: none"> (1) Situation reports on position of front where attack is impending or where fire or air support will be soon placed. (2) Orders to aircraft formations or units to coincide with ground or naval operations. 	<p>PRIORITY messages are processed, transmitted, and delivered in the order received and ahead of all messages of ROUTINE precedence. ROUTINE messages being transmitted should not be interrupted unless they are extra long and a very substantial portion remains to be transmitted. PRIORITY messages should be delivered immediately upon receipt at the addressee destination. When commerial refile is required, the commerial precedence that most nearly corresponds to PRIORITY is used.</p> <p>Time Standard: 3 hours.</p>
R	ROUTINE	<p>ROUTINE is the precedence to use for all types of messages that justify transmission by rapid means unless of sufficient urgency to require a higher precedence. Examples:</p> <ol style="list-style-type: none"> (1) Messages concerning normal peacetime military operations, programs, and projects. (2) Messages concerning stabilized tactical operations. (3) Operational plans concerning projected operations. (4) Periodic or consolidated intelligence reports. (5) Ship movement messages, except when time factors dictate use of a higher precedence. (6) Supply and equipment requisition except when time factors dictate use of a higher precedence. (7) Administrative, logistic, and personnel matters. 	<p>ROUTINE messages are processed, transmitted, and delivered in the order received and after all messages of a higher precedence. When commerial refile is required, the lowest commerial precedence is used. ROUTINE messages received during nonduty hours at the addressee destination may be held for morning delivery unless specifically prohibited by the command concerned.</p> <p>Time Standard: 6 hours.</p>

Figure 3-4.—The precedence of a message indicates its relative importance. Note time standards for handling.

Routine precedence. Transmission for relay, of course, would be delayed until all higher precedence traffic is cleared.

The date-time group (DTG) indicates the approximate time a message was readied for transmission. Normally, the DTG is assigned by the communications watch officer or signal officer. The DTG in figure 3-2 indicates the message was ready for transmission at about 1933 Greenwich mean time (is the zone suffix) on the 6th day of March.

Because the DTG serves as a positive means of identification, no DTG should be assigned by any station to more than one outgoing message. If for some reason you have to assign a DTG, be sure to inform the communications center of the DTG you used.

Figure 3-2 has no message instruction element. The use of operating signals and the prosign IX will be discussed in chapter 4.

Address Component

The address component of figure 3-2 is FM NQHS TO OHWZ INFO XGHL XMT NFZV. This component shows who originated the message, the addressee for action, the addressee for information, and the exempt addressee. Provision is also made to show which, if any, addressees included in a collective call sign need not receive the message. (A collective call sign represents two or more ships, stations, or commands.)

The address component of the message is determined by the drafter and originator. Communications personnel are authorized to convert the plain-language addressees to call signs or address groups when processing messages for transmission.

All four prosigns that can be included in the address component appear in the example message. The originator's sign, FM, means "The originator of this message is indicated by the designation immediately following." The prosign for action addressee, TO, means "Addressees indicated by the designation immediately following are addressed for action." The information addressee sign, INFO, followed by call signs, shows that the message is for information only.

The exempted addressee sign, prosign XMT, means that addressees following XMT are exempted from the collective address. If a collective call is also used, the prosign XMT must also appear in the call element. It appears as the last element in the address component, following the action and information addressees' designations.

If the call element gives all the addressees, the address component of a message may be omitted. In the example message, if there were no information addressees, the call would serve as the address. The address component could then be omitted.

Prefix

The prefix of a plaindress message contains accounting symbols and the group count.

Accounting symbols are included in Navy messages when a possibility exists that they may be transmitted over commercial facilities. Instructions for the use of accounting symbols are found in JANAP 128.

The group count of a message is the number of groups in the text. In a message, GR followed by numeral(s) means "This message contains the number of groups indicated." In a message containing a text of 26 words, the group count is written GR26. If the message were encrypted, the group count would indicate the number of code groups in the text. The group count normally appears in the message prefix, but in certain cases may appear in the final instructions. When a message is transmitted before the group count is determined, the prosign GRNC may be used in lieu of the group count. The actual group count will then be transmitted in the final instructions and inserted in the message prefix by the receiving operator.

Rules to follow when counting groups are the following:

Count groups in the text only.

Each sequence of characters uninterrupted by a space is counted as one group.

Punctuation is not counted unless abbreviated or spelled out.

Count every word and every continuous combination of letters, figures, and/or symbols as one group.

Hyphenated words and hyphenated names, when transmitted as one word, count as one group.

A numerical group count always must be used in encrypted messages. The group count element may be omitted in messages where the text consists of plain language.

Long Break

The long-break prosign, BT, marks the separation between the text and other parts of a message. It immediately precedes and follows the text. In

abbreviated service messages, the \overline{BT} is not used except when a date-time/time group is employed.

Text

The textual format of Navy messages is designed to make the messages easily readable yet keep them concise to conserve time and facilities so that all necessary messages can be sent. The text of the

example message in figure 3-2 conforms to the standard format for plain-language messages. When processed by the communications center, the text is placed in the form shown in figure 3-5.

Exempt from the standard format are messages with very short texts. Examples are tactical messages and pro form messages using a firmly established format, such as standard "reporting-type" messages

JOINT MESSAGE FORM							SECURITY CLASSIFICATION			
PAGE	DTG/RELEASE TIME			PRECEDENCE		CLASS	SPECIAL	LMP	CIC	ORIG. MSG IDENT
	DATE TIME	MONTH	YR	ACT	INFO					
01 of 01	051600Z	MAR	95	PP	RR	UUU				2291600
GROUP	MESSAGE HANDLING INSTRUCTIONS									
<p>FROM: USS BLUE RIDGE</p> <p>TO: COMPHIBRON THREE</p> <p>INFO PHIBRON THREE</p> <p>XMT USS OGDEN</p> <p>UNCLAS //NOFORN//</p> <p>SUBJ: TROOP MOVEMENT</p> <p>1. EXPECT DEBARK TROOPS 070630H MAR 95 AT IWAKUNI</p> <p>2. BUS TRANSPORTATION ARRANGED</p> <p>3. NEW GROUP TO ARRIVE 071330H MAR 95</p> <p>4. REQUEST COMPOSITION OF NEW GROUP</p>										
DISTR:										
DRAFTER TYPED NAME TITLE OFFICE SYMBOL PHONE							SPECIAL INSTRUCTIONS			
J.K. BROWN RM3 2-1336										
TYPED NAME TITLE OFFICE SYMBOL AND PHONE							SECURITY CLASSIFICATION			
S.J. SAILOR RM2 2-1301										
SIGNATURE							DATE TIME GROUP			
<i>S.J. Sailor</i>										

6
5
4
3
2
1
0

Figure 3-5.—Plaindress message processed by the communications center.

that use letters of the alphabet to indicate a prearranged subject matter. If all elements are required, they appear in the following order:

1. Classification or the abbreviation UNCLAS. The highest classification authorized for visual means, regardless of method, is Confidential.
2. Special category marking (EXCLUSIVE, COSMIC, and the like).
3. Special handling security markings (NOFORN, RESDAT, and so on).
4. Exercise identification (EXERCISE MAIN BRACE).
5. Code name or nickname of special projects or operations.
6. Flag word (EXPRESS, REDLINE, and so on.)
7. Passing instructions and other indications of message distribution (FOR)
8. Subject line, concise and untitled.
9. References, identified by letter(s).
10. Text:
 - a. Paragraphs are numbered.
 - b. Subparagraphs are indented and lettered or numbered as appropriate.
 - c. In a one-paragraph message, any subparagraphs are lettered.
 - d. If a message is classified, proper declassification markings are included.

If unclassified paragraphs or subparagraphs appear within a classified message, each number and/or letter will be followed by the abbreviated classification in parentheses; for example, A.(C), I(U).

Following is an example of a message using most of the elements of the standard text format:

```
UNCLAS//N01430//  
COMTWELVE PASS TO VADM SMITH  
REVISED CONFERENCE SCHEDULE  
A. MY/091700-Z MAR 95  
B. COMTHIRTEEN 131530-Z MAR 95  
1. REQUEST DESIGNATED COMMITTEE  
ARRIVE COM TWELVE 24 HOURS PRIOR CNO  
2. AGENDA:
```

- A. ADD "LOGISTICS OF PROJECT."
- B. DELETE "POSSIBLE LOCATION FACILITIES."
3. CNO ITINERARY, 19 AUG, TIMES UNIFORM:
ETA ETD LOCATION
ORIG 1300 NAS SEATTLE
1515 1800 NAS ALAMEDA
2300 TERM CHICAGO-OHARE

If a message does not require all elements, the format is adjusted accordingly by omitting nonessentials. Certain other exceptions are allowed when using the standard format.

The subject line may be omitted if it requires that an otherwise unclassified message be classified; if it noticeably increases the length of what would be a brief message; or if it increases commercial charges when the message is addressed to activities served by commercial communications facilities.

If a short message consists of only one paragraph, the paragraph is not numbered. When there is only one reference, the reference identification is included in the body of the paragraph. For example:

```
UNCLAS YOUR 100915Z MAR 95. BUDGET  
APPROVED SUBJECT TO CNO CONCURRENCE.
```

The first word of all plain language text messages must be either the abbreviation UNCLAS (unclassified), or the security classification of the message. Each message will be authorized by the commanding officer for transmission by directional visual communications. As a Signaller, you must be alert to prevent the transmission of any classified message not authorized for transmission.

Ending Procedure

The procedure component of the ending of a message contains three elements: time group, final instructions, and ending prosign. Normally a time group is not used in a plain dress message. The elements of the ending procedure are assigned by communications personnel to complete delivery of the message or signal.

In figure 3-2, the ending is C WA DEBARK TROOPS K. The first two prosigns and the two words constitute the final instructions of the message.

Standing alone, prosign C means "Correct." Because it is followed by other information in our example, it means "This is a correct version of the portion of the message indicated." Another prosign, WA, meaning "word after," follows certain prosigns (including C) to identify a portion of the text of a plain language message. In figure 3-2, the portion of the text identified is the word after DEBARK, which appears in the text as GROUPS. Accordingly, the final instructions of the message mean "Correct word after DEBARK to TROOPS."

Other prosigns may appear in the final instructions. Prosign C may be followed by AB, AA, or WB, instructing the receiving station to correct portions of the text. Prosign B used alone in the final instructions means "More to follow to all stations called." When B is followed by call signs, it means "More to follow to stations indicated."

Prosign G, for repeat back, may be used in the final instructions if, during transmission, its use is deemed necessary. Used alone, G directs all stations to repeat back the message. When G is preceded by a call sign (or signs), its meaning is "Stations whose call sign (or signs) precede G are to repeat back." In addition to its use in the transmission instructions and final instructions, G may be used in the text of a flashing light message to indicate the addressee is to repeat back the previous group sent by the transmitter.

Visual transmissions are completed by ending prosigns K or AR. The K means "This is the end of my transmission to you, and a response is necessary."

Ending prosign AR means "This is the end of my transmission to you, and no response is required or expected."

SERVICE MESSAGE

A service message is one between communications personnel and pertaining to any phase of traffic handling, communication facilities, or circuit conditions. It is prepared and transmitted in plaindress, abbreviated plaindress, or codress form.

The abbreviation SVC following any security classification or UNCLAS in the beginning of the text, identifies a plain-language service message.

An encrypted service message will always carry a numerical group and will only be identified as a service message within the encrypted text.

Service messages generally concern messages originated at, destined for, or refiled by that station and

normally will be assigned a precedence equal to that of the message to which they refer.

Examples of plain-language service messages:

___ 1. Plaindress format: P 031500Z MAR 95 GR10
BT UNCLAS SVC BRIDGE TO BRIDGE INOP
COME UP ON TGO BT K

2. Abbreviated plaindress format: BT UNCLAS
SVC BRIDGE TO BRIDGE INOP COME UP ON
TGO BT 1500Z

ABBREVIATED SERVICE MESSAGE

The text of an abbreviated service message contains only prosigns, operating signals, address designations, identification of messages, parts of messages, and amplifying data as necessary. It may be originated by operators and may contain any of the components shown in the basic format except that

1. The long break is used only if the date-time group/time group is used; and

2. The date time group/time group is to be employed only when it is necessary to indicate the time at which the message was originated or when it is considered that further reference may be made to the message.

Examples of abbreviated service messages:

1. INT ZDK NKZO 062222Z MAR 95 K

2. Abbreviated plaindress format: BT INT ZDK
NKZO 062222Z MAR 95 BT 2300Z K

___ 3. Plaindress format: P 062323Z MAR 95 GR 6
BT INT ZDK NKZO 062222Z MAR 95 BT K

ABBREVIATED PLAINDRESS MESSAGES

Operational requirements for speed of handling—contact reports, for example—may dictate the abbreviation of plaindress message headings. At such times, any or all of the following may be omitted from the heading: precedence, date, DTG, and group count. If the DTG is omitted, a time group must be in the ending procedure components.

CODRESS MESSAGES

A codress message is one in which the entire address, originator and all addressees except when the address indicating groups are used, is encrypted within the text. The heading of such a message contains only information necessary to enable

communications personnel to handle it properly. It contains all the components shown in figure 3-3.

STATION AND ADDRESS DESIGNATORS

LEARNING OBJECTIVES: Define station and address designators; explain procedures for constructing call signs and address groups. List procedures for establishing and maintaining communications.

Station and address designators are any combinations of characters or pronounceable words designed for use in message headings to identify a command, authority, unit, or communications facility, or to assist in the transmission and delivery of messages. Station and address designators encompass four categories: call signs, address groups, plain language, and routing indicators.

CALL SIGNS

Call signs are letters, letter-number combinations, or one or more pronounceable words used for establishing and maintaining communications. Call signs may also be used as address designators when the call sign indicates the addressee or originator. The following list contains the different types of call signs:

1. International
2. Indefinite
3. Net
4. Tactical
5. Voice
6. Visual
7. Signal letters of ships and signal letters or identification numbers of aircraft when used as international call signs

International Call Signs

International call signs are assigned to radio stations in all countries—civil and military, afloat and ashore—according to international agreement. The first letter or first two letters of a call indicate the nationality of the station. The United States has the first half of the *A* block (through *ALZ*) and all of the *K*, *W*, and *N* blocks. The United States reserves *A* calls for the Army and Air Force. The *K* and *W* blocks are

assigned to commercial and private stations, merchant ships, and others. The *N* block is for use by the Navy, Marine Corps, and Coast Guard.

Naval shore communication stations have three-letter *N* calls. If necessary, these calls may be expanded by adding numerical suffixes. Thus, additional call signs are provided for facilities located remotely from the parent station. Examples are the following:

NAM. . . .NAVCOMMSTA, Norfolk

NAM1Headquarters, CINCLANTFLT, Norfolk

NAM2Naval Shipyard, Norfolk

International call signs assigned to U.S. naval ships are four-letter *N* calls, which are used unencrypted only. They have no security value; hence they are authorized for use with Allied, civil, and merchant stations. An example follows:

NJUL. . . .USS *BAINBRIDGE* (CG(N) 25)

International call signs for USN, USMC, and USCG aircraft are composed of the service designator *N*, *NM*, or *NC*, respectively, followed by the last four digits of the serial number of the aircraft.

Indefinite Call Signs

Indefinite call signs represent no specific facility, command, authority, or unit, but may represent any one or any group of these. Examples:

NERK

NA through NZ (From) any U.S. Navy ship

Indefinite call signs are used in codress message headings to conceal the identity of originators and addressees. In such instances, the address component is placed in the encrypted text.

Net Call Signs

Net call signs represent all stations within a net. (A net is a group of stations in direct communication with each other on a common channel.) Normally, net call signs are not used in visual transmissions. Following is an example of a net call sign:

NQN. . . .All U.S. Navy radio stations in the Pacific guarding the ship-shore high-frequency calling series

Voice Call Signs

Voice call signs are letters, numbers, or a combination of letters and numbers that identify commands and units of commands. These include ships, aircraft squadrons and wings, shore establishments, type commanders, and task organization components. The voice call signs change daily using the system that is in effect at the time of this writing. The Navy continues to strive to improve security and at the same time provide an efficient and workable system of call sign identification.

Also available is JANAP 119, which contains ship and other joint armed forces voice call signs. Although the publication is always kept up to date, normally it is not used. JANAP 119 provides an adequate backup system, but lacks the security needed today.

Visual Call Signs

Visual call signs are primarily used for visual signaling. They are shorter than the other call signs or address groups assigned to an organization. This advantage is highly significant in determining the length of a flaghoist and reducing the transmission time of messages by other visual means.

Visual call signs may be used (1) to establish communication between organizations, (2) in the transmission instructions and address of a message that will be transmitted solely by visual means, and (3) for transmitting groups from authorized signal books, as follows:

1. To *address* ships, units, or commands, in which visual call signs precede the signals
2. To *complete, amplify, or vary* the meaning of a signal, in which case visual call signs are used in conjunction with the signal
3. To denote or indicate ships, units, or commands in which case visual call signs follow the signal

Visual call signs will not be used in the transmission instructions or address of a message to be transmitted or relayed by other than visual means. They may be used in the text when the text consists of signal groups. Visual call signs are as follows:

1. Calls for ships
2. Shortened visual calls
3. Unit or command call signs
4. Numeral pennant call signs

5. Special task organization call signs
6. Signal stations
7. Ships' boats
8. Convoys

In constructing visual calls to be transmitted by flaghoist, numerals are expressed by numeral pennants except when numeral flags are specifically indicated. Numerals appearing in visual call signs transmitted by any visual means other than flaghoist represent numeral pennants and are written as pl, p5, p6, and so on, to distinguish them from numeral flags. By any visual means other than flaghoist, call signs are transmitted using the Morse code or semaphore equivalents. All call signs (except radiotelephone) in the text of signals from an authorized signal book are preceded by the special sign PT transmitted as a Morse or semaphore equivalent meaning "call sign to follow." If more than one call sign appears in the text, each will be preceded by PT. Call signs in the text may be spelled out when conditions make this advisable, spelled out call signs will also be preceded by PT.

VISUAL CALLS FOR SHIPS.—Visual call signs for ships are either assigned nationally or constructed using the appropriate single-letter type indicator plus the hull number of the ship. A list of single-letter type indicators follows:

- A Auxiliary (oiler, cargo, tender, floating drydock, sloop, and so on.)
- B Battleship
- C Cruiser
- D Destroyer/destroyer escort
- F Frigate
- G Government station
- H Visual signal station (military)
- K Shore signal station (commercial) or miscellaneous fleet units (NATO use only)
- L Assault vessel (landing craft, amphibious transport dock, tank-landing ships, and so on.)
- M Minesweeper
- N Minelayer
- P Fast motor craft (submarine chaser, patrol escort, motor gunboat, motor torpedo boat, and so on.)
- Q Boat

- R Aircraft carrier
- S Submarine
- U Surface organization
- W Coast Guard ship
- X Submersible craft
- Y Support craft

For example, the visual call sign of USS *Fanning* (FF 1076) is Fp1p0p7p6; of USS *Forrestal* (CV 59), Rp5p9; of USS *England* (CG 22), Cp2p2.

If it happens that visual calls are the same for two or more ships in company or in the same port, their international call signs are used.

SHORTENED VISUAL CALLS.—Shortened visual calls are constructed by omitting unnecessary numbers. If the *Alamo* (LSD 33) were the only amphibious-type ship in the vicinity with the final digit of its hull as 3, its visual call would be Lp3.

UNIT INDICATOR CALL SIGNS.—Call signs for organized groups/flotillas, squadrons, divisions, and subdivisions of ships are constructed as follows:

- Subdiv-subdivision
- Div-this division
- Squad-squadron
- Group/flot-group/flotilla
- Example: Div—this division

By using the appropriate unit pennant with a type indicator preceding the unit pennant and numeral pennants following, you form the following visual call signs:

- Examples: R Squad p7—Carrier Squadron 7
- D Group/Flot p3—Destroyer Group/Flot 3

In calling commands and ships in the same unit, the unit indicator may be used alone. Thus, DIV alone would be the call for this division.

Type indicators may be omitted from call signs if no confusion could result. If cruiser-destroyer group 1 were in port with no other ship group 1 present, the call for CruDesGru 1 could be FLOT/GROUP p1.

To form the visual call sign of the commanders of an organized group/flotilla, squadron, division or

subdivision of ships the unit indicator is followed by the type indicator.

Example:

Squad D—Commander this destroyer squadron

Group/Flot CDp2—Commander cruiser destroyer group/flotilla 2

Call signs for a group of ships associated with an individual ship that is not organized as a task unit or element is constructed by prefixing Subdiv to the call sign of the identifying ship. The command call is constructed by prefixing the ship's call to Subdiv.

Examples:

Subdiv Rp6p9—USS *Eisenhower* Subdivision

Rp6p9 Subdiv—Commander *Eisenhower* Subdivision

NUMERAL PENNANT CALL SIGNS.—Listed in figure 3-6 are numeral pennant call signs for general use in tactical organizations. To form the call sign for the commander of one of these groups or units, precede the listed call with pennant 0. Thus, “Entering or leaving harbor group No. 2” is p5p2. This call includes all units of the group, as well as the commander and subordinate commanders. To address only the commander of the group, the call sign is p0p5p2.

To call the commander of the unit indicated, pennant 0 may be used preceding the unit indicator call signs.

Similarly, to address subordinate commanders, p0p0 is used. A message to all squadron commanders under a group commander could use the call sign p0p0 SQUAD.

Other numeral pennant call signs may be used with type indicators to designate the type of ships in a unit. The call sign for all destroyers, for instance, is p2D.

SPECIAL TASK ORGANIZATION CALLS.—Visual call signs employing numeral flags and numeral pennants are used only in flaghoist communications within task organizations. These call signs always begin with a numeral flag followed by numeral pennant(s) that indicate the number of the task organization. Type indicator may be used following the call sign.

Call Sign	Meaning	Call Sign	Meaning
p0	(Singly) My Immediate superior in tactical command	p5p1	Entering/leaving harbor group No. 1
p0	Commander of (type and/or unit)	p5p2	Entering/leaving harbor group No. 2
p0p0	Commanders under my command	p5p3	Entering/leaving harbor group No. 3
p0p1	Officer in tactical command	p5p4	
p1	All ships under my tactical command	p5p5	Escort force (group)
p2	All ships	p5p6	Fire support group (unit)
p3	Main body	p5p7	Flank groups (both flanks)
p4	This line	p5p8	Flank group (left)
p5	Screen	p5p9	Flank group (right)
p6	This task force	p6p0	Fueling units (oilers)
p7	This task group	p6p1	Fueling group (ships fueling)
p8	This task unit	p6p2	Hunter/killer group
p9	This task element	p6p3	Logistic support group
p1p0	All task force commanders	p6p4	Minelaying group
p1p1	All task group commanders	p6p5	Minesweeping group
p1p2	All task unit commanders	p6p6	
p1p3	All task element commanders	p6p7	
p1p4**		p6p8	Patrol group
p1p5**		p6p9	Pickets
p1p6**		p7p0	Pouncers
p1p7**		p7p1	Reconnaissance group (unit)
p1p8**		p7p2	Replenishment (group)
p1p9**		p7p3	Rescue destroyer(s)
p2p0	Advance force (group)	p7p4	Reserve force (group)
p2p1*	All units on circle 1	p7p5	Reserve replenishment group (unit)
p2p2*	All units on circle 2	p7p6	Retirement group
p2p3*	All units on circle 3	p7p7	Screening group
p2p4*	All units on circle 4	p7p8	Screening units under my command
p2p5*	All units on circle 5	p7p9	Scouting group
p2p6*	All units on circle 6	p8p0	Search and rescue group
p2p7*	All units on circle 7	p8p1	Service line (first)
p2p8*	All units on circle 8	p8p2	Service line (second)
p2p9*	All units on circle 9	p8p3	Service line (third)
p3p0	All units in This Exercise	p8p4	Senior officer present afloat (SOPA)
p3p1	All units this column (or column indicated by numeral pennant(s) following)	p8p5	Senior officer present afloat (administrative)
p3p2	Amphibious force	p8p6	Striking force (group)
p3p3	ASW carrier group	p8p7	Support force (group)
p3p4	ASW covering group	p8p8	Surface action force (group)
p3p5	Attack force (group)	p8p9	Search attack unit (SAU)
p3p6	Battle line	p9p0	Transport group
p3p7	Carrier group	p9p1	Waiting line (first)
p3p8	Carrier support group	p9p2	Waiting line (second)
p3p9	Carrier and rescue destroyers	p9p3	Waiting line (third)
p4p0	Center group	p9p4**	
p4p1	Close covering group	p9p5**	
p4p2	Convoy (to indicate or denote)	p9p6**	
p4p3	Demonstration force (group)	p9p6**	
p4p4	Detached wing	p9p7**	
p4p5**		p9p8**	
p4p6**		p9p9**	
p4p7**			
p4p8**			
p4p9**			
p5p0**			

*Units on a partial circle may be indicated by a third pennant.
**For local assignment by task force commanders or high authority.

Figure 3-6.—Numeral pennant call sign for use in tactical organizations.

Following is the table of special task organization visual call signs listed in ACP 129.

<u>Call sign</u>	<u>Meaning</u>
(Numeral flag)	
Ø	Commander Task Force No. _____
1	*Commander Task Group No. _____
2	*Commander Task Unit No. _____
3	*Commander Task Element No. _____
4	Commander _____ Fleet
5	
6	Task Force No. _____
7	*Task Group No. _____
8	*Task Unit No. _____
9	*Task Element No. _____

* Within own task organization

Examples:

6p4p5 . . . Task Force 45

8p3 Task Unit 3 (within own Task Group)

9p2D Destroyers of Task Element 2 (within own Task Unit)

3p6. Commander Task Element 6 (within own Task Unit)

The special task organization call signs in the previous list have been extended to intra-USN messages transmitted by flashing light.

Examples:

CTF 50. Zero p5p0

CTG 50.3 One p3

COMSIXTHFLT. Four p6

TF 50. Six p5p0

TG 50.3.5 Seven p5

CONVOY VISUAL CALL SIGNS.—Convoy visual call signs are contained in ATP 2, volume 2, or appropriate national or regional defense organization publications.

GOVERNMENT SIGNAL STATIONS.—On shore or on lightships, use the letter *G* as the visual call sign to call any or all the senior men-of-war.

SHORE SIGNAL STATION.—In compliance with international procedure, the letter *K* (with complement if desired) is used to call or address shore stations.

MILITARY SIGNAL STATION.—The following assignments are reserved for the signal station indicated:

<u>Call sign</u>	<u>Meaning</u>
Hp0	Commander in chief
Hp1	Harbor entrance control post/port war signal station (HECP/PWSS) (main signal station)
Hp2	HECP/PWSS (secondary auxiliary signal station)
Hp3	Port director
Hp4	Senior officer present afloat (SOPA) (when ashore)
Hp5	SOPA administrative (when ashore)
Hp6	Flag officer, second in command
Hp7	Commander naval district
Hp8	Commander naval base
Hp9	Commander naval operating base
Hp1p0	Commander naval shipyard
Hp1p1	Commander sea frontier
Hp1p2	Commander air station
Hp1p3	Commander amphibious base
Hp1p4	Commander section base
Hp1p5	Commander submarine base
Hp1p6	Degaussing station No. 1
Hp1p7	Degaussing station No. 2
Hp1p8	Degaussing station No. 3
Hp1p9	Degaussing station No. 4
Hp2p0	Deperming station No. 1
Hp2p1	Deperming station No. 2
Hp2p2	
Hp2p3	
Hp2p4	
Hp2p5	
Hp2p6	
Hp2p7	
Hp2p8	
Hp2p9	
Hp3p0)	Reserved for local assignment by competent authority to shore signal stations not covered herein.
)	
)	
)	
Hp3p9)	

SHIPS' BOATS.—The following visual call signs are assigned for ships' boats.

Qp0	All boats
Qp1	Admiral's barge
Qp2	Chief of staff barge or gig
Qp3	Staff gigs or motorboats
Qp4	Captain's gig
Qp5	Boats under power
Qp6	Boats under sail
Qp7	Boats under oars
Qp8)	Reserved for local assignment by commanding officers. Calls are generated according to boat numbers.
)	
)	
Qp5p0)	

Boat calls consist of QUEBEC hoisted above numeral pennant(s). Together, they signify the type of boat(s) called. Numeral flags following the call sign indicates the individual number of the boat. Thus, Qp54 is the call sign a ship would use for its utility boat number 4. To call another ship's boat, the call of the ship is hoisted below the boat call. For example, Qp4Rp1p4 is the captain's gig of carrier 14.

ADDRESS GROUPS

Address groups are four-letter groups assigned to represent a command, activity, or unit. Although address groups are used mainly in the message address, they can be used in military communications to establish and maintain communications in the same manner as call signs. In general, call signs and address groups are used by the Navy in the same way.

Address groups never start with the letter *N*; hence, they are easily distinguishable from naval radio call signs. Unlike international call signs, address groups follow no distinctive pattern. For example, you learned the difference in call signs for naval ships and shore stations. In address groups, however, the arrangement of the four letters is not significant.

All commands afloat (except individual ships) are assigned address groups. Address groups are assigned also to shore-based commands, authorities, or activities not served by their own communication facilities. More specifically, these are (1) senior commands and commanders ashore, such as the Secretaries of Defense and of the Navy, bureaus and offices of the Navy Department, and district

commandants; (2) fleet, type, or force commanders ashore; (3) elements of operating forces permanently ashore who are in frequent communication with forces afloat; and (4) elements of the shore establishment (such as weather centrals) having a need for direct addressing and receipt of the messages.

Among other uses, address groups aid in the delivery of messages when a communications center serves so many activities that its own call sign is insufficient to identify the addressee.

Address groups, like call signs, are divided into types. They are individual activity, collective, conjunctive, and geographic address groups, and address indicating groups.

Individual Activity Address Groups

Individual activity address groups are representative of a single command or unit, either afloat or ashore. Examples:

DTCI COMPHIBLANT
SSMW CNO

Collective Address Groups

Collective address groups represent two or more commands, authorities, activities, units, or combinations of these. Included in the group are the commander and subordinate commanders. Examples:

DSWN. DESRON 16
AMGK SIXTH FLT Conjunctive Address Groups

Conjunctive Address Groups

You must remember that conjunctive address groups have incomplete meanings. It is always necessary to complete the meaning by the addition of other address groups denoting a specific command or location. For that reason, conjunctive address groups are used only with one or more other address groups. The conjunctive address group XZKW, for example, means "All ships present at _____." This particular group must be followed by a geographic address group to complete the meaning.

Geographical Address Groups

Geographic address groups should be included as a part of an address designator only when necessary to complete the titles of addressees or originators, in

which case they are used in combination with a conjunctive address group. Except where a geographical address group is required to complete the conjunctive address group, geographical address groups should not be used with the name of naval or merchant ships or the title of commands afloat.

Address Indicating Groups

An address indicating group (AIG) is a form of military address designator representing a predetermined list of specific and frequently recurring combinations of action and/or information addressees. The identity of the originator may also be included if the AIG is used frequently by any one originator. Each AIG is numbered so it will be easy to identify. An address group is assigned to each AIG for use as an address designator. AIG numbers may also be used as plain language address designators when appropriate.

The purpose of AIGs is to increase the speed of traffic handling and to reduce the length of the address component. Address indicating groups can be used whenever suitable, regardless of whether the message concerned is unclassified or classified, unencrypted or encrypted, or in plain dress or codress form.

Special Operating Groups

Special operating groups comprised of four letters and identical in appearance with address groups are provided for use in the headings of messages to give special instructions. They are not to be used until a nation or service has promulgated instructions authorizing their use. They must always be encrypted. They may be used singly, or with encrypted or unencrypted call signs or address groups.

PLAIN LANGUAGE STATION AND ADDRESS DESIGNATORS

Plain language address designators are the official abbreviated, or short titles, of commands or activities. They are used in message headings in place of call signs or address groups. Some abbreviated titles are written as single words, such as NAVSEA. Others have conjunctive titles and geographical locations, such as NAVCOMMSTA PUERTO RICO.

Plain language designators normally are confined to the abbreviated title of commands and activities listed in the *Standard Navy Distribution List*. They may be used in communication with the U.S. Army, Air Force, and the armed forces of our Allies. They

may not be used when addressing a message to a nonmilitary activity, in the heading of a codress message, or in radiotelegraph messages originated by naval forces afloat.

INCOMING MESSAGE PROCEDURE

LEARNING OBJECTIVE: Discuss the procedure for handling and distributing incoming and outgoing messages.

The manner in which incoming messages are handled and distributed aboard ship is in accordance with stipulated shipboard communication doctrine or as determined otherwise by the OOD. Messages bearing a higher precedence than Routine receive particular attention, whether they are administrative or tactical in nature. There may be special procedures for Flash and Immediate visual traffic.

In general, incoming nontactical messages are recorded on a message blank, shown to and initialed by the OOD, and delivered promptly to the communications center for distribution. In the case of a high-precedence message, however, the OOD usually orders the signal supervisor to have it shown immediately to the captain.

If you are the signal supervisor, relay all tactical signals to both the OOD and CIC (the latter by intercom, usually the 21MC circuit). The OOD or JOOD refers to the appropriate signal book to interpret the signal's meaning. The signal is also interpreted in CIC. The CIC watch officer informs the OOD of its meaning. If both interpretations agree, the OOD will order you to indicate receipt for the message.

There are excellent reasons for requiring two interpretations of each tactical signal. For one thing, the practice keeps CIC informed of the ship's possible movements. For another, there are many signals, particularly for maneuvering, and there must be no error on the part of message addressees, because of the danger of collision. When OOD and CIC agree to the meaning of a signal, the OOD orders the signal acknowledged. On the rare occasion when there is disagreement, the OOD uses his or her judgment as to the better interpretation.

SUMMARY

In this chapter you learned how to originate messages, and you became familiar with the many

types of messages that you will be in contact with while performing your duties as a Signaller. You learned how to prepare messages for transmission using the standard naval message format and how to construct call signs and what type and unit indicators are. You also learned

what prosigns are and how to use them. This chapter is very important to the Signaller rating. Learn all you can about messages, and apply the knowledge as necessary. Take the initiative to schedule practice during your spare time.

CHAPTER 4

ALLIED COMMUNICATION PROCEDURES

In addition to operating equipment and constructing messages, you must use correct communication procedures to provide concise and definite language so that communications may be conducted accurately and rapidly. The method of communicating may depend on a number of considerations, ranging from security to required speed of transmission. Whatever the condition, you as a Signaller must be able to perform to the best of your ability.

Although Signallers normally use only three methods to communicate visually (flashing light, flaghoist, and semaphore) other methods such as sound and pyrotechnics are available. This chapter explains communication procedures used by communication personnel. Flaghoist procedures are covered in chapter 5.

GENERAL PROCEDURES

LEARNING OBJECTIVES: Explain the use of general procedures to eliminate lengthy transmissions, to maintain proper signaling discipline, and to determine the rule of visual responsibility.

Visual communications procedures may be subdivided into Allied, international, and special procedures.

Allied procedures are those used by the United States with its Allies and between Allied Nations.

International procedures, discussed in chapter 6, are those designed for nonmilitary communications between civil stations, but may be adapted for military use.

Special signal procedures are those not included under Allied or international procedures, such as those described in ATP 2, volume II. Other special signals include the following:

- Ship-shore movement signals
- Harbor tug control signals
- Signals for various foreign ports

- U.S. Navy and Allied fleet exercise signals

The foundation for these signal procedures is contained in ACP 129, *Communication Instructions, visual Signaling procedures*; ATP 2, volume II, *Allied Naval Control of Shipping Manual Guide to Masters*; ATP 1, volume II, *Allied Maritime Tactical Signal and Maneuvering Book*; and Pub 102, *International Code of Signals*.

OPERATING SIGNALS

Operating signals provide a brevity code for passing information pertaining to communication, aircraft operation, search and rescue, and so on. Although the signals eliminate the need for plain language transmissions between operators, they have no security and are in fact the equivalent of plain language. Operating signals are contained in ACP 131, *Communication Instructions Operating Signals*.

Description

Operating signals consist of three letters that start with either the letter *Z* or *Q* and may have figures, letters, abbreviations, or call signs following them. Most operating signals have complete meanings, but some require information to complete their meanings. The following rules apply:

1. Where a _____ appears, it must be filled in.
2. Where a (_____) appears, it is optional to complete.

Numbered alternatives, if used, will be followed without spacing.

Numeral flags must be used between Allied units. Numeral pennants must be used for the Q codes for non-Allied military stations and merchants.

Allocations

Allocations of operating signals are as follows:

QAA-QNZ: Allocated to the International Civil Aviation Organization (ICAO). The only civil stations that will have a copy of this series are those of the aeronautical service. Therefore, this series is not used

with other civil stations unless it is known that the station concerned is familiar with this series.

QOA-QQZ: Reserved for the maritime service.

QRA-QUZ: Allocated to the International Telecommunications Union (ITU). All civil stations should have a copy of this series. Therefore, this series may be used with all civil stations unless the station concerned indicates it is unfamiliar with the series.

QVA-QZZ: Not allocated.

ZAA-ZXZ: Allocated to the Allied military; held by all military stations.

ZYA-ZZZ: Reserved for temporary or permanent assignment of meanings on an intra-military basis by any nation, service, or command authorized use of ACP 131.

Use of Operating Signals

Operating signals either answer a question, give an order, or give advice.

Example: Order: ZJL—hoist the following signals.

Info: ZJI NKZO—Call sign of ship in company is NKZO.

In Allied military stations, a question or request can be implied by preceding the signal with the prosign INT.

Example: INT QRU—Have you anything for me?
INT ZJI—What are the call signs of ships in company with you?

In reply to a question, an affirmative or a negative sense can usually be implied by using just the basic operating signal.

Example: The reply to INT ZOE would be ZOE.

If desired though, the operating signal ZUE (affirmative) or ZUG (negative) may be used alone or in conjunction with the signal.

Example: The reply to INT ZOE may be ZUG or ZUG ZOE.

In non-Allied military or civil stations, a question can be implied by use of the prosign IMI following the signal.

Example: QAR 10 IMI—May I stop listening on the watch frequency for 10 minutes?

In reply to a question in the affirmative or negative sense, the letter *C* (affirmative) or *N* (negative) is used.

Example: The reply to QAR 10 IMI would be QAR 10C.

Call signs normally will follow the Q or Z signals; however, they also may precede the operating signal for separation or clarity.

Q and Z signals with numbered alternate meanings will be followed, without spacing, by the appropriate number to indicate the meaning intended.

Example: ZJH1 means: Your light is unreadable, not trained correctly.

Time groups used with Q or Z signals always will be followed, without spacing, by a zone suffix.

Any nation, service, or command may prohibit or restrict the military use, within its area of jurisdiction, of any operating signal. However, when such operating signals are received from other users, they must be recognized and acted upon.

A knowledge of operating signals is a must for all Signalmen. Section J of ACP 131 contains visual operating signals. Study this section to become more efficient in your job.

VISUAL RELAY RESPONSIBILITY

In visual communication, relaying is accomplished automatically when the call-up is made using collective call signs. A message should be relayed concurrent with its reception, when possible, to cut down the time delay between the end of the originator's transmission and its delivery to the final addressee.

Chain of Visual Responsibility

The general rule for determining the responsibility for any situation is that each addressee is responsible for delivery of the message to addressees beyond themselves in the general direction away from the originator. No rule set forth here, or prescribed by responsible commanders, is to be interpreted as restricting the initiative of any ship in relaying a message to an addressee who does not respond when called. It is the duty of any ship to expedite the transmission of a message by relaying when it is evident that she is in a better position to effect the necessary relay than the ship specifically responsible.

When a maneuver alters the position of units and ships relative to the officer in tactical command (OTC), the responsibility for relaying the signals does not alter until completion of the maneuver by all ships.

In single-line formations, any given ship is responsible for the ships beyond and in the direction away from the originating ship. In multiple-line formations, the senior officer is responsible for ships in his/her own line and line commanders of lines immediately adjacent to his/her own line. The line commanders in the multiple lines are responsible for ships in their own line and line commanders immediately adjacent but in a direction beyond and away from the originating ship. Individual ships are responsible for ships in their own line beyond and away from their own line commander.

In any operational formation or disposition, the chain of visual responsibility is governed by the rules set forth previously unless modified by responsible commanders. It may be necessary for a commander to issue detailed relaying instructions or diagrams showing sectors of visual responsibility, to make sure visual signals are cleared as quickly as possible. In assigning responsibility, a commander considers the relative capabilities of various ships, such as the type of visual equipment installed, personnel limitations, and type of formations.

Repeating Ship

A repeating ship is any ship through which a message is relayed. A repeating ship is any of the following:

- A ship specifically designated as a repeating ship
- A ship that automatically relays
- A ship that elects to relay to facilitate signaling
- A ship through which a message is routed

The function of a ship specifically designated as a repeating ship is to act as a primary relay station to facilitate communication.

As you can see, visual relay responsibility can be complicated; but it is a part of your job, so learn it.

OPERATOR'S RESPONSIBILITIES

Reliability, security, and speed depend, to a large extent, upon the operator. It is essential, therefore, that operators be well-trained, maintain signaling discipline, and understand thoroughly their responsibilities.

You should always follow the prescribed procedure. Unauthorized departures from or variations in prescribed procedures invariably create confusion, reduce reliability and speed, and tend to

nullify security precautions. If an unusual circumstance is not covered by set procedure, initiative and common sense should provide a reasonable procedure. The following practices are forbidden:

1. Violating visual silence when such condition is imposed.
2. Transmitting the operator's personal sign. (The operator's initials or any other identifying sign constitutes a personal sign.)
3. Using plain language when unauthorized to do so.
4. Using profane, indecent, or obscene language.
5. Using other than authorized prosigns.

VISUAL PROCEDURE

When transmitting a visual message, you must transmit each character distinctly. The speed of transmission is governed by prevailing conditions and the capability of the receiving operators.

Accuracy in transmission is far more important than speed. The difference in the time required to send a message at 10 words per minute and that required to transmit at 15 words per minute is slight. Even this slight gain in time may be nullified by an added time required for repetitions. The speed at which the receiving operator can copy without having to obtain repetitions is the speed at which the transmitting operator should transmit. When an operator is transmitting to more than one station, his/her governing speed is to be that of the slowest receiving operator. The speed of transmitting the heading should be slower than the speed of transmitting the text.

Logs and Files

Every signal transmitted or received by visual means must be logged, together with the time of execution, in a suitable record book. A file of all messages transmitted or received by visual means must be kept to facilitate future reference. Logs and files are covered more in depth in chapter 8.

Message Transmission

Messages are to be transmitted exactly as written. Abbreviations must not be substituted for plain language or plain language substituted for abbreviations.

Call Signs

The following call signs are authorized for use in calling and answering: visual, international, tactical, task organization, collective, and indefinite. Address groups may be used as call signs by Coast Guard and Navy commands (except in non-military communications.)

Call signs and address groups in message headings will ordinarily be arranged in alphabetical order in the form in which they are transmitted, whether plain, encrypted, or mixed. For this purpose, / (slant sign) and figures 0 through 9 will be considered the twenty-seventh through thirty-seventh letters of the alphabet. Care must be taken to avoid separating groups of related call signs or conjunctive address groups, which are interdependent.

The different methods of visual signaling require variations in procedure for calling and answering. The necessary instruction for each method is prescribed throughout this chapter.

FLASHING LIGHT PROCEDURES

LEARNING OBJECTIVES: Explain the procedure for calling, answering, relaying, verifying, repeating, correcting, and receiving using directional and non-directional flashing light. Identify procedures for communicating with aircraft, with daylight signaling lantern (DSL), and infrared.

The two forms of flashing light used are directional and non-directional. Directional procedure is always employed when using a directional light. It is also employed when using a non-directional light when the call is that of a single station. Non-directional procedure is one station transmitting to a number of other stations simultaneously by means of a light showing over a wide area. See appendix II for tips for sending and receiving flashing light.

USE OF SIGNAL LIGHTS

In wartime, the greatest care is to be taken when signaling at night. Flashing light is to be used only when necessary and a minimum of light employed except when making recognition signals. Then, a light of sufficient brilliancy must be used to ensure its being immediately seen. You must, however, always

remember that in heavy weather small ships have trouble reading dim lights.

The background must always be considered, and care should be taken not to use a signaling light close to or in line with navigation lights. No upper-deck lighting should be visible on or in the vicinity of the signal deck.

The use of signal lights at dusk and dawn must be avoided whenever possible. If, however, their use is unavoidable, you must pay constant attention to the brilliancy of their light.

At night, a constant watch is to be kept on the ship of the OTC by all other ships. It may be found, after communication has been established, that the brilliancy of the light can still be further reduced. It is absolutely essential when using any type of directional light to keep it trained accurately throughout the transmission of the message.

At all times, ships are to inform other ships signaling to them when their lights are observed to be brighter than necessary, by use of the prosign D. Frequently test sight arrangements of lights for alignment. To prevent masthead and yardarm signaling lights from being accidentally lighted, the switch in the power supply line should be kept open until use of the light is actually required.

DIRECTIONAL PROCEDURE

The transmitting station waits for the receiving station to make a flash for each word, prosign, coded group, or operating signal. Should the receiving station fail to flash for the group, it will be repeated by the transmitting station until a flash is received from the receiving station. An exception to this rule is that a flash is not necessary to the prosign K when there is an immediate response to K. A flash should be made to K in the message ending when there will be a delay while checking the message to ensure its completeness.

NON-DIRECTIONAL PROCEDURE

This procedure permits one station to transmit to a number of other stations simultaneously by means of a light showing over a wide area. It is seldom used at night in wartime because of the danger of enemy interception. It may be used by day or night in circumstances where the risk is negligible. The procedure prescribed for the non-directional flashing

light differs from that laid down for the directional flashing light, as follows:

1. The call consists of a collective call sign or a number of call signs repeated until answered by all receiving stations.

2. Each receiving station answers by transmitting a continuous series of Ks until the calling station, seeing that all the receiving stations have answered, stops calling, waits a short time, then starts transmitting the message. When practicable, receiving stations should use a directional light of minimum brilliance.

3. Where repeating ships are used, they will repeat the originator's transmission word by word as received.

4. During transmission of the message, all receiving stations keep their signal lights out. Should a receiving station miss a portion of the message, that station is to request a repetition in the normal manner upon completion of the transmission. A station that is repeating the message as received but misses a portion may substitute the operating signal ZEP for the missing portion and proceed with the transmission. When the missing portion is obtained, it is transmitted in the form of a correction.

ZEP means this portion (or message) was incompletely received. Each word or group missed, which is indicated by the position of ZEP in the message, will be forwarded as soon as obtained.

5. Receiving stations, after checking, receipt for the message by making RRRR.

6. When the prosign F is used in the non-directional procedure, no ship is to make any response to this call or to receipt for the message. Ships that miss the transmission or any portions thereof may request repetitions by directional flashing light from adjacent ships. In requesting such repetitions, ships should bear in mind the danger of disclosing the tactical composition of the formation.

7. The separative sign is used between coded groups.

Where a special non-directional daylight signaling lantern (DSL) is fitted, the procedure to be used by the transmitting station is the same as prescribed for the non-directional procedure. Receiving stations answer by hoisting DESIG. Repetitions are obtained in the same manner as for the non-directional procedure. The message is receipted for by hauling down DESIG.

CALLING

When calling another station, you are responsible for certain details. In visual communications, the identity of the calling station is usually apparent, and it is necessary only to gain the attention of the station being called. Normally this is done by directing the signal light at the station and making the receiving station's call sign until answered. When it is desirable to identify the calling station, use the full call. This consists of the call sign of the station called, and when answered, the prosign DE and the call sign of the calling station. On occasion, when using the no-response procedure, it may be necessary for you to transmit the full call before or without being answered.

Examples: Abbreviated call—D15 (until answered)

Full call—D15 (until answered) DE
A22 or D15 DE A22

Collective or multiple calls may be used as required. A collective call sign consists of a single call sign representing more than one station: C Squad 2. A multiple call may consist of two or more individual or collective calls: C Squad 2 C40. Both collective and multiple calls may be followed by the prosign DE and the call sign of the calling station.

Call signs and address groups that may be used in the heading and/or ending are visual call signs from ACP 129, call signs from ACP 113, and address groups from ACP 100.

The call may serve as the address. When abbreviated calls are used, it is assumed that the message is addressed from and to the senior officer embarked. When this is not the case, use a full call or the address component.

ANSWERING AND RECEIPTING

The answer normally consists of the prosign K. The calling station may flash for the series of Ks from each unit until all units have responded. If necessary to distinguish which of several stations is being answered, the prosign K should be preceded by the call sign of the station answered.

Where more than one station is being called in the same direction or during low visibility, the answering station may need to indicate its own identity when answering. This is done by transmitting the prosign DE followed by own call sign and prosign K.

When required, a full answer, consisting of the call sign of the calling station and the prosign DE followed by the call sign of the station answering, may be used.

In the flashing light procedure when giving an immediate receipt to a message in response to the prosign K, use the prosign R singly without the ending sign K or AR.

RELAYING INSTRUCTIONS

When relaying responsibilities are automatic, relaying instructions need not be inserted in the transmission instructions.

The prosign T is to be used when signals/messages are passed through a relay when the relaying responsibilities are not automatic and the originator requires no report of delivery. The address component is mandatory. When a message is received with the prosign T standing alone in the procedure component of the heading, it means "Station called transmit this message to all addressees."

Examples: Suppose that C60 transmits a message to R55, with instructions for R55 to transmit the message to F31; in that case, the heading would be as follows:

R55 DE C60 T R 231210Z MAR 96 FM
C87 TO R55 F31 BT

Prosign T followed by a call sign in the procedure component means "Station called transmit this message to station(s) whose call follows T." Assume that C60 transmits a message to R55 with instructions for R55 to transmit the message to one of the addressees—in this instance, B62:

R55 DE C60 T B62 R 231210Z MAR 96 FM C60
TO R55 F31 B62 GR4 BT UNCLAS RETURN
HOME SOON. BT K

Prosign T both preceded and followed by call signs means "The station indicated before T is to transmit this message to the station(s) indicated immediately following T." Station C60, transmitting a message to R55 and F31, instructs R55 to transmit the message to B62:

F31 R55 DE C60 R55 T B62 R 231210Z MAR 96
FM C60 TO B62 F31 R55 GR4 BT UNCLAS
RETLURN HOME SOON. BT K

When transmission is accomplished, all addressees (B62, F31, R55) will have received the message.

The prosign L is to be used when the originator requires relaying ships to report through the chain of command when the message has been delivered.

The prosign L is not to be used in the transmission instructions of executive method messages. The prosign L must, however, be passed in to the originator by relaying ships when the text of the executive method message has reached the last ship in the chain of visual responsibility. It is not to be passed in for the executive signal nor for messages where no response procedure is used.

The prosign L must be passed to the originator by a ship that relays an emergency alarm signal to the OTC.

NOTE

Visual call signs must NOT be used in the transmission instructions or address of messages to be transmitted or relayed by other than visual means.

SPECIAL PROCEDURES

The signals listed are signals used in special circumstances. ACP 129 covers procedures for using these special signals.

- Calling an unknown station
- No-response procedure
- Double-flash procedure
- Exchanging identities with the senior officer present afloat (SOPA)
- Alarm procedure for enemy reporting
- Special visual prosign OL
- Synchronizing time

CORRECTIONS AND REPETITIONS

Errors or omissions noted by the transmitting operator are to be corrected as follows:

During transmission, the operator should transmit the error prosign, repeat the last word, group, prosign, or operating signal correctly transmitted before the error, followed by the correct word, group, prosign, or operating signal, and continue on. When transmission is completed but before a receipt is obtained, the

operator should use the appropriate prosigns to correct any portion of the message.

After transmission and after a receipt is obtained, a service or abbreviated service message should be used to send any correction.

When errors or omissions are noted by the receiving operator, corrections or repetitions are to be obtained

- before a receipt has been given by the appropriate prosign, or
- after a receipt has been given by a service or abbreviated service message.

NOTE

The prosign $\overline{\text{IMI}}$ cannot be used to request repetition after a receipt has been given.

A service or abbreviated service message used to obtain repetitions or send corrections is normally assigned a precedence equal to that of the message to which it refers.

Corrections sent without a request are preceded by the prosign C with appropriate identifying data where necessary, and transmitted in the same manner as those sent in answer to a request for repetitions, corrections, or verifications.

When repetitions of portions of a message containing the call are made, the original call must be repeated in such repetitions except when only one station was called originally.

In accomplishing the previously mentioned procedures, use the prosigns AA, AB, WA, and WB. These prosigns are used in service or abbreviated service messages in conjunction with $\overline{\text{IMI}}$, $\overline{\text{INT}}$, C, J, and some operating signals. $\overline{\text{IMI}}$ is used by communications personnel to obtain a repetition; J is used by an addressee to obtain a verification and repetition of the entire transmission.

Examples:

Message

C3 DE F5

-P-231010Z MAR 96

-FM F5

-TO C3

-INFO B3

GR9 $\overline{\text{BT}}$

SEAKY-YAMXZ-HINLP-MMIAP-Y $\overline{\text{SBOU}}$ -
QWJFD-LJGFX-VITZG- $\overline{\text{ILTVQ}}$

To request repetition of the last transmission, C3 would send:

F5 DE C3

$\overline{\text{IMI}}$ K

To request all before the text, C3 would send:

F5 DE C3

$\overline{\text{IMI}}$ AB $\overline{\text{BT}}$ K

F5 would send:

C3 DE F5

AB $\overline{\text{BT}}$ -C3 DE F5

-P-231010Z MAR 96

-FM F5

-TO C3

-INFO B3

GR9 $\overline{\text{BT}}$ K

To request repetition of all before TO, C3 would send:

F5 DE C3

$\overline{\text{IMI}}$ AB TO K

F5 would send:

C3 DE F5

AB TO

C3 DE F5

-P-231010Z MAR 96

-FM F5

-TO K

To request repetition of the eighth group, C3 would send:

F5 DE C3

$\overline{\text{IMI}}$ 8 K

F5 would send:

C3 DE F5

8-VITZG

To request repetition of the second to fifth groups, C3 would send:

F5 DE C3
 $\overline{\text{IMI}}$ 2 TO 5 K

F5 would send:

C3 DE F5
2 to 5-YAMXZ-HINLP-MMIAP-YSBOU K

To request repetition of the second and fourth to seventh groups, C3 would send:

F5 DE C3
 $\overline{\text{IMI}}$ 2-4 to 7 K

F5 would send:

C3 DE F5
2-YAMXZ-4 TO 7-MMIAP-YSBOU-QWJFD-LJGFX K

In plain language messages, portions of the text are identified as words rather than numbered groups. The prosigns WA and WB are used as appropriate.

VERIFICATIONS

During certain conditions, addressees of a message may wish to verify with the originator either the entire message or a portion of it. This can be done with the use of a service, abbreviated service, or formal message. However, only the addressee may request a verification, and the reply must be authorized by the originator. Operators are not permitted to originate a request for a verification or reply thereto.

In most cases, a message will be receipted for before the need for a verification becomes evident. In those cases where it is apparent, prior to receipting for a message, that a verification will be required, verification may be requested at once instead of first receipting for the message.

The prosign J after a call and followed by identification data, when necessary, means "Verify with the originator and repeat message or portion indicated."

Examples:
Message:
D3 DE A2
-R-211355Z MAR 96

-FM A2
-TO D3
-INFO W7
 $\overline{\text{BT}}$

CHANGE COURSE WHEN READY. DO NOT CHANGE SPEED. $\overline{\text{BT}}$ K

To request verification and repetition of the entire message, D3 would send:

A2 DE D3
J 211355Z MAR 96 K

A2 would verify the message with the originator and if correct as previously sent would repeat the entire message.

To request verification and repetition of the heading, D3 would send:

A2 DE D3
J 211355Z MAR 96 AB $\overline{\text{BT}}$ K

A2 would verify with the originator and then reply:

D3 DE A2
C 211355Z MAR 96 AB $\overline{\text{BT}}$

D3 DE A2
-R-211355Z MAR 96

-FM A2
-TO D3
-INFO W7
 $\overline{\text{BT}}$ K

EXECUTIVE METHOD

The executive method is used when it is desired to execute a signal at a certain instant; for example, to ensure that two or more units take action at the same moment. Although the executive method normally is associated with signals from a signal book, it may be used when appropriate for plain language.

There are two types of executive methods:

1. Delayed executive method
2. Immediate executive method

Tactical signals may be sent by flashing light. When the OTC uses that method, however, the

procedure for the executive method is governed by the following rules:

- Only abbreviated plaindress messages may be used with the executive method.
- Executive method messages do not carry a time group.
- A message that requires a signal of execution carries the prosign IX immediately before the first BT.
- When using the executive signal, IX (5-second flash), the IX is effectively a *stand by* and should be repeated as often as necessary to ensure that all ships have received the *stand by* and are awaiting the order to execute. The moment of execution will be the completion of the 5-second flash. In both directional and non-directional procedures, all ships repeat the IX being made to ensure the signal is ready for execution and repeat the executive signal (5-second flash) to ensure simultaneous execution.
- The executive signal IX (5-second flash) alone after a call means “Execute all unexecuted messages transmitted by this station (by the executive method) to the same call.”
- Requests for repetitions, corrections, or verifications of the texts of signals taken from a naval signal book must be for the entire text or for those portions separated by TACK. If there are more than two TACKS in any signal, further amplification by use of the nearest whole signal is required.

Delayed Executive Method

When the delayed executive method is used, receiving stations receipt for the message, and the signal of execution is made in a later transmission.

Example: C8 transmits directly to C6:

C8 makes	C6 makes
C6 (until answered)	K
<u>IX</u>	Flash
<u>BT</u>	Flash
Turn	Flash
Stbd	Flash
Four	Flash
BT	Flash
K	R
To execute the signal, C8 makes	
C6 (until answered)	K
<u>IXs</u>	<u>IXs</u>
5-second flash	5-second flash
AR	Flash

Immediate Executive Method

In the immediate executive method, the text is sent twice separated by IMI. The executive signal, IX (5-second flash), is made at the end of this transmission. As a receipt cannot be obtained before execution of the message, the use of the immediate executive method must be authorized by the officer originating the message. Directional procedure may be used with a single ship. Non-directional procedure must be employed if signaling with two or more ships at night. Immediate executive method is not normally used during daylight when signaling two or more ships unless the originating ship is fitted with DSL. It is not to be used with directional flashing light when employing no-response procedures. Examples of immediate executive signals are located in ACP 129; study these examples to better familiarize yourself with executive method procedures.

Canceling Messages

Once the executive signal has been made, a message cannot be canceled. An executive method message awaiting execution can only be canceled by a separate non-executive method message. To cancel all messages awaiting execution, the prosign NEGAT is transmitted. NEGAT preceded by a call cancels all executive method messages addressed to that call. To cancel only one message or portion of several messages awaiting execution, the prosign NEGAT must be followed by identification data, consisting of a repetition of the text that is desired to be canceled.

COMMUNICATING WITH AIRCRAFT

When communicating with aircraft, keep the following points in mind:

1. Flashing is only possible when the aircraft is occupying certain positions relative to the line of sight from the station from which the flashing is taking place. Because of the aircraft's rapid movement, the time during which it is in a favorable position for signaling is very short.
2. The signaler in the aircraft may have no one to write down the message for him/her. He/she may have to read the whole message, and write it down from memory or write down each word before sending a flash. It may, therefore, be advisable with a long message to use the double-flash procedure.

3. The aircraft should be maneuvered into a favorable position so that the signaler can have an unobstructed view for as long a period as possible.

4. Accurate training of the light by the operator at all times is most important.

Aircraft are called by the means of the prosign \overline{AA} , the unknown station. Many aircraft cannot signal by flashing light, and an answer should not always be expected. If no answer is seen, the message is to be made through at least twice; repetitions are to be preceded by the prosign \overline{IMI} . Receipt may be indicated by the aircraft rocking its wings.

INFRARED COMMUNICATIONS

Infrared communications are divided into two forms: directional and non-directional. Directional is the use of the standard searchlight fitted with the H hood. Non-directional is the use of the AN/SAT 2 system located on the yardarm.

Infrared communication between separate ships is generally directional. A station having traffic for wide distribution will normally use non-directional procedures.

The OTC may prescribe calling periods during which infrared traffic may be passed without a special signal to attract attention. For example, stations may be required to monitor for infrared signaling for 15 minutes beginning on the hour and half hour. Such instruction may be found in the operation orders, communications plan, or message traffic calling periods. At the beginning of the calling period, the OTC may transmit the appropriate operating signal and the call signs of the stations the traffic is for. Stations not included in the traffic list may secure their equipment unless they have traffic for the OTC or other units in company.

To transmit infrared traffic outside calling periods or when calling periods have not been prescribed, the stations may be alerted by the code word **NANCY HANKS** on voice radio, the appropriate signal from ATP 1, volume II, or an operating signal.

The point of train (POT) light is a steady infrared light used to assist the sender in locating the receiving station and in keeping his/her light properly trained. It is turned on to indicate that a station is communicating or is ready to communicate with infrared. It is turned off at all other times. In the event of non-directional procedure, the originator's POT lights will become its *Nancy* beacons, and the

receiving stations will be able to train their receivers on the actual transmission.

SEMAPHORE PROCEDURES

LEARNING OBJECTIVES: Explain the procedure for calling, receipting, and requesting repetitions, interruptions, and relays by semaphore. Explain procedure for transmitting, rate of signaling, and the use of numerals. List special characters and semaphore abbreviations.

Semaphore and flashing light can be used interchangeably. Semaphore is much faster and generally more secure than flashing light for short-distance transmission in clear daylight. Semaphore may be used to transmit messages to several addressees at once if the sender is in a suitable position. Because of its speed, it is better adapted for long messages than other visual methods. Semaphore can be used at night with the use of wands attached to flashlights. See appendix II for semaphore drills and procedures.

Semaphore signaling procedures are similar to those used in flashing light. The general rules of visual responsibility apply; call signs are the same; and message parts are unchanged. Because of the different equipment used, some differences in procedure do exist.

Care is to be exercised in selecting a good background from which to send a semaphore message. The better the background, the greater the signaling distance.

The characters are to be formed in the same plane as the sender's shoulders, with staffs at their full extent, forefingers along the staff. When the sender is making the front sign, the flags should be crossed in front of the body.

A distinct pause is to be made at each character according to the rate of signaling. When transmitting prosigns, operating signals, and abbreviations, make this pause of double duration. A double-duration pause is also recommended when sending coded messages.

The front sign is made at the end of each word, group, prosign, or operating signal. Where double letters occur, the arms are to be dropped to the front

sign after the first letter is made, and moved to the second letter without pausing.

NUMERALS

Numerals occurring in all components of a semaphore message must be spelled out. If it is desired that numerals be recorded as digits, they must be preceded and followed by the numeral sign except in the heading and ending, where numerals or numeral pennants are always recorded as digits.

SPECIAL CHARACTERS

The following is a list of semaphore special characters. You must know these characters to become a semaphore operator.

1. The **answering** sign is used to answer a call. If necessary, the answering sign may be preceded by a call sign to denote the station answered.

2. The **attention** sign is used as a preliminary call by semaphore and to establish communication.

3. **Front** sign.

4. The **numeral** sign is used before and after each group of numerals, or group of mixed letters and numerals in the text that are to be recorded and counted as a single group consisting of letters and digits.

5. The **separative** sign in semaphore is a special character made by sending the character II as one group. It is used to prevent mistakes in reception, which might occur if letters or figures of adjacent groups are run together.

SPECIAL SEMAPHORE ABBREVIATIONS

The abbreviation SEM may be used in calling and answering by flashing light to indicate that a semaphore message will follow or that the transmitting station is to use semaphore.

Move signs are also special semaphore abbreviations. The four move signs are as follows:

- MD—move down
- ML—move to your left, as you face me
- MR—move to your right, as you face me
- MU—move up

Move signs are used by the receiving station to direct the transmitter to move to a better transmitting position.

CALLING

A station may be called by semaphore, flashing light, or flaghoist.

Semaphore

A call by semaphore is made by transmitting the call sign of the station called or by just making the attention sign. It may be answered either by making the answering sign C by semaphore or by transmitting the prosign K by flashing light.

Flashing Light

The call for a semaphore message may be made by flashing light, in which case it is answered by flashing light. After being answered, the transmitting station then indicates a semaphore message will follow by use of the abbreviation SEM.

Flaghoist

To call by flaghoist, hoist the call sign of the station called above flag JULIETT. If the message is intended for all ships in visual range, hoist only flag JULIETT. DESIG hoisted below JULIETT indicates that a priority message awaits transmission. If it is desired to indicate a higher precedence, the appropriate precedence prosign (Z or O) may be hoisted below DESIG.

The receiving station hoists the call sign of the transmitting station above ANS at the dip; when ready to receive the transmission, the receiving station will close up ANS, and then will haul ANS down to receipt for the transmission. The ANS pennant may be used without the call when no confusion will result.

RECEIPTING

Semaphore messages are receipted for by sending the prosign R by semaphore or flashing light or by hauling down the ANSWER pennant after the transmitting station hauls down the call.

If the transmitting station has more semaphore messages to send and is using the flaghoist call, the call is dipped on completion of each message. The prosign B is made followed by the prosign K. The receiving ship dips the ANS pennant to receipt for the message sent. When the transmitting station is ready to transmit the next message, it closes up the hoist, and

the receiving station follows suit when ready to receive.

REPETITIONS

Receiving stations request repetitions only when the transmitting station completes the message. The procedure to request repetitions by semaphore is basically the same as for flashing light. Chapter 4 of ACP 129 contains procedures for receiving and giving repetitions.

INTERRUPTIONS

The transmitting station may dip the call sign of the receiving station to indicate that it is required to wait. The receiving station should then dip its answering hoist until the transmitting station again hoists the call sign close up. The transmitting station may also use the prosign AS by semaphore. The receiving station may dip the answering hoist to indicate that it is unable to receive.

RELAY

Relay procedures are basically the same as those for flashing light except that the relay station need not wait for the end of the message before beginning to relay.

EXECUTIVE METHOD

The use of the executive method by semaphore is NOT authorized.

PYROTECHNICS

LEARNING OBJECTIVES: State the meaning of *pyrotechnics* and *colored lights*. List the limitations and characteristics of each.

PYROTECHNICS

Pyrotechnic signals are contained in *Pyrotechnic Signals*, ACP 168. Pyrotechnic light, flares, and rockets for international emergency situations are found in the *International Code of Signals*, Pub 102.

The meaning of a pyrotechnic signal depends on the color rather than the type of pyrotechnic used. Limitations of pyrotechnic signals must be fully recognized by Signalmen. Following are some characteristics that serve as guidelines for using pyrotechnics:

1. Simplicity, instead of complicated color combinations, is essential. Signals composed of a

succession of pyrotechnics or a combination of colors should be avoided because there is always danger that an observer may not see the whole signal and, consequently, may misinterpret it.

2. Experiments have proved that the standard colors red, white (or yellow), and green are the only satisfactory colors under varying conditions of visibility.

3. Under certain atmospheric conditions, white signals may appear yellow. Likewise, a white signal may be mistaken for a green signal under certain humid conditions. It is easy for tracer signals to be confused with red ones. Therefore, take care when identifying these signals.

4. Pyrotechnic signals are easily copied by the enemy, either for their own purposes or to confuse their opponents. Little reliance can be placed on them unless the source or origin can be definitely identified.

5. At a distance, it is difficult to identify the exact location from which a pyrotechnic was fired. A single pyrotechnic fired by each of two separate originators may appear to an observer as two pyrotechnics fired simultaneously or in succession from one originator.

6. The originator of a pyrotechnic signal has no way of knowing whether the signal was observed by the receiver for whom it was intended. Unless the action taken by the receiver indicates receipt, the signal should be confirmed by other means of communication. Once a pyrotechnic signal has been fired, there is no method of canceling except by using a different pyrotechnic device or by some other method of communication.

7. The range of visibility for a pyrotechnic signal is variable and unreliable because it depends largely on weather conditions.

Pyrotechnic signals may be used either by day or night unless otherwise specified. Being a Signalman, you must be very familiar with pyrotechnic signals; one day you will serve as a boatcrew Signalman. One of your duties as a member of a boatcrew is identifying the different pyrotechnic signals.

SOUND SIGNALING

LEARNING OBJECTIVES: Identify procedures for transmitting, receipting, and executing sound signals. Identify limitations of sound signaling.

The International Morse Code and special signals are used for this means of communication. When transmitting by whistle, siren, fog horn, or other devices in which the length of sound can be controlled, you use a short blast to represent a dot and a long blast to represent a dash. When transmitting with a device that is struck to create sound, such as a bell, gong, or drum, use a single stroke to represent a dot and two rapid strokes to represent a dash.

No heading or ending is used in sound signaling. The text is to be made twice, separated by a pause.

LIMITATIONS

The use of sound communication is normally limited to certain specified sound signals. The ones commonly used are those prescribed for vessels in the Rules of the Road. When sound signals are used in special circumstances, care must be exercised that they do not conflict with the more commonly used signals and thereby confuse ships and stations not familiar with the special signals.

Sound signals other than those included in the Rules of the Road are not to be employed in pilotage waters and are only to be used in an emergency when short range radio is not available, or for sounding visual call signs on occasions when the OTC may wish to ascertain which ships are within hearing distance.

Sound signals may only be used by the OTC or by an individual ship having vital information for the OTC. Signals made by any ship other than the OTC are to be followed by the call sign of that ship.

RECEIPTING

When the OTC signals by sound, one ship usually is directed to repeat back or receipt for the signal. When sound is used by an individual ship, the OTC is always to receipt for the signal with that ship's call sign followed by the prosign R. The OTC may direct another ship to receipt by making that ship's call sign followed by the prosign K. The designated station receipts by making the prosign DE followed by the prosign R. No ship is to relay a sound signal.

EXECUTIVE METHOD

The executive signal consists of a 5-second blast immediately following the repetition of the text. The execute to follow sign (\overline{IX}) is not to be sent either in the text or preceding the 5-second blast. The signal is executed on termination of the 5-second blast. Ships

are not to wait for any ship that may be ordered to repeat back or receipt. When ships are ordered to repeat back, they are to include the executive signal if one has been used.

IDENTIFICATION OF SHIPS

On occasion the OTC may wish to determine which ships are within hearing distance. This may be done by the OTC sounding the appropriate signal only once.

On hearing this signal, ships are to reply by sounding their visual call signs once only as follows:

1. If addressed to one ship, immediately on hearing the signal.
2. If addressed to more than one ship, the ships will answer in alphabetical order of call signs. If no ship sounds within 30 seconds, the next ship in order is to sound.

RADIOTELEPHONE

LEARNING OBJECTIVES: Define *radiotelephone* (R/T). Describe the procedures for operating the radiotelephone and maintaining security; list precautions that should be observed when communicating by radiotelephone.

Radiotelephone (R/T) is used for voice tactical and administrative communication by ships and aircraft.

The time will come when, as a Signaller, you will need to use the R/T. Study this section to improve your ability to use voice communication procedures.

There can be certain drawbacks to using the R/T. Poor voice communications (whether because of faulty equipment, adverse atmospheric conditions, or inept performance by an operator) can create confusion, reduce reliability and speed, and adversely affect operations. It is essential that all users observe established operating procedures.

Basic guidance for voice radio communication is contained in *Communications Instructions Radiotelephone Procedures*, ACP 125. Various naval publications prescribe procedures for specific environments.

SECURITY

In the interest of security, transmission by R/T should be as short and concise as possible. All operators must be cautioned that transmission by R/T is subject to enemy interception, and care must be taken when passing information.

The following basic rules are essential to transmission security and are to be strictly enforced:

1. No transmission will be made unless it has been authorized by proper authority.
2. The following practices are forbidden:
 - Violation of radio silence
 - Unofficial conversation between operators
 - Transmitting on a direct net without permission
 - Excessive tuning and testing
 - Transmitting the operator's personal sign
 - Unauthorized use of plain language
 - Use of other than authorized prowords
 - Linkage or compromise of classified call signs and address groups by plain language disclosures or association with unclassified call signs
 - Profane, indecent, or obscene language
3. The following practices are to be avoided:
 - Use of excessive transmitting power
 - Excessive time consumed in tuning, changing frequency, or adjusting equipment
 - Transmitting at a speed beyond the capabilities of receiving operators

RADIO NET

A radio net is the organization of two or more stations in direct communication on a common channel. Usually the senior station in the circuit is net control, and it directs the operation and flow of traffic on the net. The type of net and method of operation is determined from consideration of operational factors involved.

In a free net, the net control station (NCS) authorizes stations to transmit traffic to other stations without first obtaining permission from NCS. However, the NCS is not relieved of responsibility for maintaining circuit discipline.

In a direct net, stations must obtain permission from NCS before communicating with other stations. When two or more stations have traffic to send, NCS grants permission in order of message precedence. An exception is that flash messages may be sent direct.

A net is deemed to be a free net unless otherwise ordered. To change the type of net in effect, the NCS will transmit, "This is a free net" or "This is a directed net," as appropriate.

Free and direct nets are generally associated with, but are not restricted to, administrative circuits in port. They are a means of net operation and should not be confused with specifically named circuits; for example, task group reporting net, naval gunfire control net, task group tactical/warning net.

CIRCUIT LOGS

Circuit logs are maintained, when possible, on all R/T nets or circuits. The log should show a complete record of all transmitted and received traffic and of operating conditions. The log should also include the following:

- Time of entering and leaving the circuit
- Causes of delays on the circuit
- Frequency adjustments and changes
- Unusual occurrences, such as procedures and security violation

Messages addressed to, or relayed by, the receiving station are written in full on a message blank. Only sufficient data needs to be entered in the log to identify the message (originator, time of receipt, and the date-time group). Other messages should be logged with as much detail as possible. A watch-to-watch record of circuit operators is kept, with each operator signing the log on being relieved.

No entries will be erased. Necessary changes are made by drawing a single line through the original entry and then entering the change adjacent to the lined-out entry. The operator making the change initials the correction. All entries must be legible. Abbreviations may be used, but they must be readily understood.

In connection with circuit logs, the following terms identify the requirements of different types of radio watches:

Guard—A continuous receiver watch with a transmitter ready for immediate use. A complete log is kept.

Cover—A continuous receiver watch. A transmitter is tuned and available, but not necessarily immediately. A complete log is required.

Copy—A continuous receiver watch with a complete log.

Listen—A continuous receiver watch. A complete log is optional, but all traffic of interest to own ship must be logged.

Although logs may be kept manually, automatic recording devices should be used whenever possible on circuits requiring complete logs.

PHONETIC ALPHABET

Because it is easy to confuse the sound of certain letters, such as *B* and *D*, or *C* and *Z*, letters of the alphabet are never spoken as such. Instead, their phonetic equivalents are used. See table 4-1 for the phonetic alphabet. When signals from naval signal

Table 4-1.—Phonetic Alphabet

LETTER	PHONETIC EQUIVALENT	PRONOUNCED AS
A	ALFA	Al fah
B	BRAVO	BRAH voh
C	CHARLIE	CHAR lee
D	DELTA	DELL tah
E	ECHO	ECK oh
F	FOXTROT	FOKS trot
G	GOLF	GOLF
H	HOTEL	hoh TELL
I	INDIA	IN dee ah
J	JULIETT	JEW lee ett
K	KILO	KEY loh
L	LIMA	LEE mah
M	MIKE	MIKE
N	NOVEMBER	no VEM ber
O	OSCAR	OSS cah
P	PAPA	pah PAH
Q	QUEBEC	keh BECK
R	ROMEO	ROW me oh
S	SIERRA	see AIR rah
T	TANGO	TANG oh
U	UNIFORM	YOU nee form
V	VICTOR	VIK tah
W	WHISKEY	WISS key
X	XRAY	ECKS RAY
Y	YANKEE	YANG key
Z	ZULU	ZOO loo

books are transmitted by voice radio, the voice equivalents of the flags are used.

NUMERALS

To distinguish numerals from words similarly pronounced, the proword FIGURES may be used before such numbers. Numerals are pronounced as shown in the following examples:

Numeral	Spoken As
0	ZE-RO
1	WUN
2	TOO
3	TREE
4	FOW er
5	FIFE
6	SIX
7	SEV en
8	AIT
9	NIN-ER

NUMBER	Pronounced
12	Twelve
44	Fower Fower
90	Niner Ze-ro
136	Wun Tree Six
500	Fife Ze-ro Ze-ro
1,478	Wun Fow-er Seven Ait
7,000	Seven Tou-zand
16,000	Wun Six Tou-zand
812,681	Ait Wun Too Six Ait Wun

The numeral 0 is always spoken as *zero*, never *oh*. Decimal points are spoken as *day-see-mal*.

In general, numbers are transmitted digit by digit except that exact multiples of thousands are spoken as such. However, there are special cases when the normal pronunciation is prescribed and this rule does not apply.

PROWORDS

Prowords are pronounceable words or phrases that have been assigned meaning to expedite message handling on R/T circuits. Prowords are not to be substituted for textual words.

The prowords contained in table 4-2 are authorized for general use. For R/T communication between units of different nationalities, equivalent prosigns may be used instead of prowords. When so used, they are transmitted phonetically.

GENERAL PROCEDURES

ACP 125 contains the general procedures for R/T communication. To become a good operator, you must follow these procedures and instructions. A few of the general procedures follow:

- Listen before transmitting. An unauthorized break in transmitting causes confusion and often blocks a transmission in progress.
- Speak clearly and distinctly. Both slurred syllables and clipped speech are hard to understand. A widespread error among untrained operators is the failure to emphasize vowels sufficiently.
- Speak slowly. Give the recorder a chance to get it all down. That way you save time and avoid repetitions.
- Avoid extremes of pitch. A high voice cuts through the interference best, but is shrill and unpleasant if too high. A lower pitch is easier on the ear, but is difficult to understand through background noises if it is too low.
- Be natural. Maintain a normal speaking rhythm. Group words in a natural manner. Send your message phrase by phrase instead of word by word.
- Use standard pronunciation.
- Speak in a moderately strong voice to override unavoidable background noises and prevent dropout.
- Keep correct distance between lips and microphones. A distance of about 2 inches is correct for most microphones.

There are many more general procedures that could make for better transmission. Take time to become familiar with these procedures.

Abbreviations

Dates within the text should be spoken digit by digit, and the month, in full.

Example: 19 Mar is spoken as one nine March.

Initials used alone or in conjunction with short titles are to be spoken phonetically.

Table 4-2.—Prowords

PROWORD	EXPLANATION	EQUIVALENT TO
ACKNOWLEDGE (ACK)	An instruction to the addressee that the message must be acknowledged.	ZEV
ADDRESS GROUP	The group that follows is an address group.	—
ALL AFTER	The portion of the message to which I have reference is all that which follows _____.	AA
ALL BEFORE	The portion of the message to which I have reference is all that which precedes _____.	AB
ANSWER AFTER	The station called is to answer after call sign _____ when answering transmissions.	ZGO
ASSUME CONTROL	You will assume control of this net until further notice.	ZKD
AUTHENTICATE	The station called is to reply to the challenge which follows.	INT ZNB
AUTHENTICATION IS	The transmission authentication of this message is _____.	ZNB
BREAK	I hereby indicate the separation of the text from other portions of the message.	BT
BROADCAST YOUR NET	Link the two nets under your control for automatic rebroadcast.	—
CALL SIGN	The group that follows is a call sign.	—
CLOSE DOWN	Stations are to close down when indicated. Acknowledgements are required.	ZKJ
CORRECT	You are correct, or what you have transmitted is correct.	C
CORRECTION	An error has been made in this transmission. Transmission will continue with the last word correctly transmitted ____.	EEEEEEEE
	An error has been made in this transmission (or message indicated). The correct version is ____.	C
	That which follows is a corrected version in answer to your request for verification.	C
DISREGARD THIS TRANSMISSION-OUT	This transmission is in error. Disregard it. (This proword is NOT to be used to cancel any message that has been completely transmitted and for which receipt or acknowledgment has been received.)	EEEEEEEE
DO NOT ANSWER	Stations called are not to answer this call, receipt for this message, or otherwise transmit in connection with this transmission. When this proword is employed, the transmission shall be ended with the proword OUT.	F
EXECUTE	Carry out the purpose of the message or signal to which this applies. (To be used only with the executive method.)	IX (5 sec dash)
EXECUTE TO FOLLOW	Action on the message or signal which follows is to be carried out upon receipt of the proword EXECUTE. (To be used only with the delayed executive method.)	IX
EXEMPT	The station(s) immediately following is (are) exempted from the collective call or from collective address.	XMT
FIGURES	Numerals or numbers follow.	—

Table 4-2.—Prowords—Continued

PROWORD	EXPLANATION	EQUIVALENT TO
FLASH	Precedence FLASH.	Z
FROM	The originator of this message is indicated by the address designator immediately following.	FM
GRID	The portion following is a grid reference.	—
GROUPS	This message contains the number of groups indicated by the numeral following.	GR
GROUPS NO COUNT	The groups in this message have not been counted.	GRNC
I AM ASSUMING	I am assuming control of this net until further notice.	ZKA
I AUTHENTICATE	The group that follows is the reply to your challenge to authenticate.	ZNB
IMMEDIATE	Precedence IMMEDIATE.	O
IMMEDIATE EXECUTE	Action on the message or signal following is to be carried out on receipt of the word EXECUTE. (To be used only with the immediate executive method.)	<u>IX</u>
INFO	The addressees immediately following are addressed for information.	INFO
I READ BACK	The following is my response to your instructions to read back.	—
I SAY AGAIN	I am repeating transmission or portion indicated.	<u>IMI</u>
I SPELL	I shall spell the next word phonetically.	—
I VERIFY	That which follows has been verified at your request and is repeated. (To be used only as a reply to VERIFY.)	C
MESSAGE	A message that requires recording is about to follow. (Transmitted immediately after the call. This proword is not used on nets primarily employed for conveying messages. It is intended for use when messages are passed on tactical or reporting nets.)	ZBO
MORE TO FOLLOW	Transmitting station has additional traffic for the receiving station.	B
NEGATIVE (NEGAT)	Cancel message(s) sent by the delayed executive method. (NEGAT may be used to cancel a single message or a group of messages awaiting execution.)	—
NET NOW	All stations are to net their radios on the unmodulated carrier wave that I am about to transmit.	ZRC 2
NOTHING HEARD	To be used when no reply is received from a call station.	ZGN
NUMBER	Station serial number.	NR
OUT	This is the end of my transmission to you, and no answer is required or expected.	<u>AR</u>
OVER	This is the end of my transmission to you, and a response is necessary. Go ahead, transmit.	NR
PRIORITY	Precedence PRIORITY.	P
READ BACK	Repeat this entire transmission back to me exactly as received.	G
REBROADCAST YOUR NET	Link the two nets under your control for automatic rebroadcast.	—

Table 4-2.—Prowords—Continued

PROWORD	EXPLANATION	EQUIVALENT TO
RELAY (TO)	Transmit this message to all addressees (or addressees immediately following this proword). The address component is mandatory when this proword is used.	T OR ZOF
RELAY THROUGH	Relay your message through call sign _____	ZOK
ROGER	I have received your last transmission satisfactorily.	R
ROUTINE	Precedence ROUTINE.	R
SAY AGAIN	Repeat all of your last transmission. Followed by identification data means "Repeat _____ (portion indicated)."	IMI
SEND YOUR	I am ready to receive your message, report, etc. (Used only in reply to the offer of a message, etc., on tactical or reporting nets.)	K
SERVICE	The message that follows is a SERVICE message.	SVC
SIGNALS	The groups that follow are taken from a signal book. (This proword is not used on nets primarily employed for conveying signals. It is intended for use when tactical signals are passed on non-tactical nets.)	—
SILENCE (Repeated three or more times)	Cease transmissions on this net immediately. Silence will be maintained until lifted. (Transmissions must be authenticated by use of a self-authentication system, code word, etc.)	HM HM HM
SILENCE LIFTED	Silence is lifted. (Transmissions must be authenticated by means of a self-authentication system, code word, etc.)	ZUG HM HM HM
SPEAK SLOWER	Your transmission is too fast. Reduce speed of transmission.	QRS
STOP REBROADCASTING	Cut the automatic link between the two nets that are being rebroadcast and revert to normal working.	—
THIS IS	This transmission is from the station whose designator immediately follows.	DE
THIS IS A DIRECTED NET	From now until further notice this net is directed.	ZKB
THIS IS A FREE NET	From now until further notice this net is free.	ZUG ZKB
THROUGH ME	Relay your message through me.	ZOE
TIME	That which immediately follows is the time or date-time group of the message.	QTR
TO	The addressees immediately following are addressed for action.	TO
—TO—	The portions of the message to which I have reference is all that which appears between the groups _____ and _____.	—
UNKNOWN STATION	The identity of the station with whom I am attempting to establish communication is unknown.	AA
USE ABBREVIATED CALL SIGNS	Call signs are to be abbreviated until further notice.	—
USE ABBREVIATED PROCEDURE	As conditions are normal, all stations are to use abbreviated procedure until further notice.	—
USE FULL CALL SIGNS	Call signs are to be sent in full until further notice.	—

Table 4-2.-Prowords—Continued

PROWORD	EXPLANATION	EQUIVALENT TO
USE FULL PROCEDURE	As conditions are not normal, all stations are to use full procedure until further notice.	—
VERIFY	Verify entire message (or portion indicated) with the originator and send correct version. (To be used only at the discretion of, or by, the addressee to which the questioned message was directed.)	J
WAIT	I must pause for a few seconds.	AS
WAIT-OUT	I must pause longer than a few seconds.	AS AR
WILCO	I have received your signal, understand it, and will comply. To be used only by the addressee. Since the meaning of ROGER is included in that of WILCO, the two prowords are never used together.	—
WORD AFTER	The word of the message to which I have reference is that which follows _____ .	WA
WORD BEFORE	The word of the message to which I have reference is that which precedes _____ .	WB
WORDS TWICE	Communication is difficult. Transmit each phrase (or each code group) twice. (This proword may be used as an order, request, or as information.)	QSZ
WRONG	Your last transmission was incorrect. The correct version is _____ .	ZWF

Example: ACP is spoken phonetically as Alfa Charlie Papa.

Personal initials are spoken phonetically prefixed by the word INITIALS.

Example: W.C. Williams is spoken as INITIALS Whiskey Charlie Williams.

Abbreviations frequently used in normal speech may be used in the same manner when transmitted by voice radio.

Example: USS *Forrestal* may be spoken as USS *Forrestal*.

Punctuation marks are pronounced as they appear in the text, with the following exceptions: PAREN/UNPAREN or OPEN BRACKETS/CLOSE BRACKETS; an oblique stroke is called SLANT; quotation marks are spoken QUOTE/UNQUOTE.

Call Signs

Voice call signs are letters, numbers, or letter/number combinations that identify commands and units of commands. These include ships, aircraft squadrons and wings, shore establishments, type commanders, and task organization components. The voice call signs change daily.

In addition to the daily changing of the call signs, JANAP 119 contains ship and other joint armed forces voice call signs. Although the pub is always kept up to date, it is not normally used. JANAP 119 provides an adequate backup system, but lacks the security needed today.

Voice calls do not provide any degree of identification security, so they should not be used over harbor common circuits. In ports not under U.S. control, international call signs will be used. In U.S.-controlled ports overseas, names of ships and abbreviations of administrative activity titles serve as voice calls. As a general rule, the USS prefix, hull number, and first name or initial of ships need not be included in the voice call unless it is essential for clarity. Even when necessary for clarity, it is unnecessary to use the phonetic equivalents for letters and initials.

Establishing Communications

The basic methods for establishing and conducting communications are defined in ACP 121. Abbreviated call signs are not to be used in establishing communication. Before conducting regular traffic over R/T circuits, you may have to make contact with the stations involved to ascertain that communication is possible.

Example:

M15B transmits:

Alfa One Six Two—THIS IS Mike One Five
Bravo—OVER

A162 answers:

Mike One Five Bravo—THIS IS Alfa One Six
Two—OVER

M15B having nothing for A162, transmits:

Alfa One Six Two—THIS IS Mike One Five
Bravo—OUT

Establishing a Net

Full call signs are used when opening a net, reopening a net, or reporting into a previously established net. Proper control by the NCS and adherence to operating rules by all stations within the net enable the net to begin and maintain an exchange of traffic with minimum delay. The NCS is also responsible for maintaining security on its net. Appropriate security guidance will be furnished by the NCS to all stations prior to establishing a net.

Example:

When ready to establish a net, the NCS transmits:

Yankee One Six Charlie—THIS IS Mike One Five
Bravo—OVER

Each subordinate station then answers the call in alphabetical order:

Mike One Five Bravo—THIS IS Alfa One Six
Two—OVER

Mike One Five Bravo—THIS IS Bravo One Nine
Eight—OVER

Mike One Five Bravo—THIS IS Delta Two Three
Four—OVER

Once the net has been established, it will normally work with abbreviated procedures and call signs. The NCS will, however, order the net to work full or with abbreviated procedures or call signs, as required by the conditions.

MESSAGES

Although R/T uses three message forms—plaindress, abbreviated plaindress, and codress—the form most used is the abbreviated

plaindress. However, the three parts are still used (heading, text, ending).

The procedures for use of the above mentioned messages are the same as for the use of the visual message.

Plaindress

A plaindress message is one in which the originator and addressee designators are indicated externally of the text. It contains all components of the basic message format (unless the call serves as the address) and must always include the precedence and date-time group. The group count will always be included when the accounting symbol is used.

Abbreviated Plaindress

Operational requirements for speed and handling may require abbreviations of plaindress headings. In such cases, any or all of the following may be omitted:

- Precedence
- Date
- Date-time group
- Groupcount

Codress

A codress message is one in which the entire address is encrypted within the text. The heading contains only information necessary to enable communications personnel to handle it properly.

Service Messages

Service and abbreviated service messages are messages used between communications personnel and pertain to any phase of traffic handling, communication facilities, or circuit conditions. See chapter 3 for more information concerning service messages.

GENERAL OPERATING PROCEDURES

The procedures for conducting radio checks, repetitions, cancellations, corrections, and verifications are contained in ACP 125; take time to study these procedures.

EXECUTIVE METHOD

The executive method is used when it is desired to execute a tactical message at a given instant; that is, to ensure that two or more units take action at the same moment. An abbreviated plaindress format is normally used for transmitting messages by the executive method. When conditions are good, it is necessary to have all stations called acknowledge receipt of tactical message. In these circumstances, only those call signs preceding the proword OVER receipt for the message. Messages sent by the executive method are never to have a time group included in the message ending. There are two executive methods:

- Delayed
- Immediate

Delayed Executive Method

A tactical message sent by the delayed executive method will carry the warning proword EXECUTE TO FOLLOW in the message instructions, immediately preceding the text. The executive signal will be sent later in the form STANDBY—EXECUTE, the latter word being the instant of execution. The text of the message being executed must be repeated prior to the transmission of the proword EXECUTE when:

1. It is a portion of, or one of, several outstanding signals; or
2. A considerable time has elapsed between the transmission of an EXECUTE TO FOLLOW message and the transmission of the executive signal.

Example:

M15B transmits:

Six Charlie—THIS IS Five Bravo—EXECUTE TO FOLLOW—Corpen Mike One One Two—OVER

All stations respond in alphabetical order to full call signs:

Six Two—ROGER—OUT

Nine Eight—ROGER—OUT

Three Four—ROGER—OUT

After a considerable period of time has elapsed M15B transmits:

Six Charlie—THIS IS Five Bravo—Corpen Mike One One Two— Standby—EXECUTE—Three Four—OVER

Three Four responds:

Three Four—ROGER—OUT

Immediate Executive Method

In cases of urgency, the executive signal may be transmitted in the final instruction element of the message. This type of message does not allow stations to obtain verifications, repetitions, acknowledgements, or cancellations before the message is executed. Messages made by the immediate executive method should be in plain language, or should be limited to basic TURN, SPEED, and CORPEN signals.

The warning proword is IMMEDIATE EXECUTE. The text is sent twice, separated by the proword I SAY AGAIN. The executive signal is sent in the final instructions.

Example:

M15B transmits:

Six Charlie—THIS IS Five Bravo—IMMEDIATE EXECUTE—BREAK—Turn Port—Tack-Speed One Four—I SAY AGAIN—Turn Port—Tack—Speed One Four—Stand by—EXECUTE—Nine Eight—Three Four—OVER

B198 and D234 transmit:

Nine Eight—ROGER—OUT

Three four—ROGER—OUT

BEADWINDOW

Beadwindow is a simple, rapid procedure for use by circuit operators to police the security of insecure voice networks. It brings to the immediate attention of operators the fact that an Essential Element of Friendly Information (EEFI) has been disclosed on the circuit. Additionally, the beadwindow report serves to alert other operators on the net of the EEFI disclosure and thus acts as an educational aid, producing increased security awareness among operators and an overall improvement in the security of insecure voice radio.

The beadwindow procedure uses a code word (beadwindow) and a number combination, which are

SUMMARY

transmitted immediately to the station disclosing an EEFI. When a station on the net transmits information listed in an EEFI, the net control operator transmits the code word *beadwindow*, followed by the number of the EEFI that has been disclosed.

Approved broad EEFIs for general use are listed in ACP 125, chapter 5. Additional specific operations and exercises may be developed and broad EEFIs expanded by individual nations or by operational commanders. The EEFI list should be posted in clear sight of the operator at all secure voice positions for rapid reference.

In this chapter you were taught how to communicate by flashing light, semaphore, radio-telephone, sound, colored lights, and pyrotechnics. You were taught general procedures; visual responsibility; how to use operating signals; how to challenge and reply; and how to call, answer, request repetitions, and acknowledge. You were taught the difference between the delayed executive method and the immediate executive method and the time when you should use each. Now it is up to you to exercise this knowledge. Practice is the key. So when you have a little extra time, pick up a pub to further broaden your knowledge.

CHAPTER 5

ALLIED FLAGHOIST PROCEDURES

A large percentage of all tactical messages received by a ship are signaled by flaghoist. Therefore, a broad knowledge of flaghoist communication procedures on the part of every Signalman is essential. As you will learn in chapter 6, flaghoist is also used for international signaling. It comes into play, for example, when your ship exchanges messages with a merchant ship under U.S. flag or otherwise; then somewhat different procedures apply than those governing exchanges of messages between Allied naval units.

Flaghoist signaling provides a rapid and accurate system of passing tactical and administrative information during daylight. Flaghoist is rapid because, by hoisting one or more flags that have a predetermined meaning, you can communicate simultaneously with all ships in company. It is accurate because addressees are required to repeat the signal, flag for flag, allowing the originator to see if addressees have read the hoist correctly. Flaghoist signaling aptly meets the provisions of security, another prime requirement of naval communications. Not only is the range limited, but the meanings of many signals are contained in a classified signal publication.

Flaghoist signaling is especially well suited to tactical signals. All vessels can read the signal at the same time, and all can take action in unison with a minimum chance of error.

To perform effectively as a Signalman, for both military and international situations, you must acquire a solid background in procedures, methods, and rules pertaining to flaghoist communications. The main purposes of this chapter are to illustrate the flags and pennants used; explain how to construct, read, raise, and lower hoists; and discuss partial contents of the *Allied Maritime Tactical Signal and Maneuvering Book*, ATP 1, volume II, from which most tactical signals are derived.

SIGNAL FLAGS AND PENNANTS

LEARNING OBJECTIVES: List the flags and pennants in a standard naval flag bag. List the phonetic name for each letter of the alphabet. Define *tackline* and state its purpose.

The standard Navy flag bag consists of 68 flags: the 26 letters of the alphabet, 10 numeral flags, 10 numeral pennants, 18 special flags and pennants, and 4 substitutes.

Each alphabet flag has the phonetic name of the letter it represents. A numeral flag takes the name of the numeral it represents; numeral pennants are used only in calls. Special flags and pennants are used in tactical maneuvers to direct changes in speed, position, formation, and course; to indicate and identify units; and for specialized purposes. Flags and pennants are spoken and written as shown in figures 5-1 and 5-2.

One good way to learn flags and pennants is to practice sketching each of them, labeling each according to its proper color or colors. When you feel you know every flag and pennant, ask someone to test you. Ask the person testing you to call at random the various letters of the alphabet, and you name and describe the corresponding flags. When you are topside, pay particular attention to flaghoists flying from other ships. Test your ability to recognize and name those flaghoists. Many flags and pennants may be learned as opposites. Number flags can be learned by color and design sequence.

In addition to the 68 flags in the bag, you have a tackline. A tackline is a length of halyard approximately 6 feet long; the exact length depends upon the size of flags in use. The tackline is transmitted and spoken as tack and is written as a dash (hyphen) "-". It is used to avoid ambiguity. It separates signals or groups of numerals that, if not separated, could convey a different meaning from that intended.

Example:

If the signal SL2 means "Prepare to receive personnel casualties," TACK would be inserted between the digit 2 and the given number of casualties: SL2 TACK 27.

TACK also is used to separate range and bearing figures. If C3 means "Investigate possible sighting," the signal might be C3 TACK 345 TACK 20, indicating the sighting at a bearing of 345 and a distance of 20 miles.

































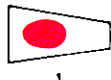

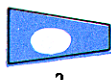

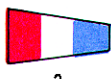
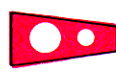



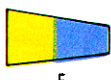

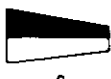
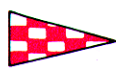
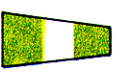
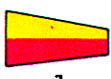
FLAG and NAME	Spoken	Written	FLAG and NAME	Spoken	Written	FLAG and NAME	Spoken	Written
 A	ALFA	A	 M	MIKE	M	 Y	YANKEE	Y
 B	BRAVO	B	 N	NOVEMBER	N	 Z	ZULU	Z
 C	CHARLIE	C	 O	OSCAR	O	 1	ONE	1
 D	DELTA	D	 P	PAPA	P	 2	TWO	2
 E	ECHO	E	 Q	QUEBEC	Q	 3	THREE	3
 F	FOXTROT	F	 R	ROMEO	R	 4	FOUR	4
 G	GOLF	G	 S	SIERRA	S	 5	FIVE	5
 H	HOTEL	H	 T	TANGO	T	 6	SIX	6
 I	INDIA	I	 U	UNIFORM	U	 7	SEVEN	7
 J	JULIETT	J	 V	VICTOR	V	 8	EIGHT	8
 K	KILO	K	 W	WHISKEY	W	 9	NINE	9
 L	LIMA	L	 X	XRAY	X	 0	ZERO	0

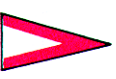
Figure 5-1.—Alphabet and numeral flags.

PENNANT and NAME	Spoken	Written	PENNANT or FLAG	Spoken	Written	PENNANT or FLAG	Spoken	Written
 1	PENNANT ONE	p1	 CODE or ANSWER	CODE or ANSWER	CODE or ANS	 NEGATIVE	NEGAT	NEGAT
 2	PENNANT TWO	p2	 SCREEN	SCREEN	SCREEN	 PREPARATIVE	PREP	PREP
 3	PENNANT THREE	p3	 CORPEN	CORPEN	CORPEN	 PORT	PORT	PORT
 4	PENNANT FOUR	p4	 DESIGNATION	DESIG	DESIG	 SPEED	SPEED	SPEED
 5	PENNANT FIVE	p5	 DIVISION	DIV	DIV	 SQUADRON	SQUAD	SQUAD
 6	PENNANT SIX	p6	 EMERGENCY	EMERGENCY	EMERG	 STARBOARD	STARBOARD	STBD
 7	PENNANT SEVEN	p7	 GROUP/ FLOTILLA	GROUP/ FLOTILLA	GROUP/ FLOTILLA	 STATION	STATION	STATION
 8	PENNANT EIGHT	p8	 FORMATION	FORMATION	FORM	 SUBDIVISION	SUBDIV	SUBDIV
 9	PENNANT NINE	p9	 INTER-ROGATIVE	INTER-ROGATIVE	INT	 TURN	TURN	TURN
 0	PENNANT ZERO	p0						
TACK LINE	TACK	—						

SUBSTITUTES					
 1st. SUBSTITUTE	FIRST SUB	1st.	 3rd. SUBSTITUTE	THIRD SUB	3rd.
 2nd. SUBSTITUTE	SECOND SUB	2nd.	 4th. SUBSTITUTE	FOURTH SUB	4th.

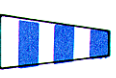
Figure 5-2.—Numeral pennants; special flags and pennants.

FLAGHOIST TERMINOLOGY

LEARNING OBJECTIVES: Explain flaghoist terminology and the use of it when communicating with flaghoist.

Every rating has its own vocabulary; the Signalmen rating is no exception. You may already be familiar with some of the terms discussed in this section.

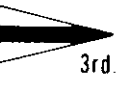
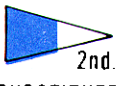
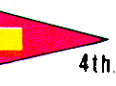
Signal flags are stowed in the flag bag. It is not actually a bag, but derives its name from the metal frame covered with canvas, in which flags formerly were stowed. Most ships today are equipped with all-metal bags, which are fireproof and afford more protection for the flags.

Halyards are numbered from outboard to inboard (1, 2, and so on). Hence, No. 1 starboard would be the outboard halyard on the starboard yardarm.

When the end of a hoist gets away from you and flies out of your reach, you can recover it by using a retriever. A retriever is a separate line attached by a metal ring to each halyard. The retriever may be moved up and down by separate lines attached as part of such rigging.

The Signalmen who keeps a lookout for signals and calls them out to personnel handling the flags at the flag bag is called the spotter. The spotter will call out, "Stand by your bags," when a signal is being made on another ship. That warning tells those personnel on the bags that a signal is being made and they should be ready to repeat it. The spotter calls out the complete hoist twice, then calls out, "Going up."

An example of an incoming signal is as follows: The spotter calls out, "Stand by your port/starboard bag. Signal in the air from the OTC. First hoist, BT—FORM 3, I say again BT—FORM 3, going up to the dip; second hoist, CORPEN STBD 275, I say again CORPEN STBD 275, going up to the dip; third hoist, SPEED 15—T13, I say again SPEED 15—T13, going up to the dip. End of hoist, end of signal."

Signal flags are bent onto the uphaul part of the halyard. The piece of halyard that is made fast to the last flag in a hoist (so the flags can be hauled down) is called the downhaul. When personnel on the bags have the downhaul secured to the last flag and are ready for the signal to be hoisted, they tell the person on the uphaul to "Take it up."

HOISTING SIGNALS

A flaghoist is said to be "closed up" when its top is touching at the point of hoist. The point of hoist is the block attached to the yardarm through which the halyard carrying the hoist is rove. It is the highest point to which the signal can be raised. Signals when hoisted by the originator are normally hoisted closed up.

A flaghoist is said to be "at the dip" when hoisted three-fourths of the way up to the point of hoist (fig. 5-3). Flaghoists made in answer to or to repeat the original signal are normally hoisted at the dip until understood; then they are hoisted close up. Relaying ships are always to repeat the flaghoist at the dip until it has been acknowledged by the ships for which they are responsible, after which they close up the signal.

A flaghoist is said to be "hauled down" when it is returned to the deck. The moment of hauling down is the moment of execution unless the time of execution is otherwise indicated. The signal is to be acted upon as soon as understood, or the signification of a signal indicates that it is to be executed on dipping.

Best results are achieved in flaghoist communication when signals can be made as a single hoist and hauled down before another signal is hoisted. If the hoist is too long (when it cannot be displayed on one halyard), it is to be broken where a tack would normally be inserted. If the entire signal cannot be made on three halyards, it is usually advisable to make two or more hoists. When this is done, the heading is hoisted and left flying close up until completion of the signals.

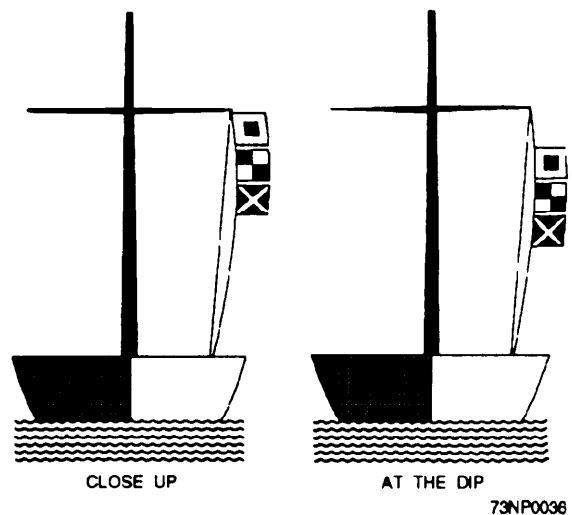

Figure 5-3.—Flaghoist close up and at the dip.

More information on the hoisting of flaghoist signals is contained in ACP 129.

READING FLAGHOISTS

It is not enough to know every flag and pennant by sight; you have to read flags in their proper sequence to interpret their meaning correctly.

When several flaghoists are displayed simultaneously, they are read in the following order: masthead, triatic stay, starboard yardarm, and port yardarm. Locations of halyards vary on ships because superstructure characteristics differ. Figure 5-4 shows the locations.

You should read flags of a single hoist from the top down. If a signal flown on a yardarm is divided into more than one hoist, read from the top down and from outboard in, as in figure 5-5. A flaghoist that is to be read before another that is flying at the same time may be described as being in a superior position. If a flaghoist is to be read after another, it is referred to as being in an inferior position.

Read flags hoisted at the triatic stay from forward to aft. (See fig. 5-6.)

FLAGHOIST ESSENTIALS

Strive for the following essentials in flaghoist signaling:

1. Always bend on the correct flag.
2. Hoist rapidly and smoothly.

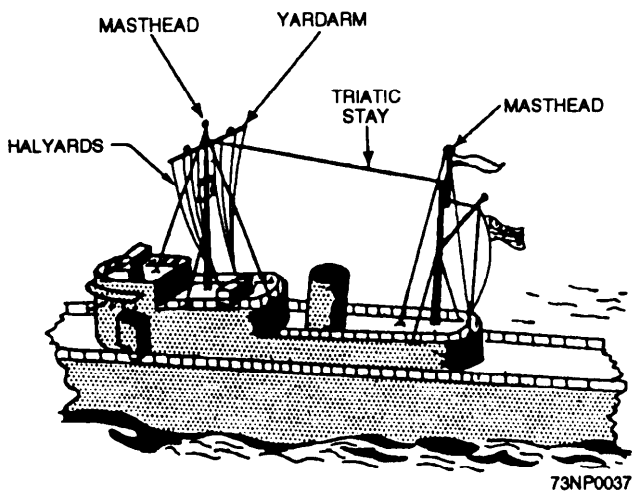

Figure 5-4.—Flaghoist locations.

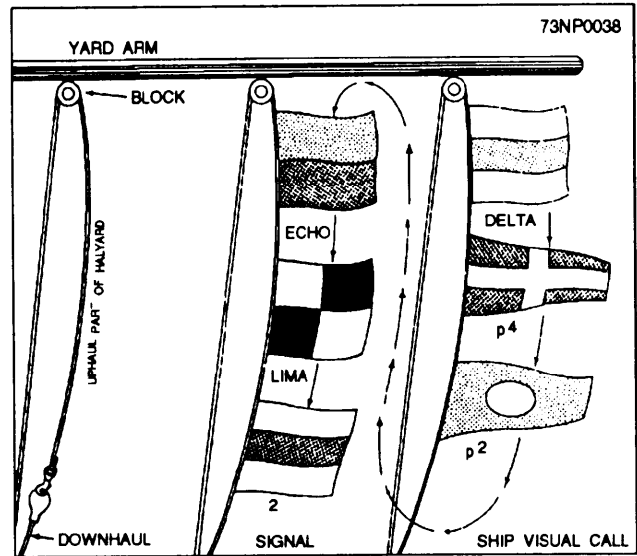

Figure 5-5.—Reading a flaghoist.

3. Send all flags up clear, unfouled by rigging or by themselves.
4. Haul down signals sharply and smoothly, without allowing them to stream to leeward or over the side.
5. Restow flags rapidly and accurately so you are ready for the next signal to be made.

FLAG BAG OPERATIONS

The day will soon come when it is your turn to stand in front of the flag bag and bend on the flags. You should know the flag bag so well that you can close your eyes and still come close to hitting the slot where a particular flag is stowed. The ability to bend

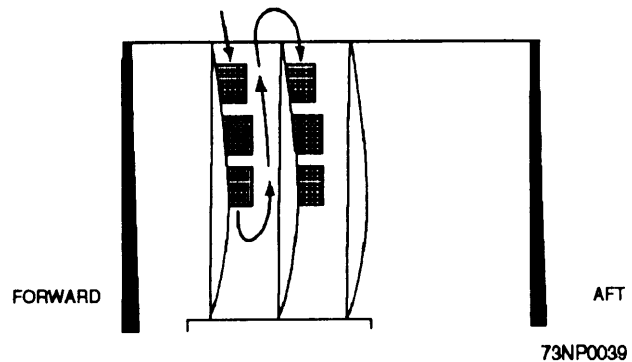

Figure 5-6.—Reading a flaghoist at the triatic stay.

on flags with accuracy and speed comes only with practice.

There are many correct ways to bend on the flags. The best way is the method that enables YOU to do the fastest and most accurate job possible. A description of one method of doing the job follows:

To bend on, lead the uphaul part of the halyard under the upper part of your right arm, with the snap on the end of the uphaul grasped firmly in your right hand. The ring on the end of the downhaul is in your left hand. (When standing by for a hoist to be called out by the spotter, you can hook the snap on the uphaul into the ring on the downhaul. This method prevents the snap from accidentally being pulled out of your hand and swinging out of reach.)

As the first flag is called out by the spotter, hook the halyard snap into the ring on the correct flag. Pull the ring out of its slot with the snap and let go. Then grasp the snap of the flag and pull it out. You are now ready to hook into the ring of the next flag. Continue this process until the spotter calls out, "Going up." Then hook the snap, which you are holding in your right hand, into the ring on the downhaul, which you have in your left hand. You are now ready to tell the person on the uphaul to "Take it up." The actual hoisting of a signal is generally a two-man job.

Be sure there is sufficient slack in the halyard to prevent the snap from pulling out of your hand. In a strong wind, put the downhaul ring over a belaying pin to free your left hand, and use both hands to handle the flags. Never make fast a halyard in use. These halyards must be free for hoisting or lowering at an instant's notice.

NOTE

All Signalmen should know the location of the emergency radar cutoff switches for their signal bridge. In the event of a lost hoist, this can prevent extensive equipment damage.

When you call out to the person on the uphaul, "Take it up," keep a slight strain on the halyard so the hoist goes almost straight up, not out with the wind. The person on the uphaul should haul away quickly and speedily, hoisting the signal to the dip or close-up position, as appropriate. PQS for flag bag operator is contained in NAVEDTRA 43354B, *Personnel Qualification Standards for Visual Communications*.

HAULING DOWN SIGNALS

When a signal is hauled down, the person on the uphaul should keep a slight strain on the halyard as you lower the hoist; otherwise, the hoist might fly out with the wind and become fouled.

Haul in quickly and evenly on the downhaul. As the ring on the downhaul comes to your hand, grasp it. Then grasp the snap on the bottom flag, and unhook it from the halyard ring. Place the downhaul ring on the belaying pin located in the fife rail on the flag bag front. Keep hauling the rest of the hoist down to the deck. As the topmost flag passes, unhook the snap end on the halyard, and hook it on the ring located on or near the flag bag.

As soon as the flags are on deck, the person on the uphaul should unsnap them one from another and hand them to you for restowing in the bag. As the flags are handed to you, the name of each flag is called out to assist you in getting them stowed. When all flags are stowed and the halyards are made ready for the next hoist, call out to the spotter, "Ready on the starboard/port bag."

PARTS OF A FLAGHOIST MESSAGE

LEARNING OBJECTIVES: Identify and explain the parts of a flaghoist message.

A flaghoist signal or message consists of two parts, heading and text. The heading may be specified by hoisting a visual call sign. Normally, a flaghoist signal or message hoisted without call signs is addressed to all units within visual contact or to the commander of the unit.

HEADING

The heading of a flaghoist message is hoisted superior to the text. That is, it is displayed in a position that is read before the text of a message. So long as the heading appears before the text, it may be flown from the yardarm on outboard hoists (as in fig. 5-5) or at the triatic stay or masthead.

Modification of Heading

The heading of a flag signal may be modified by the use of the four substitutes as follows:

FIRST SUB over the call sign of the originator hoisted where best seen means "The originator of this signal is _____." Intervening ships relay this signal

to the addressees or to the OTC if there are no addressees.

SECOND SUB in place of the address means “For general information, no specific address, no answer required.”

THIRD SUB preceding the address means “This signal, in addition to being addressed to certain ships for action, is for general information and is to be relayed and answered as an all ships signal.”

FOURTH SUB at the yardarm means “Accompanying signals are taken from ATP 2, volume II” or national or regional defense organization publications.

Construction of Heading

In constructing flaghoist calls, numerals are expressed by numeral pennants except when numeral flags are specifically indicated.

The heading consists of the address. Ordinarily, only action addressees are indicated, but information and exempted addressees may be included. Flag W and the NEGAT pennant, respectively, are used for information and exempted addressees. The address may be omitted under the following situations:

- Signals to all ships from the OTC or senior officer present afloat
- By ships addressing the OTC that are in direct visual communication with him/her and no relay is required and no confusion would result
- By ships or commands addressing emergency signals to the OTC

A tackline must often be used to separate call signs to avoid ambiguous combinations of flags in the heading. It will always be used to separate flag W from the call sign preceding and/or following it in the same hoist.

Address designations used in flaghoist messages are call signs, address groups, and sequence numbers.

Example of a heading:

ACTION—All ships

INFO—Main body

EXEMPT—Amphibious force

HOIST—p2 TACK W TACK p3 NEGAT p3p2

TEXT

The text of flaghoist messages will consist of such prescribed signals and plain language as may be necessary to convey the subject matter expressed by

the originator. Usually the message is made up of signals from the *Allied Maritime Tactical Signal and Maneuvering Book*, ATP 1, volume II, or the *International Code of Signals*, Pub 102. International signaling is discussed in chapter 6.

ALLIED MARITIME TACTICAL SIGNAL AND MANEUVERING BOOK

LEARNING OBJECTIVES: Explain the procedure for the use of the *Allied Maritime Tactical Signal and Maneuvering Book*, ATP 1, volume II, including general procedures, listing chapters, the use of the supplementary tables, single flags and pennants, substitutes, and supplementing signals. Describe procedures for encoding and decoding signals.

ATP 1, volume II, is the origin of most tactical communications between Allied naval units.

The signal book consists of instructions, tabulated sections of code, and special tables. The 34 chapters of the signal book are constituted as follows:

Chapter 1—General Instructions for Use of the Book

Chapter 2—Single Flags and Special Pennants

Chapter 3—Emergency Alarm and Action Signals

Chapters 4-9—Maneuvering Signals Using Pennants

Chapters 10-34—Two-Letter and Number-Letter Signals, Special Tables (Operational and Administrative), and Main Signal Vocabulary

The overall security classification of the signal book is NATO Restricted, but groups contained therein are a simple unchanging code and have no security. If the system of signaling is subject to interception, only unclassified information should be sent in the code. Unless specified otherwise, signals from the signal book may be used with any communication media, including flashing light, voice radio, and flaghoist.

Chapter 1 is a must for all Signalmen. It contains the general instructions for use of this publication. Take time to thoroughly study this chapter.

Signals relating to certain important types of actions are grouped in flag action tables. For instance, signals relating to ASW are located in one table. There are six flag action tables; each flag action table has a

number flag indicator assigned to it. This flag may be left flying in a superior position when successive signals from the same table are being used. Participants then may keep their books open to one table instead of searching through the book each time a signal is hoisted. This practice permits greater speed in signaling.

Supplementary tables are used primarily to expand the meaning of certain basic groups; they may be used with any governing or basic group as appropriate. When an item from the supplementary table is used by itself, it must be preceded by the basic group BV.

CONSTRUCTING FLAGHOIST SIGNALS

Words are seldom spelled out in Navy flaghoist signaling because of the length and number of hoists required and the time required to handle the hoists. The signal book provides chapter and basic groups and suffixes. A chapter group is a two-letter group allocated to a particular chapter and the main vocabulary from which all signals in that chapter are derived.

Example: CM—communication

A basic group is a signal consisting of the chapter group followed by one or more figures.

Example: CM1

Suffixes are provided so that the basic meaning can be varied. When a suffix is used, it must follow the last figure of the group, separated by a tack. The tack may be omitted if no ambiguity will arise.

Example: CM1—1, CMI—1—1

Signals from ATP 1, volume II may be supplemented or modified by the use of the following:

1. Governing pennants
2. Governing groups
3. Call signs, sequence numbers, and unit indicators
4. Description signals
5. Plain text
6. Operating signals
7. *International Code of Signals*
8. Tables

Governing Pennants

Three governing pennants—PREPARATIVE, INTERROGATIVE, and NEGATIVE—are available

to impart a different sense to a signal. When hoisted with signals, their meanings are as follows:

PREP—Prepare to

INT—Questions or inquiries

NEGAT—Cease, do not; or to give a negative sense to an otherwise affirmative (informatory) statement.

In the following examples, EX1 means “Commence run”:

PREP EX1—Prepare to commence run.

INT EX1—Are you commencing run?

NEGAT EX1—Do not commence run.

A governing pennant governs all signal groups when separated from those groups by TACK or when hoisted alone on an adjacent halyard. If the pennant is to govern only one of several signal groups, it must immediately precede the group governed. The other groups must be separated from the governed group by TACK.

Governing Groups

Governing groups are two-letter signals used in much the same fashion as governing pennants. The governing group followed by a tack, precedes the signal and governs that signal only. The governing group may be used alone when no ambiguity will result. The following list contains the governing groups:

- BA Action is being carried out (or I am)
- BB Action completed (or I have)
- BC I recommend
- BD Report time you will be ready (to _____)
- BE Report when ready (to) _____
- BF Am ready (to _____)(at _____)
- BG My present intention is to _____
- BH Request permission to _____
- BI Action is not being carried out (or I am not)
- BJ If you desire
- BK When you desire
- BL When ready
- BM Enemy/opponent is or I am being _____
- BT For use see ATP 1, volume II (articles 164e and 164g)
- BU Unable to _____
- BV Take action or information as indicated from appropriate supplementary table (ATP 1, volume II, chapter 33)
- BX Indicates end of series of groups governed by governing groups
- BZ Well done

Example:

If a junior commanding officer requests permission to proceed on duties assigned by signaling BH TACK the signal, his/her superior would reply C, signifying "Permission granted to proceed on duties assigned".

When the governing group applies to two or more signals following it, BX is inserted after the last of the signals to which it is to apply.

Call Signs, Sequence Numbers, and Unit Indicators

Call signs, address groups, and sequence numbers may be used in conjunction with groups from ATP 1, volume II to complete, amplify, or vary the meaning of the signal. Generally, call signs used to indicate ships, units, or commanders referred to in the meaning of the signal, follow the entire signal. An exception is those signals indicating bearing and distance from a unit, where the call sign appears within the signal.

A unit indicator (GROUP/FLOT, SQUAD, DIV, SUBDIV) following a signal indicates the unit carrying out the meaning of the signal.

Description Signals

A description signal, used to supplement a signal group, normally describes own or enemy forces or conveys other information. A description signal consists of DESIG, followed by numerals, letters, or groups necessary to amplify the meaning of the signal. For example, a flaghoist reporting the sighting of enemy forces might be supplemented by DESIG 2C, which would indicate the forces were composed of two light cruisers.

Plain Language

When appropriate, DESIG followed by letters and/or numerals indicates that such a group is to be interpreted literally. DESIG is to immediately precede the group to be interpreted, and only that group. When more than one group is to be governed, DESIG separated by TACK will govern those groups. Exceptions are when a plain number must be used to complete the meaning of a signal or when used in the meaning of a signal.

Words may be spelled out within the text of a signal to complete or modify the meaning. For

example, to spell out the word *yes*, the hoist would be as follows:

DESIG pennant

YANKEE flag

ECHO flag

SIERRA flag

Because spelling out words requires a number of flags, plain text is never used in flaghoist signals when the same information can be conveyed by code.

Operating Signals

The Q and Z communication operating signals contained in ACP 131 may be used alone or to supplement groups in ATP 1, volume II.

International Code of Signals

Signals contained in *International Code of Signals*, Pub 102, may be used alone or in conjunction with signal groups from ATP 1, volume II. Whenever international groups are used alone in flaghoist, international procedure is to be used in answering. Whenever military use is made of *International Code of Signals*, groups will be preceded by CODE when transmitting by flaghoist, or by INTERCO by Morse, voice, or semaphore.

When communicating with non-military ships or station or non-Allied warships, refer to *International Code of Signals*.

Tables

The supplementary tables are located in chapter 33 of ATP 1, volume II. These tables are primarily intended to expand the meaning of certain basic groups, but they can be used with any signal within the volume. When adding an item from the supplementary tables to the basic group, the table identifying letter must follow the item number. When a signal from the supplementary tables is used by itself, it will be preceded by the governing group BV except for the supplementary table X, where it may be preceded by the second substitute. Numeral flags 1 through 9 are not to be used with the supplementary table.

BASIC MANEUVERING FLAGS

Navy signal flags and pennants include six that pertain directly to maneuvering: CORPEN, FORMATION, SPEED, STATION, SCREEN, and

TURN. Signals using these basic maneuvering flags are called maneuvering signals.

A complete maneuvering signal contains one or more maneuvering flags and pennants, followed or preceded by numeral flags. Three numeral flags indicate a true course or a true bearing, depending upon the maneuvering flag or pennant with which they are displayed. When fewer than three flags are hoisted, they indicate a relative change of course or bearing in 10-degree units. The ANSWER pennant indicates half units, 5-degree increments, a fraction (1/2), or a decimal point. If the OTC desires to send a signal for a change of speed to 16.5 knots, for example, the Signalmen would hoist SPEED ONE SIX ANS. For a speed of 12.7 knots, however, they would hoist SPEED ONE TWO ANS SEVEN.

The CORPEN pennant is spoken, written, and transmitted CORPEN. It is used to change the course of ships in succession (known as column movement or wheeling) or, with a modifier, to indicate a course of a ship formation. When CORPEN is used to alter course by wheeling in a relative direction from dead ahead, it precedes the PORT flag or STARBOARD pennant and one or two numeral flags, which indicate the number of tens of degrees; three numeral flags would indicate the course on which to steady.

Examples:

CORPEN STBD 9—Alter course by wheeling to starboard 90 degrees

CORPEN PORT 090—Alter course by wheeling to port to course 090 degrees

CORPEN PORT 4 ANS—Alter course by wheeling to port 45 degrees

The TURN pennant, spoken, written, and transmitted TURN, may be used in any formation. It requires that all addressees put over their rudders simultaneously when the execute signal is given. Interpretation of these signals is always a turn together to starboard or to port.

The direction and specified amount of the turn must be indicated. TURN precedes the PORT flag or STARBOARD pennant and one or two numeral flags that indicate the amount of degrees of the turn in tens of degrees relative to the present course; three numeral flags indicate the course on which to steady.

Examples:

TURN STBD9—Ships turn together to starboard 90 degrees

TURN PORT 270—Ships turn together to port to course 270 degrees

TURN STBD 1 ANS—Ships turn together to starboard 15 degrees

The FORMATION pennant, spoken FORMATION but written and transmitted FORM, is used to assemble ships in a formation or to change a formation. The most common use of a FORM signal is to order a group of ships to arrange or rearrange themselves on an indicated line of bearing from the guide. When the desired direction is true, the usual three numeral flags are hoisted. When indicated bearing is relative, inclusion of the PORT flag or STARBOARD pennant determines whether the line of bearing is to the right or left of the guide.

Examples:

FORM 225—Ships are to form on true bearing of 225° from guide.

FORM PORT 9—Ships are to form on relative bearing indicated in tens of degrees from guide (in this instance, 090° relative to port side of the guide).

Relative bearings are always 000° to 359° clockwise around the ship. For purposes of forming up, however, these bearings run only to 180°—bow to stern—and may be on either side of the ship. A good reason for that is there are a number of standard form signals consisting simply of FORM and a number. For instance, FORM 9 without a direction pennant means “Form divisions in line abreast to starboard, division guides bearing astern,” a signal entirely different from FORM PORT 9.

Although execution of a FORM signal may require a change of course to carry out the maneuver, the final course always is the same as the original course. The only element that changes is the maneuvering ship's position relative to the guide.

The STATION pennant—spoken, written, and transmitted STATION—is used mainly to assign position or station to a ship or unit that is joining another ship or unit, or to move a ship or unit from one station to another. When accompanied by a distance or interval signal, the pennant indicates the distance a ship or unit is to be stationed from the guide or from the ship indicated in the signal.

When accompanying a ship's call sign, STATION alone directs that ship to take its proper and assigned station.

The SCREEN pennant is spoken, written, and transmitted SCREEN. It is used in signaling various screening situations.

SUBSTITUTES

Whenever possible, substitutes are used to prevent alphabet flags, numeral flags, or numeral pennants from appearing more than once in the same hoist. As their names imply, they are substitutes for other flags or pennants used in the hoist.

FIRST SUB repeats the first flag or pennant in the hoist.

SECOND SUB repeats the second flag or pennant in the hoist.

THIRD SUB repeats the third flag or pennant in the hoist.

FOURTH SUB repeats the fourth flag or pennant in the hoist.

To illustrate, the signal CORPEN PORT ZERO ZERO ZERO would read CORPEN PORT ZERO 3rd 4th.

THIRD SUB repeats the third flag, and FOURTH SUB repeats the fourth flag, which already repeats ZERO.

When more than one halyard is used to hoist a signal, each hoist is considered separately as regards substitutes. When a tackline separates hoist components, it is disregarded in the substitute count.

Substitutes also are used as “absence indicators” when a ship is not under way. This is discussed in chapter 10, “Honors and Ceremonies.”

UNITS OF REFERENCE

When a signal makes reference to numbers, distances, ranges, heights, depths, speeds, or weights, the unit of reference is as indicated (see fig. 5-7) unless otherwise stated in the meaning of the signal. However, for clarity, the units of reference are stated against some groups using the standard units, which otherwise would not need such a statement.

SIGNALING TIMES AND DATES

When the originator desires to have a signal executed at a specific time instead of when the signal is hauled down, the time indicator, TANGO flag, is used.

In the text of signals, times are expressed as four numerals; the first two denote the hours (00-23) and

Altitude	hundreds of feet
Distance	nautical miles (2,000 yards)
Range	hundreds of yards
Height	feet
Depth	feet
speed	knots
Weight	tons (2,000 pounds)
Sector boundaries	tens of degrees
Sector limits	thousands of yards

Figure 5-7.—Reference units of measurement.

the second two the minutes. ANSWER, instead of the last two figures of a time signal, may be used to express 30 minutes. Thus, 1630 is sent as 16 ANS.

Date-time groups in the text of signals are expressed as six numerals plus the zone indicator; the first set of two numerals denotes the date, the second set the hour, and the third set the minutes. When unable to make this display in one hoist, you may break it between the date and the time group.

When time is sent together with a signal group, TANGO has the following meanings:

T preceding numerals—Action will commence at that time.

T following numerals—Action will be completed by that time.

T between numeral groups—Time by which action is to be completed and time at which action is to commence, respectively.

CO2 means “Assume command.”

Examples:

CO2 TACK T1845—Commence assuming command at 1845.

CO2 TACK 1845T—Complete assuming command by 1845.

CO2 TACK 19T1845—Commence assuming command at 1845; complete assuming by 1900.

When time is referred to in the meaning of the signal group, the flag indicator TANGO may be omitted, provided no confusion results.

A time signal applies only to the group immediately preceding it. If signaled time applies to more than one group, flags BRAVO TANGO (BT) are

inserted before the first of the groups to which the time signal applies.

NEGAT over a time signal cancels all signals governed by that time signal.

BRAVO TANGO separated from the remainder of the hoist or display indicates that all signals between BT and the time group are governed by the time group. Thus, as shown in the following display:

FORM3—CORPEN STBD275—SPEED15—T13,

FORM 3 and CORPEN STBD 275 are to be executed when hauled down, but speed 15 will be carried out at 1300. To make the signaled time apply to the entire display, the display would read as follows:

BT—FORM 3—CORPEN STBD 275—SPEED 15—T13

When BT is flown separately as the first hoist and left flying during several succeeding displays, all signals made during that period will be executed when BT is hauled down. No time signal is needed with that method of execution.

TIME ZONE INDICATORS

All time signaled in ATP 1, volume II refer to GMT unless otherwise indicated; suffixes, therefore, are not required except to indicate the exception (see fig. 5-8).

ZONE		DESCRIPTION	DESIGNATION LETTERS
7 1/2W	to 7 1/2E	0	Z
7 1/2E	to 22 1/2E	-1	A
22 1/2E	to 37 1/2E	-2	B
37 1/2E	to 52 1/2E	-3	C
52 1/2E	to 67 1/2E	-4	D
67 1/2E	to 82 1/2E	-5	E
82 1/2E	to 97 1/2E	-6	F
97 1/2E	to 112 1/2E	-7	G
112 1/2E	to 127 1/2E	-8	H
127 1/2E	to 142 1/2E	-9	I
142 1/2E	to 157 1/2E	-10	K
157 1/2E	to 172 1/2E	-11	L
172 1/2E	to 180	-12	M
7 1/2W	to 22 1/2W	+1	*N
22 1/2W	to 37 1/2W	+2	O
37 1/2W	to 52 1/2W	+3	P
52 1/2W	to 67 1/2W	+4	Q
67 1/2W	to 82 1/2W	+5	R
82 1/2W	to 97 1/2W	+6	S
97 1/2W	to 112 1/2W	+7	T
112 1/2W	to 127 1/2W	+8	U
127 1/2W	to 142 1/2W	+9	V
142 1/2W	to 157 1/2W	+10	W
157 1/2W	to 172 1/2W	+11	X
172 1/2W	to 180	+12	Y

Figure 5-8.—Time zone indicators

The letter *N* is also used for minus 13; this is provided for a ship in zone minus 12 keeping daylight saving time.

BEARING, DIRECTION, AND DISTANCE

True bearing is signaled by three numerals. Such a signal may be used in conjunction with any signal group to indicate the bearing of the subject of that group.

Relative direction may be signaled by the PORT flag or STARBOARD pennant. One or two numerals may be used to indicate the number of tens of degrees from right ahead.

Bearing and distance, unless otherwise stated, are indicated by the numeral group for bearing, followed by the position or unit indicated (if required) and the numeral group for distance in miles.

SINGLE FLAGS AND PENNANTS

Some single (including basic maneuvering) flags and pennants are in almost constant use by ships in port as well as under way. Many are used so commonly that all hands aboard ship soon know them. Whenever BRAVO is seen flying, for instance, all hands should know that flammable or explosive material is being handled and that the smoking lamp is out.

When two or more single flags or pennants are shown in the same hoist, they must be separated by TACK. Single flags or pennants may be hoisted also with groups from the signal book if separated from the group and themselves by TACK. Signals from the single flag and pennant tables are not to be preceded by EMERGENCY. Individual flags following EMERGENCY have different meanings. Example: OSCAR, when hoisted alone, means man overboard, which is certainly an emergency situation. However, EMERGENCY O has an entirely different meaning. Its meaning may be found in chapter 3 of the signal book.

Single flags also are used in international signaling; do not confuse the meanings of signals under the two procedures.

EMERGENCY SIGNALS

When an emergency exists, or when the tactical situation is such that speed is the main consideration in executing a maneuver, the originator hoists the EMERGENCY pennant as the first flag on the hoist.

Any received signal preceded by EMERGENCY is acted upon as soon as understood. The originator sounds six short blasts on the ship's whistle to call attention to the hoist and, if other than the OTC, passes the signal to the OTC by the most expeditious means authorized.

Emergency signals made by flaghoist are repeated by all ships. FIRST SUB and the originator's call sign are only used with emergency alarm signals. Emergency action signals are repeated flag for flag.

When EMERGENCY is shown with several signal groups, it governs all groups when either separated from them by TACK or hoisted in a superior position on an adjacent halyard. If EMERGENCY is required to govern only one of several groups, it immediately precedes the group to be governed.

EMERGENCY preceding a call executes all signals flying under a similar call sign as soon as understood. Used without a call, EMERGENCY executes all signals flying without a call.

FLAG HOIST PROCEDURES

LEARNING OBJECTIVES: Explain the procedures for acknowledging, answering, canceling, correcting, and relaying flaghoist signals.

ANSWERING AND ACKNOWLEDGING

In transmitting a flaghoist signal, the originator hoists the flags close up with the upper (first) flag against the block. Addressees answer the signal by repeating the hoist, flag for flag, at the dip. Heavy ships and unit commanders will always repeat flag for flag. Small ships will normally act in the same manner; but when signaling conditions warrant, they may use ANS alone or below the call of the originator if necessary to avoid confusion. A flag officer or unit commander may answer a flaghoist addressed to him/her from a ship or unit commander junior to him/her by hoisting ANS at the dip, either alone or below the originator's call. This action tells the originator that an addressee has read the signal correctly. It does not, however, mean that the addressee knows what the message says. The signal watch supervisor should assist in verifying the accuracy of incoming and outgoing signals.

An addressee keeps the hoist at the dip while the OOD and CIC compare interpretations of the signal. When the OOD, by using the term *Understood, signal understood*, or a similar phrase, orders you to

acknowledge the signal, do so by hoisting the signal close up, bearing in mind the ship's visual responsibility. This notifies the originator that your ship understands the signal and is ready to carry out any required action. When the originator lowers the hoist, haul down your hoist smartly and inform the OOD that the signal has been hauled down.

When an addressee desires to question a signal, the signal or ANS shall be kept at the dip, and the INTERROGATIVE pennant hoisted on an adjacent halyard. Normally, an address over INT will not be required when communication is only between the originator and the addressee questioning the signal. When necessary to refer to the signal of a specific originator, a call may precede INT.

NOTE

INT signals need not be acknowledged if the signal in question can be clarified, hoisted, or canceled immediately. However, when answered and brought close up on both ships, INT signals should be hauled down to free the halyards for additional signals.

In addition to the provisions for the use of the INTERROGATIVE pennant used alone, it may be amplified and used as follows:

INT 1—Signal now flying not distinguishable.

INT 2—You are repeating signal incorrectly.

INT 3—I am repeating signal incorrectly.

These signals are most effective in expediting flaghoist signaling when passed by flashing light. Once a problem has been identified, regardless of ship (be it the originator, repeating ship, or last ship in visual chain of responsibility), adherence to the procedures for canceling or correcting a hoist are of paramount importance in avoiding early execution or delay and/or confusion in the receipt of the intended signal.

Requests may be acknowledged by a senior officer by hoisting flag CHARLIE or NEGAT below the call of the ship making the request. Such signals constitute both receipt and answer.

CANCELING A SIGNAL

Flaghoist signals are canceled by the following uses of NEGAT:

When only one flag signal is flying, NEGAT hoisted on an adjacent halyard cancels the signal.

When two or more flag signals are flying under the same call, NEGAT hoisted on an adjacent halyard cancels all signals flying. If only one signal is to be canceled, it must be repeated preceded by NEGAT.

When “all ships” signals and specifically addressed signals are flying at the same time, NEGAT without a call preceding it cancels all signals without a call, and NEGAT with a call preceding it cancels all signals under a similar call. If only one signal of several signals under the same call is to be canceled, it must be repeated and preceded by NEGAT under the same call.

The canceling signal and the signal canceled are to be hauled down together when all addressees have acknowledged.

CORRECTING A SIGNAL

Flaghoist signals are corrected as follows:

An originating ship cancels the signal in question, then hoists the correct signal.

A repeating ship hoists the signal meaning “Signal is repeated incorrectly” on an adjacent halyard, then hauls down both signals. The correct signal is then hoisted.

EXPEDITING OF FLAGHOIST SIGNALING

An originating ship may pass its signal by flashing light if there is doubt that its flags can be seen clearly.

Directional or non-directional light, using proper procedure, can be used. The operating signal ZJL meaning “Hoist the following signal” can be included.

Directional

If directional procedure is used, the signal will be receipted for by light and acknowledged in the normal flaghoist manner. The executive signal need not be made by light when the signal is hauled down.

Non-directional

If non-directional procedure is used and no ship will answer, the signal may be repeated as often as necessary, with repetitions being separated by the prosign IMI. Ships will acknowledge by flaghoist. The

executive signal will be made by light as the flag signal is hauled down.

Task Organization Call Sign

If a special flaghoist task organization call sign appears in the hoist, the numeral flag will be spelled out and the numeral pennant transmitted in Morse code.

Example: Task Force 56—Six 56

Substitutes, when used as the first flag in the hoist, will be transmitted as **FIRST**, **SECOND**, **THIRD**, or **FOURTH**.

RELAYING

General relaying procedures are discussed in chapter 4. The following paragraphs contain additional instructions for flaghoist.

Signals are to be relayed by any ship in position to help do so. Whenever practicable, ships repeating the OTC's signal are to do so on halyards corresponding to his/hers.

If the OTC hauls down a signal before all ships have acknowledged, ships that have answered the signal (at the dip) hoist it close up and haul down immediately. Relaying ships are to pass the signal by light to ships for which they are responsible that have not acknowledged the signal.

Signals relayed from the OTC are relayed at the dip, then hoisted close up when the ships addressed have acknowledged. The originator is not indicated.

In relaying signals from ship to ship, the originating ship hoists **FIRST SUB** followed by her call sign, the addressees' call signs, and the text. **FIRST SUB** may be omitted if the identity of the originator will be evident to all ships within visual communication range. The relaying ship hoists **FIRST SUB** above the call sign of the originator close up, followed by the addressees' call signs and the text at the dip.

When individual ships relay signals to the OTC, the procedure is the same as for ship-to-ship relaying except that the call sign of the OTC is considered to be understood and is omitted.

MAKING UP A FLAG FOR THE BREAK

LEARNING OBJECTIVES: Explain the procedures for making up a flag for the break. List flags that should be always made up for the break.

The practice of “breaking” pre-positioned flags and pennants has been followed for many years and is a sign of a smart ship. Flags and pennants should be made up and ready for the break in the following situations:

- Man overboard
- Breakdown of the ship
- Assuming the guide
- Displaying absence indicators
- Displaying personal flags and pennants

Breaking **ROMEO**, **BRAVO**, **EMERGENCY BREAKAWAY**, and **PREP** during replenishment operations

The first two occasions, in particular, signal emergencies requiring fast action.

To make up a flag for the break, follow the steps illustrated in figure 5-9. The numbered steps correspond to the numbers under each part of the illustration.

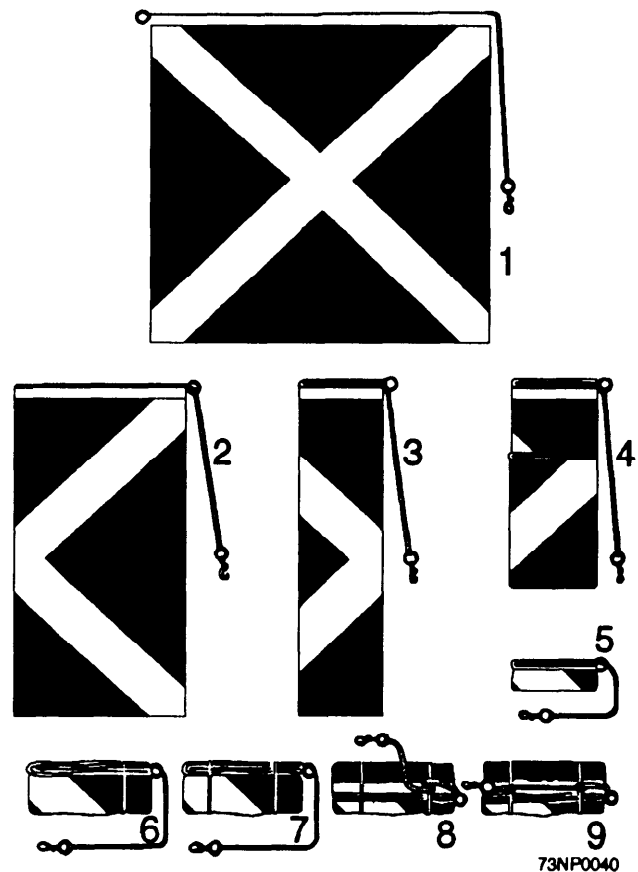

Figure 5-9.—Making up a flag for the break.

1. Usually two people hold the flag while folding it into proper form. If no one is available to assist you, lay the flag on deck, hoist end away, with the ring to your left and snap to your right.

2. Fold the flag to your right so that the left half just covers the right half.

3. Repeat step 2.

4. Fold up the fly end to a position about three-quarters of the way toward the hoist.

5. Roll the flag tightly from the fold toward the hoist.

6. About 2 inches from each end of the resulting roll, wrap two turns of white twine around the roll. Tie securely.

7. Repeat step 6.

8. With the tail line, take a full turn around the twine near the ring, repeating the operation for the twine at the other end of the roll.

9. Repeat step 8.

The flag is now ready for the break. Clear the halyard, bend on the flag, and run it up smartly. A sharp downward pull on the halyard will snap the twine and break the flag.

The national ensign is never made up for the breaking, but is always hoisted briskly and smartly.

SUMMARY

In chapter 5 you were taught flaghoist terminology, flaghoist essentials, how to read flaghoists, the parts of a flaghoist message, and how to execute flaghoist signals. You were given a brief description of the *Allied Maritime Tactical Signal and Maneuvering Book* and were taught how to answer, acknowledge, relay, receipt, and cancel a flaghoist signal. You were given the meanings of single flags and pennants and emergency signals. You were taught the basic maneuvering flags and how to use them. You were taught how to make up a flag for the break and what flags should be made up. **FLAGS**, it's up to you to put forth the effort to become the best!

CHAPTER 6

INTERNATIONAL SIGNALING

In wartime and peacetime, communications are necessary between U.S. Navy ships and merchantmen sailing throughout the world. Vessels of many nations come in contact with one another, exchanging messages of varying degrees of importance.

This chapter discusses some of the facets of international signaling, such as the manner of calling and answering, message construction, and use of procedure signals and signs. International signaling procedures are in many respects similar to those used by allied naval units. Every signalman must be aware, however, there are significant differences.

When communicating with a merchantman, you must remember to use international procedure. Merchantmen do not have access to all of our publications, nor are they required to know Navy procedure. So take a little extra time and learn how to communicate with merchantmen.

Much of the information you will need to know to communicate with merchantmen is contained in the *International Code of Signals*, Pub 102.

SIGNALING INSTRUCTIONS

LEARNING OBJECTIVES: Explain the procedure for signaling from the *International Code of Signals*, using explanation and general remarks, definitions, and general instructions. Explain the procedures for signaling using flags, flashing lights, sounds, radiotelephones, and hand flags or arms to communicate with merchantmen.

EXPLANATION AND GENERAL REMARKS

The purpose of the *International Code of Signals* is to provide ways and means of communication in situations related essentially to safety of navigation and persons, especially when language difficulties arise. In the preparation of the Code, account was taken of the fact that wide application of radiotelephony and radiotelegraphy can provide simple and effective means of communication in plain

language whenever language difficulties do not exist. The Code consists of four chapters, an appendix, and two indexes:

1. Chapter 1—Signaling Instructions
2. Chapter 2—General Signal Code
3. Chapter 3—Medical Signal Code
4. Chapter 4—Distress and Lifesaving Signals and Radiotelephone Procedures
5. Appendix—U.S./Russia Supplementary Signals for Naval Vessels
6. Indexes—Signaling Instructions and General Signal Code, and Medical Signal Code

DEFINITIONS

When a man-of-war and a merchant ship desire to communicate, it is extremely important for those involved in the use of the Code to follow the prescribed terminology. The following terms have the meanings indicated:

1. Sound signaling: Any method passing Morse signals by means of siren, whistle, foghorn, bell, or other sound apparatus.
2. Identity Signal: The group of letters and figures assigned to each station by its administration.
3. Station: A ship, aircraft, survival craft, or any place at which communications can be effected by any means.
4. Station of origin: Station where the originator submits a signal for transmission, regardless of the method of communication used.
5. Station of destination: Station in which the signal is finally received by the addressee.
6. *Receiving station*: The station by which a signal is actually being read.
7. At the dip: A hoist or signal is said to be at the dip when it is about half of the full extent of the halyards.
8. Group: Denotes more than one continuous letter and/or numeral that together compose a signal.

9. Numeral group: One or more numerals.

Definitions of the following terms agree in meaning with allied signaling instructions:

Visual signaling

Originator

Transmitting station

Addressee

Procedure

Procedure signal

Hoist

Tackline

METHODS OF SIGNALING

The methods of signaling that may be used are as follows:

Flag signaling

Flashing light signaling

Sound signaling

Voice over a loud hailer

Radiotelegraphy

Radiotelephone

Signaling by hand flags or arms

Flag Signaling

The international flagbag consist of 40 flags: 26 alphabetical flags, 10 numeral pennants, 3 substitutes, and the ANSWER pennant.

Flashing Light and Sound Signaling

The Morse symbols representing letters and numerals are signaled as in any other form of Navy communications.

In flashing light and sound signaling, it is best to err on the side of making the dots shorter in their proportion to the dashes. The distinction between the elements is then clearer. The standard rate of signaling by flashing light is 40 letters per minute.

Voice Over a Loud Hailer

Whenever possible, plain language should be used where a language difficulty exists; groups from the

International Code of Signals could be transmitted using the phonetic spelling tables.

Radiotelegraph and Radiotelephone

When radiotelegraph or radiotelephone is used for the transmission of signals, operators should comply with the *Radio Regulations of the International Telecommunications Union* in force at that time.

GENERAL INSTRUCTIONS

Unless otherwise indicated, all signals between vessels are made from the master (or commanding officer) of the vessel of origin to the captain of the vessel of destination.

Identification of Ships and Aircraft

Identity signals for ships and aircraft are allocated on an international basis. The identity signals may therefore indicate the nationality of a ship or aircraft.

Use of Identity Signals

Identity signals may be used for two purposes:

1. To speak to, or call, a station
2. To speak of, or indicate, a station

Examples:

YP LABC—I wish to communicate with vessel LABC by _____. (Complements Table 1, chapter 2, page 108)

HY 1 LABC—The vessel LABC with which I have been in collision has resumed her voyage.

Names of Vessels and/or Places

Names of vessels and/or places are spelled out, as follows:

RV GIBRALTAR—You should proceed to *Gibraltar*.

IT2 SS MICHIGAN—*SS Michigan* is on fire.

How to Signal Numbers

Numbers are signaled as follows:

Flag signaling: By the numeral pennants of the Code.

Flashing light or sound signaling: Usually by the numerals in the Morse code; they may also be spelled out.

Radiotelephone or loud hailer: By the code words of the Figure Spelling Table in chapter 1, section 10, page 18.

Figures that form part of the basic signification of a signal are to be sent together with the basic group.

Examples:

DI 20—I require boats for 20 persons.

FJ 2—Position of accident (or survival craft) is marked by sea marker.

A decimal point between numerals is to be signaled as follows:

Flag signaling: By inserting the ANSWER pennant where it is desired to express the decimal point.

Flashing light and sound signaling: By “decimal point” signal AAA.

Voice: By use of the word *decimal* (pronounced DAY-SEE-MAL).

Wherever the text allows depth to be signaled in feet or in meters, the figures should be followed by the letter *F* to indicate feet or by the letter *M* to indicate meters.

Azimuth or Bearing

Azimuth or bearing is expressed in three figures denoting degrees from 000 to 359, measured clockwise. If there is any possibility of confusion, the figures should be preceded by the letter *A*. They are always true unless expressly stated to be otherwise.

Examples:

LW 005—I received your transmission on bearing 005°.

LT A120 T1540—Your bearing from me is 120° at (local time) 1540.

Course

Course is expressed in three numerals denoting degrees from 000 to 359, measuring clockwise. If there is any possibility of confusion, the numerals should be preceded by the letter *C*. They are always true unless expressly stated to be otherwise.

Examples:

MD 025—My course is 025°.

GR C240 S18—Vessel coming to your rescue is steering course 240°, speed 18 knots.

Date

Dates are signaled by two, four, or six numerals preceded by the letter *D*. The first two numerals indicate the day of the month; when used alone, they refer to the current month.

Example:

D15—Transmitted on the 15th of the current month.

The two numerals that follow indicate the month of the year.

Example:

D1504 means 15 April.

Where necessary, the year may be indicated by two further numerals.

Example:

181096 means 18 October 1996.

Latitude

Latitude is expressed by four figures preceded by the letter *L*. The first two figures denote the degrees and the last two the minutes. The letter *N* (north) or *S* (south) follows if it is needed; however, to keep things simple, the letter may be omitted if there is no risk of confusion.

Example:

L3740S—Indicates latitude 37°40'S.

Longitude

Longitude is expressed by four or, if necessary, five figures preceded by the letter *G*. The first two (or three) figures denote the degrees and the last two the minutes. When the longitude is more than 99°, no confusion will normally arise if the figure indicating hundreds of degrees is omitted. However, where it is necessary to avoid confusion, the five figures should be used. The letter *E* (east) or *W* (west) follows if it is needed; otherwise it may be omitted, as in the case of latitude.

Example:

G13925E—Indicates longitude 139°25'E.

A signal requiring the indication of position to complete its signification should be signaled as follows:

CH L2537N G4015W—Vessel indicated is reported as requiring assistance in lat. 25°37'N long. 40°15'W.

Distance

Figures preceded by the letter *R* indicate distance in nautical miles.

Example:

OM A080 R10—Bearing and distance by radar of vessel indicated are bearing 080°, distance 10 miles.

The letter *R* may be omitted if there is no possibility of confusion.

Speed

Speed is indicated by figures preceded by

1. the letter *S* to denote speed in knots, or
2. the letter *V* to denote speed in kilometers per hour.

Examples:

BQ S300—The speed of my aircraft in relation to the surface of Earth is 300 knots.

BQ V300—The speed of my aircraft in relation to the surface of Earth is 300 kilometers per hour.

Time

Times are to be expressed in four figures, of which the first two denote the hour (from 00—midnight up to 23—11 p.m.), and the last two denote the minutes (from 00-59). The figures are preceded by

1. the letter *T*, indicating local time, or
2. the letter *Z*, indicating Greenwich mean time.

Examples:

BH T1045 L2015N G3840W C125—I sighted an aircraft at local time 1045 in lat. 20°15'N long. 38°40'W flying on course 125°.

RX Z0830—You should proceed at GMT 0830.

Time of Origin

The time of origin may be added at the end of the text. It should be given to the nearest minute and expressed by four figures. Apart from indicating the time a signal originated, it also serves as a convenient reference number.

Communication by Local Signal Codes

When a vessel or a coast station wishes to make a signal in a local code, the signal YV1—“The groups which follow are from the local code”—should precede the local signal in order to avoid misunderstanding.

FLAG SIGNALING

A man-of-war desiring to communicate with a merchant vessel will hoist the CODE pennant in a conspicuous position and keep it flying during the entire time that signals are being made. This indicates that the signal groups are from the *International Code of Signals*.

Groups from the *International Code of Signals* may also be used between allied naval ships. They may be used alone or to supplement basic signals from the *Allied Maritime Tactical Signal and Maneuvering Book*, ATP 1, volume II. Whenever military use is made of the Code, groups will be preceded by CODE when transmitted by flaghoist, or INTERCO when transmitted by Morse, voice, or hand flags. When only international signals are used, CODE/INTERCO followed by TACK are to be used as the first group to indicate that all of the following groups are taken from the Code. When used to supplement other signals, CODE/INTERCO immediately precedes the signal group to indicate that only the one group is taken from the Code. When using international signals to supplement signals from ATP 1, volume II, or when international signals are preceded by a naval call sign, naval procedure is used. Under all other circumstances, international procedure is to be used.

As a general rule, only one hoist should be displayed at a time. Each hoist or group of hoists should be kept flying until it has been answered by the receiving station. When more than one group are shown on the same halyard, they must be separated by a tackline. The transmitting station should always hoist the signal where it can be most easily seen by the receiving station; that is, in such a position that the flags will blow out clear and free from smoke.

Calling

The identity signal of the station(s) addressed is hoisted with the signal. If no identity signal is hoisted, it will be understood that the signal is addressed to all stations within visual signaling distance. If it is not possible to determine the identity signal of the station that it is desired to call, the transmitting station should hoist the group:

VF—"You should hoist your identity signal."

CS—"What is the name or identity signal of your vessel (or station)?"

At the same time, the transmitting station will hoist its own identity signal.

YQ—"I wish to communicate by... (Complements table 1, chapter 2) with vessel bearing... from me" can also be used.

Answering

All stations to which signals are addressed will hoist the answering pennant at the dip as soon as they see each hoist (the dip is defined as being one-half the full extent of the halyard). Close up immediately when the signal is understood (closed up is the full extent of the halyard). The answering pennant is returned to the dip as soon as the hoist is hauled down by the transmitting station.

How to Complete a Signal

The transmitting station hoists the answering pennant singly after the last hoist of the signal, to indicate that the signal is completed. The receiving station will answer this in the same manner as for any other signal. When the transmitting station hauls down the answering pennant, the receiving station will haul down its answering pennant at the same time.

How to Act When Signals Are Not Understood

You cannot question the meaning of a hoist by displaying the INTERROGATIVE pennant used in naval procedure. If the receiving station cannot clearly distinguish or understand the signal, it keeps the answering pennant at the dip and hoists one of the following signals:

ZK—"I cannot distinguish your signal."

ZQ—"Your signal appears incorrectly coded. You should check and repeat the whole."

ZL—"Your signal has been received but not understood."

If the originating ship hoists a wrong signal group, it cannot cancel it with the NEGAT pennant. Although international procedure does not provide for special pennants, it does have signal groups that fulfill the same purpose. In this case, for example, the originating ship would hoist the signal group

YN—"Cancel my last signal/message" or

ZP—"My last signal was incorrect. I will repeat it correctly."

Substitutes

The basic reason for using substitutes in international signaling is the same as in naval procedure: a signal flag can be repeated one or more times in the same group, while the ship may carry only one or two sets of flags. Without substitutes, for instance, it is obvious that such a group as AAA or 1000 can be made only if three sets of signal flags are available. By using up to three substitutes, any two-, three-, or four-letter group can be hoisted with only one set of flags.

The FIRST SUBSTITUTE always repeats the uppermost signal flag of that class of flags that immediately precedes the substitute.

The SECOND SUBSTITUTE always repeats the second signal flag and the THIRD SUBSTITUTE repeats the third signal flag, counting from the top of that class of flags that immediately precedes them. No substitute can ever be used more than once in the same group.

There is an important difference between the use of substitutes in naval and international procedures. As you learned in chapter 5, in naval procedure a substitute repeats ANY flag or pennant that precedes it on the base hoist. In international signaling, a substitute repeats only a flag or pennant of the same class (that is, alphabet or numeral) immediately preceding it. The signal VV, for example, would be made as follows:

V

FIRST SUBSTITUTE

The number 1100 would be made by numeral pennants as follows:

1

FIRST SUBSTITUTE

0

THIRD SUBSTITUTE

The signal L 2330 would be hoisted as follows:

L
2
3

SECOND SUBSTITUTE

0

In this case, the SECOND SUBSTITUTE follows a numeral pennant and, therefore, can only repeat the second numeral in the group.

No substitute may be used more than once in the same group. For example, the signal AABA would be

A

FIRST SUBSTITUTE

B

SECOND SUBSTITUTE

The FIRST SUBSTITUTE, used to repeat the first A, cannot be used again. But, having been used it is equivalent to having hoisted A as the second flag. Consequently, it is the second flag that is required to be repeated as the last flag of the group. Hence, the SECOND SUBSTITUTE is used.

When the ANSWER pennant is used as a decimal point, it is disregarded in determining the substitute to use.

Plain Language

Names in the text of a signal are spelled out by means of alphabet flags. The signal YZ—"The words which follow are in plain language"—can be used, if necessary.

FLASHING LIGHT SIGNALING

A signal made by a flashing light is divided into the following parts:

1. **Call**—Consists of the general call or identity signal of the station to be called. It is answered with the answering signal.
2. **Identity**—Transmitting station makes *DE* followed by its identity signal or name. This is repeated back by the receiving station, which then signals its own identity signal or name. This also is repeated back by the transmitting station.
3. **Text**—Consists of plain language or Code groups. When Code groups are to be used, they

should be preceded by the signal *YU*. Words of plain language may also be in the text when the signal includes names, places, and so on. Receipt of each word or group is acknowledged by *T*.

4. **Ending**—Consists of ending signal AR, which is answered by *R*.

If the entire text is in plain language, the same procedure is followed. Call and identity may be omitted when two stations have established communications and have already exchanged signals.

Use of Procedure Signals and Signs

The following is the list of procedure signals for flashing light transmissions.

- AA "All after..."(used after the "repeat signal" (RPT)) means "Repeat all after..."
- AB "All before..."(used after the "repeat signal" (RPT)) means "Repeat all before..."
- AR Ending signal or end of transmission or signal.
- AS Waiting signal or period.
- BN "All between...and..." (used after the "Repeat signal" (RPT)) means "Repeat all between...and..."
- C Affirmative—YES or "The significance of the previous group should be read in the affirmative."
- CS "What is the name or identity signal of your vessel (or station)?"
- DE "From..." (used to precede the name or identity signal of the calling station.)
- K "I wish to communicate with you" or "Invitation to transmit."
- NO Negative—NO or "The significance of the previous group should be read in the negative." When used in voice transmission the pronunciation should be "NO."
- OK Acknowledging a correct repetition or "It is correct."
- RQ Interrogative or "The significance of the previous group should be read as a question."
- R "Received" or "I have received your last signal."
- RPT Repeat signal "I repeat" or "Repeat what you have sent" or "Repeat what you have received."
- WA "Word or group after..."(used after the "Repeat signal" (RPT)) means "Repeat word or group after..."
- WB "Word or group before..." (used after the "Repeat signal" (RPT)) means "Repeat word or group before..."

Although the use of these signals is self-explanatory, the following notes might be found useful:

These examples illustrate the convenience of international procedure signals and signs:

1. The general call signal (or call for unknown station) *AA AA AA* is made to attract attention when wishing to signal to all stations within visual signaling distance or to a station whose name or identity signal is not known. The call is continued until the station addressed answers.
2. The answering signal *TTTT* is made to answer the call and it is continued until the transmitting station ceases to make the call. The transmission starts with the signal *DE* followed by the name or identity signal of the transmitting station.

Example: When one of the stations is other than an Allied naval ship,

STATION "A" TRANSMITS	STATION "B" TRANSMITS
AA AA (until answered)	TTTT (until call ceases)
DE NABC	DE NABC KFLN KFLN
AR	R

3. The letter *T* is used to indicate the receipt of each word or group.

4. The erase signal *EEEEEE* indicates that the last group or word was signaled incorrectly. It is answered with the erase signal. When answered, the transmitting station will repeat the last word or group that was correctly signaled and then proceed with the remainder of the transmission.

5. The repeat signal *RPT* is used as follows:

By the transmitting station to indicate that it is going to repeat ("I repeat"). If such a repetition does not follow immediately after *RPT*, the signal should be interpreted as a request to the receiving station to repeat the signal received ("Repeat what you have received").

By the receiving station to request a repetition of the signal transmitted ("Repeat what you have sent").

The special repetition signals *AA*, *AB*, *WA*, *WB*, and *BN* are made by the receiving station as appropriate. In each case, they are made immediately after the repeat signal *RPT*.

Examples:

RPT AB KL—"Repeat all before group KL."

RPT BN BOATS SURVIVORS—"Repeat all between words *boats* and *survivors*."

If a signal is not understood or, when decoded, is not intelligible, the repeat signal is not used. "The receiving station must then make the appropriate signal from the Code, indicating "Your signal has been received but not understood."

6. A correctly received repetition is acknowledged by the signal *OK*. The same signal may be used as an affirmative answer to a question ("It is correct").

7. The ending signal *AR* is used in all cases to indicate the end of a signal or the end of a transmission. The receiving station answers the signal *R*—"Received" or "I have received your last signal."

8. The transmitting station makes the signal *CS* when requesting the name or identity signal of the receiving station.

9. The waiting signal or period signal *AS* is used as follows:

- When made independently or after the end of a signal, it indicates that the other station must wait for further communications (waiting signal).

- When it is inserted between groups, it serves to separate them (period signal) to avoid confusion.

10. The signal *C* should be used to indicate an affirmative statement or an affirmative reply to an interrogative signal; the signal *RQ* should be used to indicate a question. For a negative reply to an interrogative signal or for a negative statement, the signal *N* should be used in visual or sound signaling, and the signal *NO* should be used for voice or radio transmission.

When the signals *N* or *NO* and *RQ* are used to change an affirmative signal into a negative statement or into a question, respectively, they should be transmitted after the main signal.

Examples:

CY N (or NO, as appropriate)... "Boat(s) is (are) not coming to you."

CW RQ—"Is boat/raft on board?"

The signals *C*, *N* or *NO*, and *RQ* cannot be used in conjunction with single-letter signals.

SOUND SIGNALING

Because of the apparatus used (whistle, siren, foghorn), sound signaling is necessarily slow. Moreover, the misuse of sound signaling could create

serious confusion at sea. Sound signaling in fog should, therefore, be reduced to a minimum. Signals other than the single-letter signals should be used only in extreme emergency and never in frequented navigational waters.

The signals should be made slowly and clearly. They may be repeated, if necessary, but at sufficiently long intervals to ensure that no confusion can arise and that one-letter signals cannot be mistaken for two-letter groups.

Under international procedures, a transmitting ship calls in the same manner as by flashing light; the receiving ship replies with the answering sign. (No call or answer is sent, however, when transmitting single-letter signals.) The transmitting ship then sends the entire message. Unless the receiving ship misses a word or group, it does not answer until the ending AR is made; it then indicates receipt by sending R.

If the receiving ship misses a word or group during the transmission, it immediately signals RPT to indicate the omission; the transmitting ship goes back a few words or groups, then continues the message. Ships do not exchange identities in this form of communication despite use of the general call AA.

RADIOTELEPHONE

When using the *International Code of Signals* in cases of language difficulties, the principles of the *Radio Regulations of the International Telecommunications Union* then in force have to be observed. Letters and figures are spelled out according to phonetic spelling tables. When coast and ship stations are called, the identity signals or names shall be used.

Calling

The call consists of the call sign or name of the station called, the group DE, and the call sign or name of the calling station.

Difficult names of stations should be spelled. After contact has been established, the call sign or name need not be sent again.

Answering

The reply to a call consists of the call sign of the calling station, the group DE, and the call sign or name of the station called.

General Information

When calling all stations in the vicinity, the group CQ is used.

To indicate that groups are from the *International Code of Signals*, the word INTERCO is inserted. The group YZ will be used when plain language is used in the text.

The signal AS is used when the station called is unable to receive traffic immediately.

To receipt for a transmission, the signal R is used.

Repetitions are obtained by RPT followed by prowords if needed.

To end a transmission, the signal AR is used.

MORSE SIGNALING BY HAND FLAGS OR ARMS

A station that desires to communicate with another station by Morse signaling using hand flags or arms may indicate the requirement by transmitting to that station the signal KI by any method. The call signal AA may be made instead.

On receipt of the call, the station addressed should make the answering signal or, if unable to communicate by this means, should reply with the signal YSI by any available method.

The call signal AA AA AA and the signal T should be used, respectively, by the transmitting station and the addressed station.

Normally both arms should be used for this method of transmission, but in cases where this is difficult or impossible, one arm can be used.

All signals will end with the ending signal AR.

Figure 6-1 shows positions for Morse signaling by hand flags or arms.

SINGLE-LETTER SIGNALS

International single-letter signals, which may be made by any method of signaling, have specific meanings that in most cases do not parallel the same

1 RAISING BOTH HAND FLAGS OR ARMS

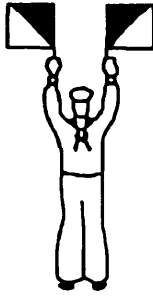

'Dot'

2 SPREADING OUT BOTH HAND FLAGS OR ARMS AT SHOULDER LEVEL

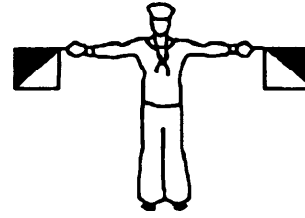

'Dash'

3 HAND FLAGS OR ARMS BROUGHT BEFORE THE CHEST



SEPARATION OF *'dots'* AND/OR *'dashes'*

4 HAND FLAGS OR ARMS KEPT AT 45° AWAY FROM THE BODY DOWNWARD

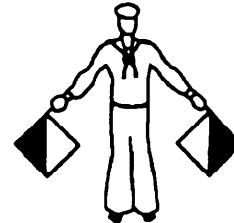

SEPARATION OF LETTERS, GROUPS OR WORDS

5 CIRCULAR MOTION OF HAND FLAGS OR ARMS OVER THE HEAD

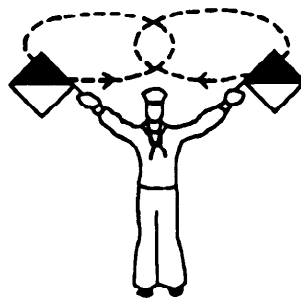

ERASE SIGNALS, IF MADE BY THE TRANSMITTING STATION.
REQUEST FOR REPETITION IF BY THE RECEIVING STATION.

73NP0041

Figure 6-1.—Morse signaling by hand flags or arms.

single-letter signals from ATP 1, volume II. These important and commonly used signals are as follows:

- A I have a diver down; keep well clear at slow speed.
- B* I am taking in, discharging, or carrying dangerous goods.
- C* Yes (Affirmative or "The significance of the previous group should be read in the affirmative.")
- D* Keep clear of me; I am maneuvering with difficulty.
- E* I am altering my course to starboard.
- F I am disabled; communicate with me.
- G* I require a pilot. When made by fishing vessels operating in close proximity on the fishing grounds, it means "I am hauling nets."
- H* I have a pilot on board.
- I* I am altering my course to port.
- J I am on fire and have dangerous cargo on board, keep well clear of me.
- K I wish to communicate with you.
- L You should stop your vessel instantly.
- M My vessel is stopped and making no way through the water.
- N NO (Negative or "The significance of the previous group should be read in the negative.") This signal may be given only visually or by sound. For voice or radio transmission, the signal should be "NO."
- O Man overboard.
- P In harbor—All persons should report on board as the vessel is about to proceed to sea. At sea—It may be used by fishing vessels to mean "My nets have come fast upon an obstruction."
- Q My vessel is "healthy" and I request free pratique.
- S* My engines are going astern.
- T* Keep clear of me; I am engaged in pair trawling.
- U You are running into danger.
- V I require assistance.
- W I require medical assistance.
- X Stop carrying out your intentions and watch for my signals.
- Y I am dragging my anchor.

Signals of letters marked by an asterisk (*), when made by sound, may only be made in compliance with the requirements of the *International Regulations for Preventing Collisions at Sea*.

Signals *K* and *S* have special meanings as landing signals for small boats with crews or persons in distress.

SINGLE-LETTER SIGNALS WITH COMPLEMENTS

These signals can be transmitted by any method of signaling. A list of the single-letter signals with complements are listed below:

AZIMUTH OR BEARING	A with three numerals
COURSE	C with three numerals
DATE	D with two, four, or six numerals
LONGITUDE	G with four or five numerals (the last two numerals denote minutes, and the rest, degrees)
COMMUNICATE (I wish to communicate with you by (complement table 1))	K with one numeral
LATITUDE	L with four numerals (the first two numerals denote degrees, and the rest, minutes)
DISTANCE in nautical miles	R with one or more numerals
SPEED in knots	S with one or more numerals
LOCAL TIME	T with four numerals (the first two numerals denote hours, and the rest, minutes)
SPEED in kilometers per hour	V with one or more numerals
GMT	Z with four numerals (the first two numerals denote hours, and the rest, minutes)

GENERAL SIGNAL CODE

LEARNING OBJECTIVES: List and explain 10 sections contained in the General Signal Code.

Each section in the General Signal Code covers specific actions. For example, section 1, Distress—Emergency, ranges from *abandon ship* to *search and rescue*; and section 3, Aids to Navigation, ranges from *course* to *water depth*. The sections and their contents are as follows:

1. DISTRESS—EMERGENCY
2. CASUALTIES—DAMAGES
3. AIDS TO NAVIGATION—NAVIGATION—HYDROGRAPHY
4. MANEUVERS

5. MISCELLANEOUS
6. METEOROLOGY—WEATHER
7. ROUTING OF SHIPS
8. COMMUNICATIONS
9. INTERNATIONAL SANITARY REGULATIONS
10. TABLE OF COMPLEMENTS

You can see that almost every situation possible is covered in the General Signal Code. This code is very important, so familiarize yourself with it.

MEDICAL SIGNAL CODE

LEARNING OBJECTIVES: Explain procedures for encoding and decoding medical signals. List procedures for instructions to Masters and Doctors.

Chapter 3 of the *International Code of Signals* covers the Medical Signal Code. This code is divided into the four following sections:

1. Explanations and Instructions
2. Request for Medical Assistance
3. Medical Advice
4. Table of Complements

Medical advice should be sought and given in plain language whenever possible, but if language difficulties arise, the Code should be used.

Even when plain language is used, the text of the Code and the instructions should be followed as far as possible.

Reference is made to the procedure signals C, N or *NO*, and *RQ*, which when used after the main signal, change its meaning into affirmative, negative, and interrogative, respectively.

Example:

MFE RQ—Is bleeding severe?

MFE N—Bleeding is not severe.

INSTRUCTIONS TO MASTERS

The master should make a careful examination of the patient and should try to collect, as far as possible, information covering the following subjects (under chapter 3 of the Code):

1. Description of the patient
2. Previous health
3. Localization of symptoms, diseases, or injuries
4. General symptoms
5. Particular symptoms
6. Diagnosis

Such information should be coded by choosing the appropriate groups from the corresponding sections of the Code. It would help the recipients of the signal if the information were transmitted in the order shown in the previous list.

After a reply from the doctor has been received and the instructions therein followed, the master can give a progress report by using signals from chapter 3.

INSTRUCTIONS TO DOCTORS

Additional information can be requested by using chapter 3, section 3A.

Example:

MQB—I cannot understand your signal. Please use standard method of case description.

For diagnosis, chapter 3, section 3B should be used

Example:

MQE 26—My probable diagnosis is cystitis.

Prescribing should be limited to the “List of Medicaments” which comprises table M-3 in chapter 3, section 4.

For special treatment, signals from chapter 3, section 3C should be used.

Example:

MRP 4—Apply ice-cold compress and renew every 4 hours.

When prescribing medication, three signals found in chapter 3, section D, should be used as follows:

1. The first (chapter 3, section 3D-1 and table M-3 in chapter 3, section 4) signifies the medication itself.

Example:

MTD 32—You should give aspirin tablets.

2. The second (chapter 3, section 3D-2) signifies the method of administration and dose.

Example:

MTI 2—You should give by mouth two tablets/capsules.

3. The third (chapter 3, section 3D-3) signifies the frequency of the dose.

Example:

MTQ 8—You should repeat every 8 hours.

The frequency of external applications is coded in chapter 3, section 3D-4.

Example:

MTU 4—You should apply every 4 hours.

Advice concerning diet can be given by using signals from chapter 3, section 3E.

Example:

MUC—Give water only in small quantities.

As an example, two cases of request for assistance and the corresponding replies follow:

CASE ONE

REQUEST FOR MEDICAL ASSISTANCE. “I have a male age 44 years. Patient has been ill for 2 days. Patient has suffered from acute bronchitis. Onset was sudden. Patient is delirious. Patient has fits of shivering. Temperature taken in mouth is 40°C. Pulse rate per minute is 110. The rate of breathing per minute is 30. Patient is in pain (chest). Part of the body affected is right (chest). Pain is increased on breathing. Patient has severe cough. Patient has bloodstained sputum. Patient has been given penicillin injections without effect. Patient has received medication in last 18 hours. My probable diagnosis is pneumonia.”

MEDICAL ADVICE. “Your diagnosis is probably right. You should continue giving penicillin injections. You should repeat every 12 hours. Put patient to bed lying down at absolute rest. Keep patient warm. Give fluid diet, milk, fruit juice, tea, mineral water. Give water very freely. Refer back to me in 24 hours, or before if patient worsens.”

CASE TWO

REQUEST FOR MEDICAL ASSISTANCE. “I have a male aged 31 years. Patient has been ill for 3 hours. Patient has had no serious previous illness. Pulse rate per minute is 95. Pulse is weak. Patient is

sweating. Patient is in pain in lumbar (kidney) region. The part affected is left lumbar (kidney) region. Pain is severe. Pain is increased by hand pressure. Bowels are regular.”

REQUEST FOR ADDITIONAL INFORMATION. “I cannot make a diagnosis. Please answer the following questions. Temperature taken in the mouth is (number). Pain radiates to groin and testicle. Patient has pain on passing water. Urinary functions normal. Vomiting is present.”

ADDITIONAL INFORMATION. “Temperature taken in mouth is 37°C. Pain radiates to groin and testicle. Patient has pain on passing water. Patient is passing small quantities of urine frequently. Vomiting is absent. Patient has nausea.”

MEDICAL ADVICE. “My probable diagnosis is kidney stone (renal colic). You should give morphine injection. You should give by subcutaneous injection 15 milligrams. Give water freely. Apply hot water bottle to lumbar (kidney) region. Patient should be seen by doctor when next in port.”

DISTRESS AND LIFESAVING SIGNALS

LEARNING OBJECTIVES: List and define distress and lifesaving signals. Explain distress transmitting procedures.

Chapter 4 of the *International Code of Signals* covers distress signals, lifesaving signals, and distress radiotelephone transmitting procedures.

DISTRESS/LIFESAVING













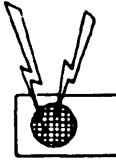

The following signals, to be used or displayed either together or separately, indicate distress and need of assistance (see fig. 6-2):

A gun or other explosive signal fired at intervals of about a minute

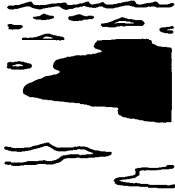
A continuous sounding with any fog-signaling apparatus

Rockets or shells, throwing red stars fired one at a time at short intervals

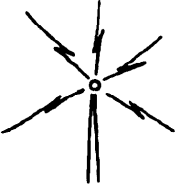
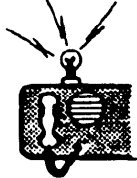
A signal made by radiotelegraphy or by any other signaling method consisting of the group ...----- (SOS) in the Morse code

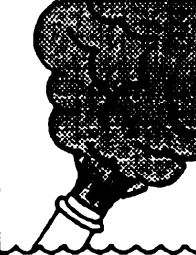
			
RED STAR SHELLS	FOG HORN CONTINUOUS SOUNDING	FLAMES ON A VESSEL	GUN FIRED AT INTERVALS OF 1 MIN.
	SOS  SOS		
ORANGE BACKGROUND BLACK BALL AND SQUARE		"MAYDAY" BY RADIO	PARACHUTE RED FLARE
			
DYE MARKER (ANY COLOR)	CODE FLAGS NOVEMBER CHARLIE	SQUARE FLAG AND BALL	WAVE ARMS
			
RADIO-TELEGRAPH ALARM	RADIO-TELEPHONE ALARM	POSITION INDICATING RADIO BEACON	SMOKE

73NP0042

Figure 6-2.—Distress signals.

A signal sent by radiotelephony consisting of the spoken word "Mayday"

The international code signal of distress indicated by NC

A signal consisting of a square flag having above or below it a ball or anything resembling a ball

Flames on the vessel (as from a burning tar barrel, oil barrel, and so forth.)

A rocket parachute flare or a hand flare showing a red light

A smoke signal giving off orange-colored smoke

Slowly and repeatedly raising and lowering arms outstretched to each side

The radiotelegraph alarm signal

The radiotelephone alarm signal

Signals transmitted by emergency position-indicating radio beacons

Vessels in distress may use the radiotelegraph alarm signal or the radiotelephone alarm signal to secure attention to distress calls and messages. The radiotelegraph alarm signal, which is designed to actuate the radiotelegraph auto alarms of vessels so fitted, consists of a series of 12 dashes sent in 1 minute.

The duration of each dash is 4 seconds, and the duration of the interval between two consecutive dashes is 1 second. The radiotelephone alarm signal consists of two tones transmitted alternately over periods of from 30 seconds to 1 minute.

The use of any of the foregoing signals except for the purpose of indicating that a vessel or seaplane is in distress, and the use of other signals that may be confused with any of the previously mentioned signals are prohibited.

Attention is drawn to the relevant sections of the *Merchant Ship Search and Rescue Manual*, and the following signals:

- A piece of orange-colored canvas with either a black square and circle or other appropriate symbol (for identification from the air)
- A dye marker

Signals used in situations of distress and search and rescue are shown in figure 6-2 (Distress) and figure 6-3 (Lifesaving signals).



























I Landing signals for the guidance of small boats with crews or persons in distress				
	MANUAL SIGNALS	LIGHT SIGNALS	OTHER SIGNALS	SIGNIFICATION
Day signals	 Vertical motion of a white flag or of the arms	 or firing of a green star signal	 or code letter K given by light or sound-signal apparatus	This is the best place to land
Night signals	 Vertical motion of a white light or flare	 or firing of a green star signal	 or code letter K given by light or sound-signal apparatus	
A range (indication of direction) may be given by placing a steady white light or flare at a lower level and in line with the observer				
Day signals	 Horizontal motion of a white flag or of the arms extended horizontally	 or firing of a red star signal	 or code letter S given by light or sound-signal apparatus	Landing here highly dangerous
Night signals	 Horizontal motion of a light or flare	 or firing of a red star signal	 or code letter S given by light or sound-signal apparatus	
Day signals	 1 Horizontal motion of a white flag, followed by 2 the placing of the white flag in the ground and 3 by the carrying of another white flag in the direction to be indicated	 1 or firing of a red star signal vertically and 2 a white star signal in the direction towards the better landing place	1 or signalling the code letter S (...) followed by the code letter R (...) if a better landing place for the craft in distress is located more to the right in the direction of approach 2 or signalling the code letter S (...) followed by the code letter L (...) if a better landing place for the craft in distress is located more to the left in the direction of approach	Landing here highly dangerous. A more favourable location for landing is in the direction indicated
Night signals	 1 Horizontal motion of a white light or flare 2 followed by the placing of the white light or flare on the ground and 3 the carrying of another white light or flare in the direction to be indicated	 1 or firing of a red star signal vertically and 2 a white star signal in the direction towards the better landing place	1 or signalling the code letter S (...) followed by the code letter R (...) if a better landing place for the craft in distress is located more to the right in the direction of approach 2 or signalling the code letter S (...) followed by the code letter L (...) if a better landing place for the craft in distress is located more to the left in the direction of approach	

Figure 6-3.—Lifesaving signals (page 1 of 4).

73NP0043

II Signals to be employed in connection with the use of shore lifesaving apparatus			
	MANUAL SIGNALS	LIGHT SIGNALS	SIGNIFICATION
Day signals	 Vertical motion of a white flag or of the arms	 or firing of a green star signal	In general: affirmative Specifically: rocket line is held - tail block is made fast - hawser is made fast - man is in the breeches buoy - haul away
Night signals	 Vertical motion of a white light or flare	 or firing of a green star signal	
Day signals	 Horizontal motion of a white flag or of the arms extended horizontally	 or firing of a red star signal	In general: negative Specifically: slack away - avast hauling
Night signals	 Horizontal motion of a white light or flare	 or firing of a red star signal	
III Replies from lifesaving stations or maritime rescue units to distress signals made by a ship or person			
Day signals	 Orange smoke signal	 or combined light and sound signal (thunder-light) consisting of 3 single signals which are fired at intervals of approximately one minute	You are seen - assistance will be given as soon as possible (Repetition of such signal shall have the same meaning)
Night signals	 White star rocket consisting of 3 single signals which are fired at intervals of approximately one minute		
If necessary, the day signals may be given at night or the night signals by day			
IV AIR-TO-SURFACE VISUAL SIGNALS			
Signals used by aircraft engaged in search and rescue operations to direct ships towards an aircraft, ship to person in distress			
PROCEDURES PERFORMED IN SEQUENCE BY AN AIRCRAFT			SIGNIFICATION
 1 CIRCLE the vessel at least once.	 2 CROSS the vessel's projected course close AHEAD at a low altitude while ROCKING the wings. (See Note).	 3 HEAD in the direction in which the vessel is to be directed.	The aircraft is directing a vessel towards an aircraft or vessel in distress (Repetition of such signals shall have the same meaning)

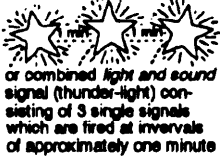
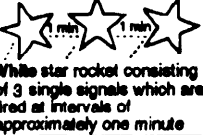
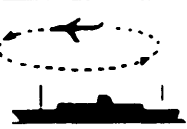
73NP0044

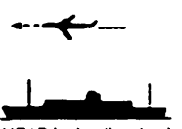
Figure 6-3.—Lifesaving signals (page 2 of 4).

RADIOTELEPHONE PROCEDURES

Any message you hear prefixed by one of the following words concerns SAFETY:

MAYDAY (Distress)—Indicates that a ship, aircraft, or other vehicle is threatened by grave and imminent danger and requests immediate assistance.





PAN (Urgency)—Indicates that the calling station has a very urgent message to transmit concerning the safety of a ship, aircraft, or other vehicle, or the safety of a person.

SECURITE (Safety)—Indicates that the station is about to transmit a message concerning the safety of navigation or to give important meteorological warnings.

IV AIR-TO-SURFACE VISUAL SIGNALS (continued)

<p>4 CROSS the vessel's wake close ASTERN at low altitude while ROCKING the wings. (See Note)</p>  <p>NOTE—Opening and closing the throttle or changing the propeller pitch may also be practiced as an alternative means of attracting attention to that of rocking the wings. However, this form of sound signal may be less effective than the visual signal of rocking the wings owing to high noise level on board the vessel.</p>	<p>SIGNIFICATION</p> <p>The assistance of the vessel is no longer required</p> <p>(Repetition of such signals shall have the same meaning)</p>
--	---

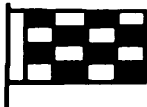
Signals used by a vessel in response to an aircraft engaged in search and rescue operations

 <p>Hoist "Code and Answering" pendant Close up; or</p>	 <p>Change the heading to the required direction; or</p>	 <p>Flash Morse Code signal "T" by signal lamp.</p>	<p>SIGNIFICATION</p> <p>Acknowledges receipt of aircraft's signal</p>
 <p>Hoist international flag "N" (NOVEMBER); or</p>		 <p>Flash Morse Code signal "N" by signal lamp.</p>	<p>Indicates inability to comply</p>

V SURFACE-TO-AIR VISUAL SIGNALS

Communication from surface craft or survivors to an aircraft.

<p>Use International Code of Signals or plain language by use of a torch, signalling lamps or signal flags</p>	or	<p>Use the following surface-to-air visual symbols by displaying the appropriate symbol on the deck or on the ground.</p>
--	----	---

Message	International Code of Signals	ICAO* visual symbols
- Require assistance	V	V
- Require medical assistance	W	X
- No or negative	N	N
- Yes or affirmative	C	Y
- Proceeding in this direction		↑

* ICAO annex 12 - Search and rescue.

Figure 6-3.—Lifesaving signals (page 3 of 4).

73NP0046

If you hear these words, pay particular attention to the message and call the master or the officer on watch.

Distress transmitting procedures are to be used only when immediate assistance is required. Use plain language whenever possible. If language difficulties are likely to arise, use appropriate tables from the *International Code of Signals*.







U.S. AND RUSSIA SUPPLEMENTARY SIGNALS

LEARNING OBJECTIVES: List and define U.S./Russia supplementary signals for naval vessels, special warning signals, and warning signals to submarines.

V SURFACE-TO-AIR VISUAL SIGNALS (continued)

Reply from an aircraft observing the above signals from surface craft or survivors.



SIGNIFICATION

 Drop a message or	 Rock the wings (during daylight) or	 Flash the landing lights or navigation lights on and off twice (during hours of darkness) or	 Flash Morse Code signal "T" or "R" by light or	Use any other suitable signal	Message understood
 Fly straight and level without rocking wings or	 Flash Morse Code Signal "RPT" by light or	Use any other suitable signal			Message not understood (repeat)

VI SIGNALS TO SURVIVORS

Procedures performed by an aircraft.



SIGNIFICATION

Drop a message or 	Drop communication equipment suitable for establishing direct contact 		The aircraft wishes to inform or instruct survivors
---	---	--	---

*High visibility colored streamer

Signals used by survivors in response to a message dropped by an aircraft.

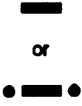
SIGNIFICATION

Flash Morse Code signal "T" or "R" by light or 	use any other suitable signal		Dropped message is understood by the survivors
Flash Morse Code signal "RPT" by light 			Dropped message is not understood by the survivors

73NP0046

Figure 6-3.—Lifesaving signals (page 4 of 4).

On the 25th of May 1972, an agreement between the governments of the United States and the Soviet Union on the prevention of incidents on the high seas was signed. This agreement was called the INCSEA agreement. The purpose of this agreement is to reduce the number of unintended serious confrontations between the United States and Soviet Forces on or over the high seas, to promote safety of operations where the United States and Soviet Naval and Air Forces operate in proximity, and to avoid the breaking of diplomatic relations.

As a part of this agreement, the U.S. and Russian warships and auxiliary vessels will use the signals listed below:

- IR 1 I am engaged in oceanographic operations.
- IR 2 I am streaming/towing hydrographic survey equipment...meters astern.
- IR 3 I am recovering hydrographic survey equipment.
- IR 4 I am conducting salvage operations.
- JH 1 I am attempting to retract a grounded vessel.

MH	1	Request you not to cross my course ahead of me.	UY	2	I am preparing to conduct missile exercises. Request you remain clear of the hazard which is in the direction from me as indicated...(table 3 of ICS).
NB	1	I have my unattached hydrographic survey equipment bearing in a direction from me as indicated...(table 3 of ICS).	UY	3	I am preparing to conduct gunnery exercises. Request you remain clear of the hazard which is in the direction from me as indicated...(table 3 of ICS).
PJ	1	am unable to alter course to my starboard.	UY	4	I am preparing to conduct/am conducting operations employing explosive charges.
PJ	2	I am unable to alter course to my port.	UY	5	I am maneuvering in preparation for torpedo launching exercises. Request you remain clear of the hazard which is in the direction from me as indicated...(table 3 of ICS).
PJ	3	Caution I have a steering casualty.	UY	6	I am preparing to conduct/am conducting underway replenishment on course... Request you remain clear.
PP	8	Dangerous operations in progress. Request you remain clear of the hazard which is in the direction from me as indicated...(table 3 of ICS).	UY	7	I am preparing to conduct extensive small boat and ship to shore amphibious training operations.
QF	1	Caution I have stopped engines.	UY	8	I am maneuvering to launch/recover landing craft/boats.
QS	6	I am proceeding to anchorage on course...	UY	9	I am preparing to conduct/am conducting helicopter operations over my stern.
QV	2	I am in a fixed multiple leg moor using two or more anchors or buoys fore and aft. Request you remain clear.	UY	10	I am testing my gun systems.
QV	3	I am anchored in deep water with hydrographic survey equipment streamed.	UY	11	I am testing my missile systems.
RT	2	I intend to pass you on your port side.	UY	12	I am preparing to conduct/am conducting gunnery/bombing exercises from aircraft on a towed target. Request you remain clear of the hazard which is in the direction from me as indicated...(table 3 of ICS).
RT	3	I intend to pass you on your starboard side.	ZL	1	I have received and understood your message.
RT	4	I will overtake you on your port side.	ZL	2	Do you understand? Request acknowledgment.
RT	5	I will overtake you on your starboard side.			
RT	6	I am/Formation is maneuvering. Request you remain clear of the hazard which is in the direction from me as indicated...(table 3 of ICS).			
RT	7	I shall approach your ship on starboard side to a distance of...100's of meters yards).			
RT	8	I shall approach your ship on port side to a distance of...100's of meters (yards).			
RT	9	I shall cross astern at distance of...100's of meters (yards).			
RU	2	I am beginning a port turn in approximately... minutes.			
RU	3	I am beginning a starboard turn in approximately...minutes.			
RU	4	The formation is preparing to alter course to port.			
RU	5	The formation is preparing to alter course to starboard.			
RU	6	I am engaged in maneuvering exercises. It is dangerous to be inside the formation.			
RU	7	I am preparing to submerge.			
RU	8	A submarine will surface within 2 miles of me within 30 minutes. Request you remain clear.			
TX	1	I am engaged in fisheries patrol.			
SL	2	Request your course, speed, and passing intentions.			
UY	1	I am preparing to launch/recover aircraft on course....			

SIGNALING

The INCSEA signals may be signaled by the following methods authorized by the ICOS:

- Flaghoist
- Flashing light
- Voice
- Morse signaling by hand flags or arms

Signals taken from the INCSEA agreement are preceded by the local code indicator "YVp1." Yvp1 and the signal will be separated by a tack.

Acknowledge

To acknowledge signals from the INCSEA, use the signal YVp1 TACK ZLp1. The acknowledge

signal is not hoisted to the dip; instead it is hoisted closed up after the signal is understood by the appropriate personnel.

Question

To question signals from the **INCSEA** agreement, the signal YVpl TACK ZLp3 will be used.

Cancel

To cancel signals from the **INCSEA** agreement, the code pennant followed by either *YN* or *ZP* must precede the group that cancels.

SPECIAL WARNING SIGNALS

To inform foreign naval vessels that they have violated Soviet spaces, will use the warning signals listed below:

- SNG You have violated the state border of the Soviet Union. I demand that you leave Soviet Union waters immediately.
- SNO I demand that you leave the waters of the Soviet Union immediately. Unless you do so, a force of arms will be used against you.
- SNP You are violating the regulations for navigating and remaining in Soviet Union waters. I demand that you cease violations.
- SNR Despite warnings, you continue to violate the regulations for navigating and remaining in Soviet Union waters. You are to leave them immediately.

During the day, these signals will be made by flags. During nighttime, these signals are made by Morse code using a signal lamp. Radiotelephone may also be used to transmit the signal, as well as voice using a megaphone or any other amplifying device.

WARNING SIGNALS TO SUBMARINES

The signal of two series of explosions with three explosions in each series (where the interval between the explosions in a series is 1 minute and the interval between the series is 3 minutes) means “You are in Soviet Union waters. I demand you surface immediately. Unless you comply with this order

within 10 minutes, a force of arms will be used against you.”

An acoustic signal by sonar may be given simultaneously, with the same meaning as stated previously. The signal will consist of five dashes, each dash 3 seconds long, and the interval between dashes, 3 seconds.

INDEX

LEARNING OBJECTIVES: Explain the procedures for the use of the index.

The index is divided into two separate indexes: Index 1 is the Signaling Instructions and General Signal Code and Index 2 is the Medical Signal Code.

USE AND CONSTRUCTION OF GROUPS

The types of signals used are the following:

Single-letter signals—Indicate very urgent, important, or very common use

Two-letter signals—The general code

Three-letter signals—Begin with *M* and indicate the medical code

The Code follows the basic principle that each signal should have a complete meaning. This principle is followed throughout the Code. In certain cases, complements are used when necessary to supplement the available group.

To find a certain group when encoding, always turn first to the signal index or medical index, as appropriate, and pick out the key word or phase.

Examples:

Do you require a boat? KEY WORD: Boat

Explosion has occurred in tank. KEY WORD: Explosion

COMPLEMENTS EXPRESS

The use of complements is explained in the following paragraphs. You as a Signaller must know how to use complements to effectively communicate with merchantmen.

Variations in the meaning of the basic signal:

CP—I am (or vessel indicated is) proceeding to your assistance.

CP 1—SAR aircraft is coming to your assistance.

Questions concerning the same basic subject or basic signal:

DY—Vessel (name or identity signal) has sunk in lat. . . long. . .

DY 4—What is the depth of water where vessel sank?

Answers to question or request made by the basic signal:

HX—Have you received any damage in collision?

HX 1—I have received serious damage above the waterline.

Supplementary, specific, or detailed information:

IN—I require a diver.

IN 1—I require a diver to clear propeller.

General signal complements appearing in the text are grouped into three tables. These tables should be used only as and when specified in the text of the signals. The tables of complements are as follows:

Table 1—Communication

1. Morse signaling by hand flags or arms
2. Loud hailer (megaphone)
3. Morse signaling lamp
4. Sound signals

Table 2—Logistics

0. Water
 1. Provisions
 2. Fuel
 3. Pumping equipment
 4. Fire-fighting appliances
 5. Medical assistance
 6. Towing
 7. Survival craft
 8. Vessel to stand by
 9. Icebreaker

Table 3—Compass Directions

0. Direction unknown (or calm)
 1. Northeast
 2. East
 3. Southeast
 4. South
 5. Southwest
 6. West
 7. Northwest
 8. North
 9. All directions (or confused or variable)

The medical signal complements are grouped into three separate tables. As for the general signal complements, the tables should be used only as and when specified in the text of the signals. The medical signal complement tables are as follows:

Table M-1—Regions of the body

Table M-2—List of common diseases

Table M-3—List of medicaments

CROSS-REFERENCES

Cross-references should be used when you are dealing with signals of same subject. These references are found in the right column. Before making additional reference to the index, use extensive cross-references to facilitate coding.

Example:

EL—See right column for cross-reference

SUMMARY

In this chapter you learned how to communicate with merchantmen using flaghoist, flashing light, Morse signaling by hand flag or arms, sound, and radiotelephony. You were taught the international distress signals and about the use of the U.S./Russia supplementary signals. Now it is up to you to put what you have learned to use.

CHAPTER 7

CONVOY COMMUNICATIONS

Although now generally accepted, convoys were once the subject of bitter but sincere arguments by professional seamen. Many felt that concentrating targets in one area merely made it easier for the enemy. Statistics, however, prove the worth of the convoy system of ocean transit.

When many ships steam in company, communication is difficult. In a convoy the predicament is even more extreme because merchant vessels, as well as Navy vessels, are involved. Navy personnel spend most of their years at sea steaming in company with other ships, whereas people serving in the merchant marines during peacetime steam independently. Communication is further complicated by the language barrier. Convoys are usually made up of ships of many different nations, traveling in company for mutual safety and manned by people who speak different languages.

NAVAL CONTROL OF MERCHANT SHIPPING

LEARNING OBJECTIVES: Explain the Naval Control of Shipping Organization (NCSORG) and identify the structure within.

In time of peace, merchant shipowners and operators direct and control the movement of their ships to meet commercial requirements worldwide.

During periods of mounting tension where merchant ships might be subjected to harassment at sea, governments may take preliminary measures to bring merchant ships under voluntary naval control in preparation for the assumption of full allied naval control when the situation warrants. In this period, only the movement of the ships will be controlled, and that only in the limited area where it may be necessary to offer some form of protection. The use of the ship would still be up to the owner/operator.

In time of war, full naval control of merchant shipping will be instituted by governments to operate under the Allied Naval Control of Shipping. The control of merchant shipping in war is based on the concept that the control of the use of merchant ships

will be by the Civil Direction of Shipping Organization (CDSORG) and that the control of the movement of merchant ships will be by the NCSORG.

CIVIL DIRECTION OF SHIPPING ORGANIZATION (CDSORG)

At or just before the outbreak of war, the CDSORG will assume the responsibility for the employment of all oceangoing merchant ships of NATO countries. The term *employment* is intended to cover cargo, loading, maintenance, discharging, repair, manning, harbor movement, and so forth. These operations are similar to those performed by owners and operators during peacetime but are directed to the fulfillment of allied requirements for ocean transport in the prosecution of the war.

Employment of merchant ships under the control of the Commander Military Sealift Command (COMSC) will not be determined by the CDSORG. Employment of those ships will be determined by the COMSC.

NAVAL CONTROL OF SHIPPING ORGANIZATION (NCSORG)

The NCSORG exercises authority for the control and direction of ship movement. Control is effected through Naval Control of Shipping offices established in most primary and secondary ports throughout the world. The control of ship movement includes selection of routes, organization of convoys, tactical diversions, movement reporting, and so forth.

OPERATIONAL CONTROL AUTHORITY (OCA)

The operational control authority (OCA) is the naval commander responsible for the movement and the protection of allied merchant ships within his/her command area. The OCA is required to do the following:

1. Maintain adequate systems of communication, intelligence, and plotting to ensure rapid and secure dissemination of operational intelligence.

2. Sail ships in convoy or as independents according to policies set forth.

3. Arrange protection in port and at sea for merchant ships under his/her control.

4. Maintain operational control of the Naval Control of Shipping officers and reporting officers in his/her area.

NAVAL CONTROL OF SHIPPING OFFICER (NCSO)

The NCSO controls and coordinates the routing and movement of merchant ship convoys and merchant ships moving independently out of assigned ports. The NCSO deals indirectly with the ships' masters from the time the masters report for routing to the time they depart to a convoy anchorage to await inclusion in a convoy. If the ship is independent, the NCSO deals indirectly with the master until the ship leaves the harbor for its next port designation. The NCSO's operational duties include the following:

- Briefing masters
- Obtaining and checking data prior to sailing
- Checking vessel's convoy eligibility
- Inspecting communications equipment
- Issuing sailing permits and orders
- Organizing convoy conferences
- Assisting masters with local operating problems
- Providing instructions on the Crypto system
- Arranging for pilots
- Arranging convoy anchorage berth
- Routing and movement of vessels
- Checking and issuing publications
- Checking and issuing charts and hydrographic publications

VOLUNTARY NAVAL CONTROL OF SHIPPING (VNCS)

During periods of international tension, provocative incidents, particularly at sea, are a real possibility. Should this occur, it is hoped there can be a voluntary, smooth, and gradual progression from a peacetime organization to full naval control of shipping if required.

Command Structure

For operations, the seas of the world have been divided into merchant shipping areas, each commanded by an area commander. The area commander is responsible for Naval Control of Shipping measures both in port and at sea in his/her area.

Detailed operational control may be delegated by the area commander to subordinate commanders who are known as OCAs.

The NCSO is the OCA's representative at a port.

Escalating Situation

When in peacetime a situation develops that represents a threat to the passage of allied merchant shipping through a particular area or areas, the NCSORG is established. First they are to advise, and if the situation escalates to what is considered to be a dangerous level, they are to direct allied merchant shipping so that, when necessary, protection can be provided. With the establishment of the NCSORG, National Shipping Administration/Ministries will encourage shipowners/operators to consign their vessels to voluntary naval control.

Advice to Shipping

Merchant ships will be advised of the situation by an instruction to open an envelope (envelope *T*), carried by the ships in peacetime and containing a set of instructions for VNCS.

If the ship is in a port where there is an NCSO, the master will be visited by an officer of the NCSO's staff, whose task is to make sure the master has an up-to-date briefing on the situation and to collect information on the ship's voyage that will enable a plot to be kept ashore. Subsequently, a further briefing will take place at each port. If the ship is not contacted on arrival, the ship's master should contact the NCSO.

Control of Shipping

There is little action required of the merchant ship other than to accept the briefing and to supply the plot information. There will be no positive form of control of shipping until it becomes necessary to establish and promulgate clearly designated danger zones where the threat is high. The establishment of such a zone (called a MERZONE) will be made at the highest political/military level.

Ships that pass through the MERZONE will be given a route to follow through the zone. Only those ships whose passage must take them into the zone will be controlled this way, and then only while actually within the boundaries of the zone.

VNCS is, as its name states, voluntary throughout and can only be imposed with the consent of the shipowner, who may withdraw his or her ship from Navy control at any time.

NAVAL CONTROL OF SHIPPING IN WAR

At the declaration of war or at the point when it is decided to place merchant shipping on a war footing, all oceangoing merchant ships will be committed to employment by the CDSORG for the prosecution of war and survival of Allied Nations. This will involve the pooling of ocean shipping resources and compulsory acceptance by masters of the control of movement by the Allied NCSORG.

Command Structure

The command structure for NCS will be similar to that specified for periods of tension. The CDSORG, for the employment of merchant ships, will be staffed by officials drawn from peacetime government shipping agencies and shipping companies.

Coastal vessels

Ships below 1600 GRT and those larger vessels declared solely to coastal operation will not be pooled, but will remain under national control throughout the war.

Control of Shipping

Whether or not ships are sailed in convoy, there will be positive control of merchant ship movements of all types. The level of control will vary according to the tactical situation at the place and time, but in its very lowest form will require that each merchant ship

1. obtain permission to sail, and
2. be given a route to follow.

COMMAND AND RESPONSIBILITIES

LEARNING OBJECTIVES: Identify and explain the duties of the officer in tactical command (OTC), convoy commodore, vice commodore, and the rear commodore.

The safe passage of a convoy depends on the organization of the convoy before sailing, the management and control of the convoy at sea, and the skillful handling of each ship while in convoy. Convoy operations must be understood by every master and watchkeeping officer if each ship is to play her individual part.

OFFICER IN TACTICAL COMMAND (OTC)

The OTC is the senior naval officer present or the officer to whom command has been delegated. The OTC is responsible for the defense of the convoy and the enforcement of such instructions and orders as are related to the defense of the convoy.

CONVOY COMMODORE

The convoy commodore is the officer, naval or merchant, designated by naval authority to command the convoy. The convoy commodore is subject to orders of the OTC. In the absence of an escort, he/she takes entire command.

The convoy commodore is responsible for the internal operations of the convoy. This responsibility includes the assignment of stations to ships in the convoy after the convoy leaves the harbor, the issue of instructions and regulations for the convoy, the safe navigation of the convoy as a whole, and for the communication organization of the convoy within the policy of the OTC. The convoy commodore should consult with OTC, whose navigational facilities are normally superior, regarding safe navigation, particularly in channels and mineable waters. Under normal conditions, the convoy commodore will control the convoy tactically, following standard instructions for convoys and such additional instructions as may be received from competent authority. He/she is responsible for the readiness for action and conduct in action of the merchant ships under his/her command. If the convoy commodore is incapacitated or forced to relinquish command of the convoy, his/her duties are assumed by the vice commodore. After the vice commodore, the rear commodore takes over.

When required to make good a specified course or to follow a specified route, the commodore must be particularly careful that allowance is made for wind and tide. The commodore must also ensure that the guide of the convoy steers an accurate course and that the remaining ships maintain their ordered stations.

When conditions, such as travel through narrow waters, make a commodore's control of the convoy impracticable, the convoy must be ordered to proceed independently. The masters will then know they should no longer look for guidance.

Although the commodore is responsible for the safe conduct and information of the convoy, **MASTERS, INDIVIDUALLY, ARE AT ALL TIMES RESPONSIBLE FOR THE SAFE NAVIGATION AND HANDLING OF THEIR SHIPS.**

The commodore will issue maneuvering orders to ships in convoy. The OTC may request the commodore to order a maneuver, and the transmission be overheard. Care must be exercised by merchant ships to ensure that only those orders addressed to them are obeyed. Orders from the OTC to the commodore are not intended for the ships in convoy until relayed by the commodore and addressed to ships in the convoy.

VICE COMMODORE

The vice commodore, if assigned, will sail in a ship other than that in which the convoy commodore sails. His/her duties are to assist the commodore and to assume the duties of convoy commodore should the convoy commodore's ship become incapacitated. If the convoy splits, he/she may take charge as commodore of a section.

REAR COMMODORE

The rear commodore, if assigned, assists the commodore and vice commodore in their tasks and acts for them in their absences. If the convoy splits, he/she may take charge of a section.

SPECIAL CONVOY FLAGS

LEARNING OBJECTIVES: List and define special flags flown in convoy formations.

The majority of flags used in convoy communications will be familiar to signalmen because of their normal use in international and Allied communications.

COMMODORE'S FLAG

A large XRAY flag is flown by the commodore's ship while the convoy is forming up or reforming or

whenever the commodore wishes to make the ship readily identifiable. It is flown on similar occasions by the vice or rear commodore's ship when such officer has assumed command of the convoy or is acting independently of the commodore when in charge of some of the convoy.

CONVOY FLAG

The NCSO at the port of departure of a convoy will assign a distinguishing flag to be flown by all ships and escorts in a particular convoy. It only has local and temporary significance to assist in mutual recognition.

GUIDE FLAG

The commodore's ship normally acts as the guide ship of the convoy, but he or she may have another ship to take over as guide. A ship ordered to take over as guide will immediately hoist her largest merchant ensign and keep it flying as long as she remains guide.

CONVOY FORMATION

LEARNING OBJECTIVES: Explain the procedures for the forming of ships in a convoy formation.

The arrangement of ships in a convoy is termed *convoy formation*. While convoys have traditionally been formed in columns in line ahead on a broad front, higher speeds and different types of merchant ships, and the modern vehicles, weapons, and sensors of opposing forces may require convoys to be of any size or shape in order to get the best protection possible.

CONVOY GRID SYSTEM

A formation grid is shown in figure 7-1; the grid allows almost total variation of ship stations within a convoy. The formation grid also allows for the situation where it is considered that several small but interrelated convoys are required.

Escorts may or may not be stationed on the same grid system. Convoy station designators are used as convoy internal call signs (see fig. 7-1).

The convoy will be formulated by the OCA, OTC, commodore, NCSO, and the Sailing Order Folder issued to each ship before sailing. Once at sea, the

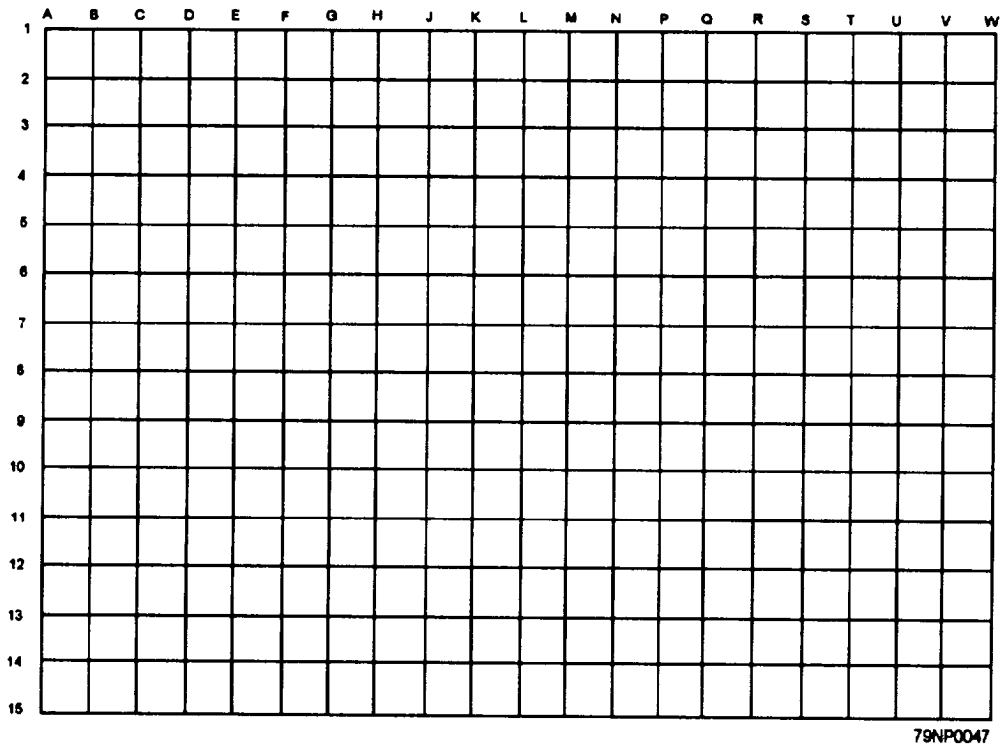

79NP0047

Figure 7-1.—Convoy formation grid.

OTC is responsible for the convoy formation, and at any time he/she may require alterations to it.

left to right and prefixed with zero, commencing with 01, for the left column.

COLUMN NUMBERING

When a convoy is formed in a broad formation (fig. 7-2), each column is numbered sequentially from

LANE NUMBERING

Lanes are the spaces between the columns (see fig. 7-2) and the adjacent areas to the left of column 01 and

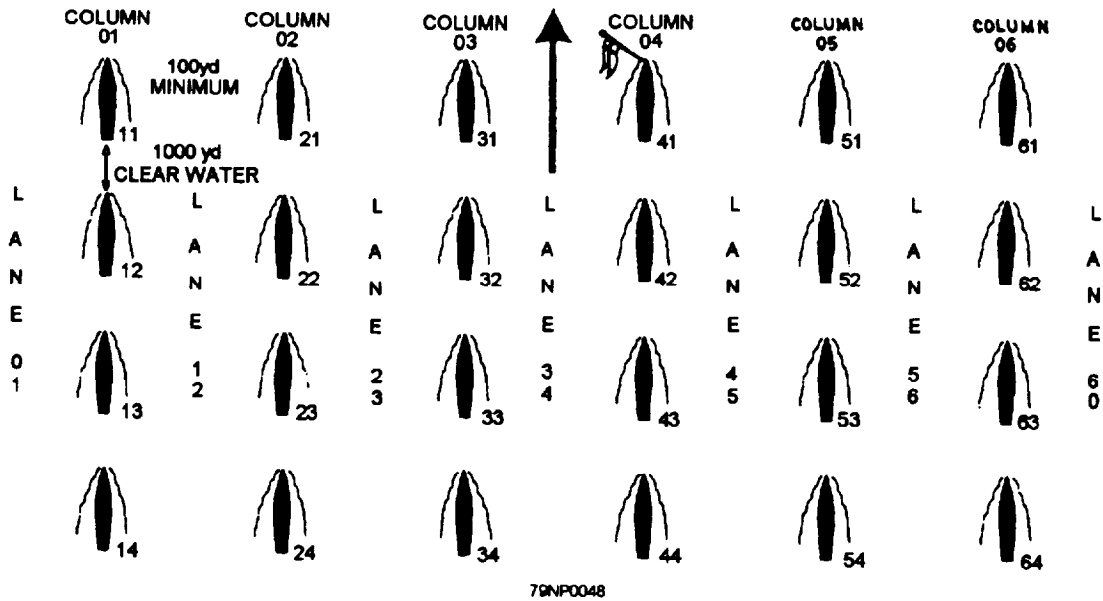

79NP0048

Figure 7-2.—Column and lane numbering.

to the right of the right column. Internal lanes take a number composed of the adjacent column numbers less the prefix 0. The left lane is numbered 01, and the right lane takes the number of the right less the prefix 0 but with the suffix 0 added.

COLUMN CALL SIGNS

The column number is to be used as the collective call sign for ships in that column, preceded by the word *column*.

Example:

Column zero four

LIGHT REPEATING SHIPS

If the convoy is large, special light repeating ships may be designated to relay flashing-light messages from the commodore.

GUIDES OF A CONVOY

One ship in the formation will be designated as the convoy guide. The duty of the guide is to maintain accurately the course and speed ordered. If the ships are in a single column, the leading ship will be the guide. If, for any reason, the leading ship falls out of line, the ship next astern of it becomes the guide of the column.

If the convoy consists of two or more columns, one of the column guides also must act as convoy guide. The convoy guide must maintain the course and speed ordered, and guides of columns must keep their correct station on the convoy guide. Ships in each column are to keep station on the guide of their respective column.

Should the guide be disabled and become incapable of acting as guide, the leading ship of the next column to starboard is immediately to become convoy guide without further orders. If there is no column to starboard, the leading ship of the next column to port is to become the guide. If the convoy is in any formation other than columns in line ahead, a new guide will be detailed by signal. A ship becoming guide will immediately hoist her largest merchant ensign at the masthead.

If the commodore has detailed some other ship to act as convoy guide and later wishes to make a further change, he/she will make a signal indicating which ship is to become convoy guide. When this signal is executed, the ship that has been acting as guide will

haul down her merchant ensign and cease to act as guide. At the same time, the new guide is to hoist her largest merchant ensign and become the guide. If the new guide is the commodore's flagship, execution of the signal will indicate that the commodore has reassumed the guide.

The convoy guide and column guides remain the same if the convoy alters course by any of the following methods:

1. By all ships turning simultaneously less than 90° to starboard or port
2. By wheeling (altering course in succession)
3. By column leaders turning simultaneously, the remainder in succession

CHANGES OF THE GUIDE

To assist station-keeping in a convoy formed in columns, the convoy guide is to change automatically when all ships turn simultaneously through 90° or more.

If the convoy alters course, with all ships turning simultaneously exactly 90° to starboard or port, forming line abreast, the port or starboard wing ship respectively of the new leading line abreast automatically becomes the convoy guide and without further orders hoists its largest merchant ensign. The previous guides of columns, however, do not change but become guides in the line abreast. In figure 7-2, if ships turn together 90° to starboard, number 61 automatically becomes convoy guide. Numbers 11, 21, 31, 41, 51, and 61 remains guide of the respective lines abreast.

If the convoy alters course, with all ships turning more than 90°, the ship now leading the column originally led by the convoy guide automatically becomes the convoy guide. The ships now leading the columns become the new guides of their respective columns. Thus, in figure 7-2, if the ships turn together more than 90°, number 44 automatically becomes the convoy guide, and numbers 14, 24, 34, 44, 54 and 64 become the new guide of their columns.

When a convoy is in a formation other than columns in line ahead, it may be desirable for the convoy commodore to designate certain ships as group guides. Such ships are to take charge of their groups in cases of emergency and, if necessary, act on their own initiative.

TAKING UP FORMATION

When forming a convoy, ships should get to their correct station as quickly as possible, relative to the guide of the convoy.

If the convoy is in columns in line ahead or in a formation involving small groups of ships, each column/group guide will take station on the guide of the convoy and station themselves on the guide of their own column/group.

Ships should maintain their station in the formation on their guide, and should not be influenced by the movement of other ships unless the danger of collision occurs.

While forming up, ships are to hoist their convoy station (convoy internal call sign) and keep it flying until all ships are in station.

In narrow waters, each ship should make full allowances for wind and tide so as to pass over the same ground as the leading ship. This will not necessarily be achieved by following the wake of the next ship ahead.

COMMUNICATION INSTRUCTIONS

LEARNING OBJECTIVES: List and explain the primary and secondary means of convoy communications. Explain the use of external ship/shore communication. List the responsibilities of the master and communication plan. List pubs used for convoy signals. List day and night signals for open and closed ports.

The following types of communications are available:

1. Primary: Radiotelephone
2. Secondary: Flashing Light

RADIOTELEPHONE

The voice radiotelephone (R/T) procedure prescribed in ATP 2, volume II, is to be used for all voice radio communication. The convoy commodore is net control for voice radio communications. As was stated for allied voice communications, adherence to the prescribed procedure and good circuit discipline are essential to being efficient.

Phonetic Alphabet

When necessary to identify any letter of the alphabet, the standard phonetic alphabet is used. The correct pronunciation may be found in the *International Code of Signals*.

Numeral Pronunciation

Numerals, in transmission, are to be spoken in the English language. Only in cases of difficulty is the INTERCO system used.

Numerals are to be transmitted DIGIT BY DIGIT.

Prowords

The prowords found in ATP 2, volume II, in general, correspond to those in ACP 125, with the following exceptions:

ALARM—This ship has sighted or been attacked by hostile or suspicious forces.

KICK—Carry out antijamming procedures.

REPEAT—Repeat transmission or portion indicated, or I repeat.

CALL SIGNS

Individual ship call signs vary according to the circumstances in which they are used. Where no other instructions have been received, the following rules apply:

1. In harbor, for communications with local harbor authorities, use ship name or international call signs.
2. Independently routed ships, see the communications supplement of ATP 2, volume II.
3. In convoy, ships use their convoy station designations as their R/T and visual call sign. When transmitted by R/T, the station designation is preceded by the word *ship*.

Special call signs for use within a convoy are shown in figure 7-3.

EXECUTIVE MESSAGES

Executive-type messages that are sent over the convoy radiotelephone net will include the proword EXECUTE TO FOLLOW immediately after the call, and the text is repeated twice. If there is a delay of several minutes between the transmission and the

SHIP OR AUTHORITY	VOICE RADIO/ FLASHING LIGHT
COMMODORE	BULL
VICE COMMODORE	CALF
REAR COMMODORE	COLT
CONVOY (COLLECTIVELY)	TEAM
THIS, OR SECTION . . .	SACK
OTC	BOSS
ESCORT SHIPS (COLLECTIVE)	GANG
ESCORT SHIPS (INDIVIDUAL)	SODA
RESCUE SHIPS	CORK*
GUIDED MISSILE SHIP	SHOT
ESCORTING AIRCRAFT	PLANK
STRAGGLERS	LAZY
*followed by 1,2,3, etc. as necessary	

Figure 7-3.—Convoy special call signs.

execution, the text may be repeated prior to sending “STANDBY-EXECUTE.”

FLAG SIGNALING

Flag signaling procedures are based on those found in Pub 102, with the following additional rules:

- A flaghoist without a call is addressed to the commodore when made by a ship in the convoy, or it is addressed to the convoy when made by the commodore.
- The moment of execution is the moment when the hoist is hauled down.
- When hoisted by a warship, signals from ATP 2, volume II, will be preceded by the 4TH substitute.
- Signals from Pub 102 will be preceded by the code pennant.
- All flag signals are to be repeated flag for flag. Remember flags, merchant ships do not carry 4TH substitute.

FLASHING LIGHT

Flashing light should be restricted to minimum use. Both directional and non-directional light may be used.

These procedures are based on those found in the *International Code of Signals*, except for the following procedure signs:

FFFF—Used preceding a call to order the called station not to answer this transmission.

IX—Action on the message or signal which follows is to be carried out upon receipt of the prosign IX 5 SECOND FLASH.

IX 5 SECOND FLASH—Carry out the purpose of this message or signal to which this applies.

Executive method is normally used for transmitting a maneuvering signal or other signals requiring simultaneous actions.

PYROTECHNICS

Pyrotechnics are designed for use at night in case of extreme urgency, threat of enemy attack, or when thick weather justifies their use for maneuvering.

The use of pyrotechnics for maneuvering in convoy is left entirely to the commodore's discretion, and if used, they are for emphasizing the urgent nature of the maneuver.

With the possible danger of cargo explosion from fumes, masters with dangerous cargos should exercise their discretion in regard to the firing of rockets and pyrotechnics.

Independently routed merchant ships are to fire NO LESS THAN TWO WHITE ROCKETS if they are damaged by enemy action between dusk and dawn. This should, in good visibility, serve to attract the attention of naval vessels and aircraft, as well as warn other merchant ships in the area. Masters of independently routed ships should turn directly away upon sighting this signal.

A ship in convoy that sighted a previously undetected enemy submarine or surface craft or which is torpedoed must immediately fire at least TWO WHITE ROCKETS IN QUICK SUCCESSION.

If a ship in convoy accidentally fires a rocket or other pyrotechnic device, that ship should immediately make the colored signal for negative (white over red over green). In addition, the letters *NO* may be sounded on the ship's siren (ship's whistle). This should prevent the escort from taking the usual countermeasure against enemy attack.

Rocket and pyrotechnic signals and their meanings are contained in ATP 2, volume II, table II-V.

RADIOTELEGRAPH

Radiotelegraph messages are to be sent over the radiotelephone net. The entire radiotelegraph version of the message is to be passed as the text of the radiotelephone message.

SHIP/ShORE TRANSMISSION

Ship/shore radiotelephone transmissions are to be made according to the *International Telecommunications Union Regulations*, article 33.

MASTER'S COMMUNICATIONS RESPONSIBILITIES

The master, like the allied commanding officer, has overall responsibility for all communications maintained by his/her ship. He/she therefore has the authority and the obligation to order or prohibit any transmission being made from his/her ship. He/she decides whether or not to break radio silence and to permit or refuse participation in distress traffic.

On arrival in an allied port, the master reports immediately to the NCSO all defects in communications equipment that cannot be repaired on board before the ship sails again.

The master is also responsible for ensuring that all communications personnel are knowledgeable of the instructions necessary for the performance of their communication duties, and to ensure that any orders received are passed to them.

The master will be furnished with the necessary publications by the NCSO. He/she is responsible for them and must ensure all instructions for the maintenance and security of the pubs are observed and that amendments are inserted.

COMMUNICATIONS PLAN

The communications plan is an important part of the Sailing Order Folder. Basic radio communications organization and procedures for all ships, sailing independently or in convoy, upon which the radio communications plan will be based, are found in the communications supplement of ATP 2, volume II.

SIGNALS USED IN CONVOY

Ships in convoy are to use the signals provided in ATP 2, volume II, *the International Code of Signals* or the International Q code. Subject to the transmission policy in force, these signals may be transmitted by voice radio or visually.

The majority of the signals required in convoy operations can be found in ATP 2, volume II, chapters 11, 12, and 12A.

When warship Signalmen make use of those signals, they will be preceded with the 4TH substitute.

Vocabulary

The vocabulary, chapter 12, consists of three-letter signal groups, each starting with the letter X. Groups are arranged in alphabetical sequence for ease of reference. This chapter is used for encoding. Chapter 12A is used for decoding.

Maneuvering Signals

Chapter 11 contains maneuvering signals, maneuvering instructions, supplementary signals, and single-letter signals.

Single-Letter Signals

Single-letter signals in ATP 2, volume II, are contained in table 11-VI. Flags *T* and *W* will precede the port or starboard pennant and three numerals to indicate the direction of the alteration of course. Single-numeral pennant signals are also found in chapter 11, table 11-VII.

NOTE

The Code pennant is to precede signals taken from INTERCO. It should be noted that single-letter signals from the INTERCO have different meanings than signals from ATP 2, volume II.

CLASSIFIED RECOGNITION SIGNALS

Extracts of recognition material will be issued to each ship by the NCSO. The current period signal must be given to the officer of the watch. Ships must identify themselves promptly when challenged by allied warships, aircraft, examination vessels, or the signal station.

TIME USED IN SIGNALS

GMT is to be used in all communication. Clocks are to be set and so labeled.

MAN OVERBOARD

A ship that loses a person overboard must immediately make the signal "MAN OVERBOARD"

on voice radio, and hoist flag “OSCAR” by day, and flash *O* to ships astern both day and night.

The ship is to put the rudder over to avoid striking the person; she also will not try to pick the overboard person up. The last ship in the column will try to pick up the person. The escort forces will also try to pick up the person.

PORT EXAMINATION SERVICE

In certain circumstances, it may be necessary for national authorities to control the entrance of ships into certain ports. The signals in figure 7-4 should be displayed by signal stations or by port examination service vessels.

Examination-service vessels will, in addition, fly by day a distinguishing flag (fig. 7-5).

COMMUNICATION CONFERENCES

LEARNING OBJECTIVES: Explain the, purpose of the convoy communication and Signalman conferences.

Uniformity of communications procedures is of the utmost importance in convoy communications. General communications instructions, radio and radar watches, electronic emissions, communications security policies, and recognition and identification are the minimum that should be covered by all communications personnel prior to a convoy sailing.

CONVOY COMMUNICATION CONFERENCE

The NCSO will arrange a conference to be attended by merchant ship radio officers, naval communication officers, and senior rating. It will normally take place immediately after the convoy conference and will deal with convoy communications in detail.

CONVOY SIGNALMAN CONFERENCE

This conference is normally held after the communication conference for Signalmen.

The communications officer conducting the conference will ensure that Signalmen are familiar with visual signaling used in convoys, especially executive method signaling, identification procedures, and procedures for sending signals.

SIGNAL	MEANING
RED RED RED	FIXED—Do not proceed/Port is closed FLASHING— Emergency. Do not proceed/port is closed
GREEN GREEN GREEN	Port is open You may proceed One-way traffic
GREEN GREEN WHITE	Port is open You may proceed Two-way traffic
GREEN WHITE GREEN	Port is open You may only proceed when ordered to do so

Figure 7-4.—Port traffic signals.

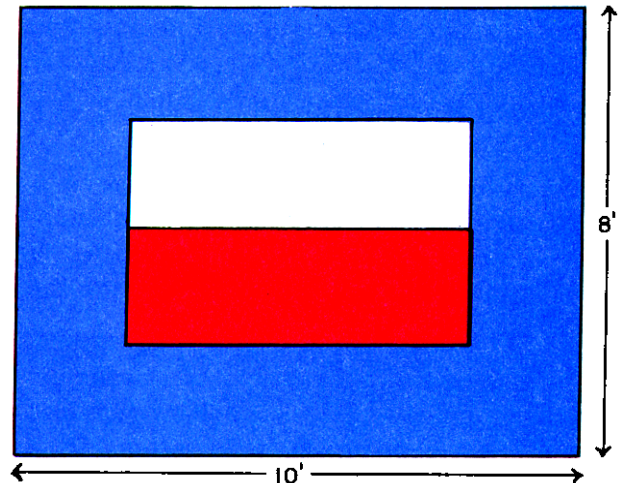

Figure 7-5—Examination-service flag.

SUMMARY

In this chapter you learned how to communicate in a convoy using radiotelephone, flashing light and flaghoist. You learned the function of the convoy organization, including that of the OCA, CDSORG, and the NCSORG. You learned about the different convoy formations and how to change guides. You learned about the port examination services and communication conferences. Review this chapter frequently to become familiar with convoy communication. To become even more knowledgeable, study ATP 2, volume II.

CHAPTER 8

WATCHSTANDING DUTIES

Visual communications at sea usually involve messages that require specific and often immediate compliance. Through tactical communications, ships are joined in formation and maneuvered together as a unit; combat information, passed rapidly between ships, weapons, and aircraft, are coordinated for attack or mutual defense of the group.

Because of their importance, tactical communications are handled by specially trained, responsible personnel. Usually the staff communications officer or staff watch officer on a flagship disseminates signals for the officer in tactical command (OTC) by voice radio located in the flag plot, or through the flagship signal bridge. On other ships in the force, tactical communications are handled by key personnel that assist the commanding officer in receiving and interpreting communications. These personnel include the OOD, JOOD, CIC personnel, and the signal watch.

The signal officer, if one is assigned, takes direct charge of the signal bridge during maneuvers, tactical drills, general quarters, and when the ship is leaving or entering port.

Basic communications doctrine stipulates that visual signaling, in preference to radio, be used for communicating whenever practicable. Visual communications, therefore, constitutes an integral part of the overall communications effort of the ship. The signal bridge plays an important role in the effectiveness of communications as a function of the command.

The point of this introduction is to emphasize the importance of your job as a watch stander on the signal bridge. During periods of independent steaming and when the task force is not maneuvering, the watch is necessarily slow. When maneuvers begin, the pace is rapid and requires "instant response." When the OTC puts a signal in the air, the sign of a smart ship is to answer, acknowledge, and execute with minimum loss of time. A signal watch aboard a ship with a fast-maneuvering task force can be a major challenge.

This chapter describes the major responsibilities of the signal force, including lookout duties and a short discussion of forms and publications you will

use. It also discusses signals that a boatcrew Signalman must be familiar with, and explains UNREP procedures.

DUTIES OF THE WATCH

LEARNING OBJECTIVES: List and explain the duties of the signalbridge watch, including the duties of the signal supervisor, spotter, and recorder. Explain the procedures for using a maneuvering board to locate ships and to plot formations.

Frequently, the duties of Signalmen, spotters, and recorders may be rotated to better qualify strikers. When the pace is quick, however, the supervisor makes sure the best qualified personnel are in the most important spots.

SIGNAL SUPERVISOR

A Signalman 3 or 2 frequently is assigned the duties of signal supervisor. During the watch, the supervisor is in complete control of signal personnel on watch and of signal material in use, and ensures that a proper lookout is kept at all times. When the ship is under way, the signal supervisor is subject to the leading Signalman and the signal officer. The supervisor stations the watch so as best to carry on the signal activities and to attain watch discipline. The supervisor's primary concerns are with traffic handling and watch discipline, and only secondarily (as necessary) with actual operation. It is the supervisor's responsibility to make sure instructions are complied with for internal routing and filing of messages applicable to the signal section.

Any person assigned as a watch supervisor must be thoroughly familiar with *Communications Instructions, Visual Signaling Procedures*, ACP 129; *Allied Maritime Tactical Signal and Maneuvering Book*, ATP 1, volume II; *Call Sign Book for Ships*, ACP 113; *International Code of Signals*, Pub. 102, and all other applicable instructions and publications pertaining to visual communications. The supervisor should be proficient in all forms of visual

communications and be able to draft a message for transmission in any visual system. The supervisor must know the watch standers' duties in various emergency bills, with emphasis on man overboard.

During the watch, the supervisor is required to do the following:

- Ensure that an alert watch is maintained at all times.
- Coordinate and supervise operations and activities of the watch in such a way as to maintain efficiency in handling visual message traffic with minimum noise and confusion.
- Know the recognition signals that are in effect.
- Keep the watch informed of the disposition, organization, formation, and location of all units in visual company.
- Know the visual responsibility of own ship for relaying and repeating signals and messages.
- Safeguard communications publications on the signal bridge; make sure a watch-to-watch inventory is maintained.
- Conduct training and instruction for personnel on watch, as practicable, under existing operating conditions.
- Assume responsibility for cleanliness and orderliness of the signal bridge and personnel on watch.
- Acquaint the watch with the location and use of emergency signal equipment.
- Make all required reports to the bridge or quarterdeck. These reports include ships or objects sighted, status of signals on own ship and ships in the vicinity, execution of signals, and casualties to signal bridge equipment.
- Make sure receipts are obtained for messages accepted by the watch for delivery or relay.
- Maintain the visual station file and visual log.

Before becoming a Signalmen supervisor, you must complete *Personnel Qualification Standard for Visual Communications*, NAVEDTRA 43354A.

SIGNALMEN

Signalmen should be proficient in all means of visual communications and have knowledge of the following:

- Correct visual procedures, including the uses of procedure signals, procedure signs, and call signs
- Recognition procedures and recognition signals in effect
- The organization, disposition, formation, and location of all units in company
- Log and file maintenance
- Meanings of all special flags and pennants
- The location and method of operation of all emergency signaling gear

Signalmen should be able to compose and break down any visual or radio message heading in naval form. They also must know how to communicate by visual means with a merchant ship at sea and should have a basic knowledge of visual communications with aircraft.

Signalmen should pay particular attention to the following conditions:

- Keep halyards taut in fair weather. In fog or inclement weather and when it is too dark for flaghoist, slack the halyards off to prevent unnecessary strain from shrinkage
- Do not leave Irish pennants, loose equipment, or personal gear about the signal bridge
- Report lost, damaged, or inoperable equipment at once, and take steps to repair or replace it
- Keep bunting dry and covered in bad weather, and air it as often as necessary to prevent mildew. Before airing bunting, obtain permission from the senior officer present afloat (SOPA)

Signalmen must always be mindful that an alert signal force is the mark of a smart ship. The following items make for smartness in flaghoist signaling:

- Accuracy in *bending on* the correct flag the first time
- Smoothness in hoisting and making a quick turn with the uphaul
- Speed in hauling up the hoist
- Assurance that all flags are sent up clear
- Certainty that the signal is kept visible while the hoist is flying. The downhaul is kept fairly taut
- Signals are hauled down sharply, smoothly, and in such manner that they are not allowed to stream to leeward or over the side

Signalmen must be alert to respond to a flashing light or semaphore call without delay.

At night, Signalmen must use extreme care to avoid illuminating the ship's bridges and aircraft. Such illumination reduces the night visual acuity of pilots and conning officers. Whenever practicable during carrier night-flight operations, infrared (IR) systems should be used instead of visible flashing light.

LOCATING SHIPS IN FORMATION

Before you can send a visual message to another ship, you first must know where that ship is located. A Signalman with a message in hand, not knowing the location of the addressee, would be in the same plight as a postman trying to deliver a letter that has no address.

When operating with only one other ship, there is no great difficulty. Operating with a large force, however, does present a problem, and the problem becomes even more complex at night. Infrared communications during darken ship operations would be impossible without some method of keeping track of ships in the formation or locating them.

Signalmen on the signal bridge maintain an up-to-date plot of all ships in company. One of the best systems for plotting ships is a formation plot drawn on a maneuvering board. The maneuvering board itself is a compass rose with range circles, containing speed, distance, and time scales. Your only interest in the board at this time is how to use it in plotting and locating other ships in formation. You will learn more about how to solve maneuvering board problems in *Signalman*, volume II.

The different formations and their component stations are contained in *Allied Maritime Tactical Instructions and Procedures*, ATP 1, volume I. Using the formation in figure 8-1, imagine yourself as the Signalman on USS *Farragut* (DDG-37) with a message for USS *Dewey* (DDG-45).

By checking the formation plot, you find that *Dewey* is in station No. 4 and that your own station is No. 8. Place a set of parallel rulers so they intersect your station and that of *Dewey* (single dashed line in fig. 8-1). Move the parallel rulers to the center of the plot (along the paths of the double lines). Where the parallel rulers cross the outside ring of the maneuvering board is the true bearing (330°T) of *Dewey* from your ship. The formation course is 050°T,

so the relative bearing of *Dewey* is 280° (true bearing less course), or just forward of your port beam. Now that you have located the addressee, you can deliver your message.

SPOTTERS

When operating in company, spotters are stationed on the signal bridge from dawn to dark to watch for signals from the OTC and other ships in company. They must be alert at all times.

Spotters must be able to read flaghoist accurately. They call out each flag in the signal in a loud, distinct voice so that personnel on the flag bags and personnel relaying the signal to those responsible for determining the meaning of the signal can hear the signal clearly.

If the originating ship maneuvers in such a manner that its signals cannot be distinguished, the spotter should immediately inform another member of the signal force to spot the ship from another position on the signal bridge. Where there are obstructions such as smoke, haze, fouled flags, or sun glare, the spotter should be given assistance. Regardless of the effort involved or the means necessary, the signal must be obtained with minimum delay. Chapter 5, covered flaghoist terminology used by the spotter.

RECORDERS/MESSENGER

An important duty of Signalmen and strikers is to record signals and messages being read by another Signalman. The date, time of transmission or receipt, reference numbers, date-time group, means of transmission, transmitting and receiving ships, and relaying ships or stations all must be carefully recorded.

Messages are initialed by the operator and supervisor at the time of receipt or transmission. Normally, originals of nontactical messages, after being initialed, the signalbridge messenger, usually the same person that recorded the message, routes it to the OOD or captain, after which a copy is sent to the communications center for write-up and internal distribution. The method for handling tactical signals was discussed in chapter 5. *Personnel Qualification Standard for Visual Communications*, NAVEDTRA 43354A, section 301 must be completed to perform the duties of signalbridge recorder/messenger.

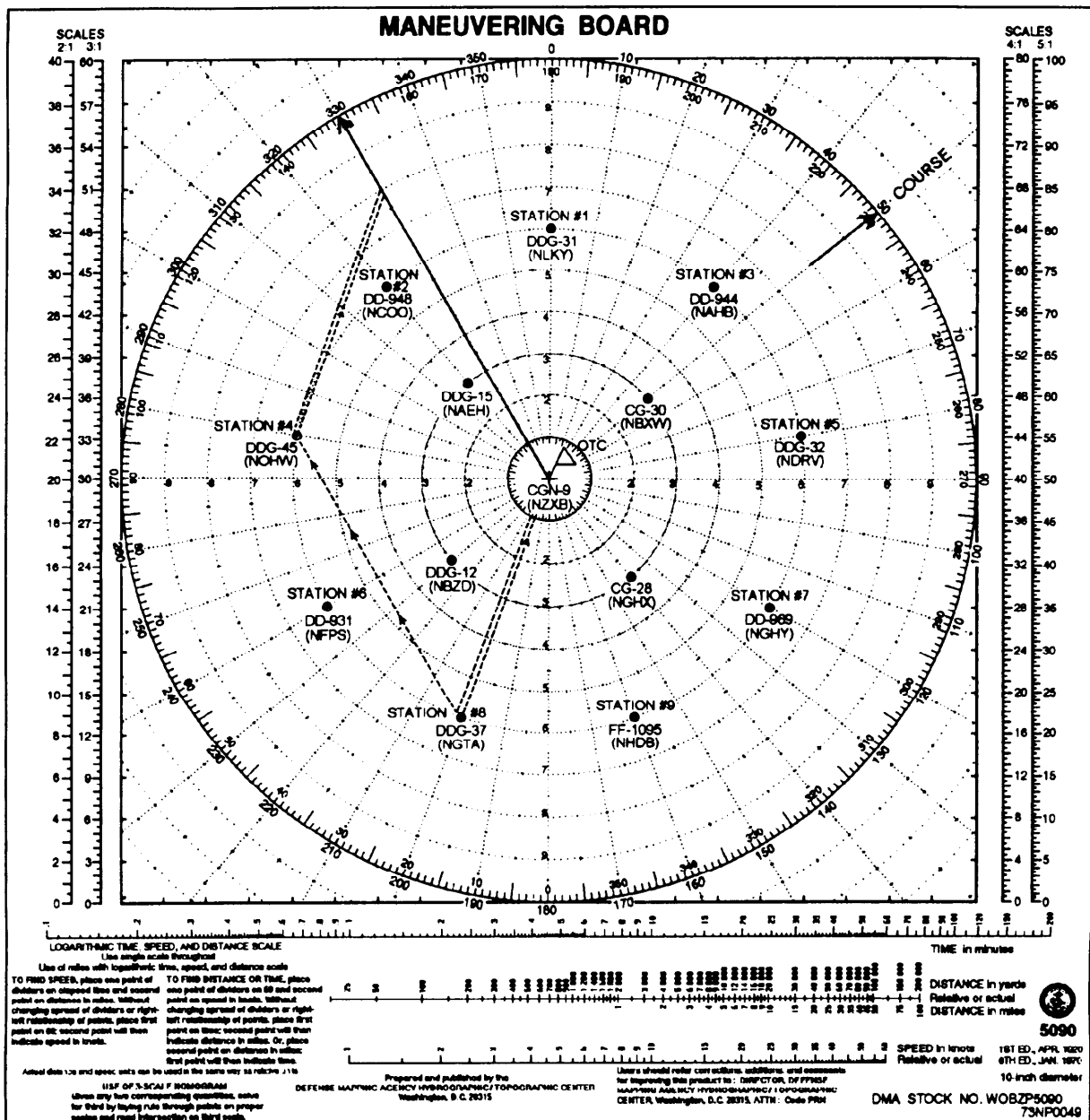

Figure 8-1.—Locating a ship by use of the formation plot.

LOOKOUT DUTIES

LEARNING OBJECTIVES: Explain the importance of maintaining a good visual lookout. Define *night vision* and *dark adaptation*.

On every ship, the lookout has an extremely important job. A Signalman's duties also require keeping a sharp lookout. **As a matter of pride, the Signalman should be the first to sight and identify objects, even on ships with an assigned lookout team.**

A good lookout has to be plenty sharp on a lot of things. Not only must lookouts be able to sight and identify objects, but they must be able to report them correctly, using relative bearings, distances, target angles, and in the case of aircraft, position angles. Report everything you observe; a normal tendency is to hesitate until you are certain an actual contact has been sighted. Do not hesitate. Many important sightings have been made on hunches.

Navy radar is the best that can be built; but there are many things that even radar cannot always detect, such as small buoys, planes low on the water, small life rafts and flares, and many other kinds of danger to navigation. There have been a number of occasions

where persons have fallen overboard and have been saved because of the timely action of a good lookout.

Also, as a Signalman, you must be familiar with the international distress signals (covered in chapter 6). Recognition of ships and aircraft, both U.S. and foreign, is another important part of your duties (covered in chapter 13).

You also have to know the different aids to navigation and their purposes; and naturally, as a Signalman, you must keep a sharp eye on the ships in company for signals. It sounds like a tough job, and if done correctly, it is. But remember, it is a part of your job, so apply yourself.

NIGHT VISION

If you were to go on night watch directly from a lighted compartment, you would be almost blind for a few minutes. As your eyes become accustomed to the weak light, your vision gradually improves. After 10 minutes you can see fairly well. After 30 minutes you reach your best night vision. This improvement of vision in dim light is called dark adaptation.

DARK ADAPTATION

Effective dark adaptation must be planned well in advance. Exposure to excessive glare during the day will hamper the ability of the eyes to adapt to the dark. This effect may last for several days if severe; therefore, you should wear sunglasses as much as possible in the daylight.

Dark adaptation before going on watch consists of spending at least 30 minutes in darkness or with the eyes protected by red goggles. Wearing red goggles is effective because red light does not affect the eyes. To complete adaptation for a night watch, spend 5 minutes on deck before relieving the watch. These 5 minutes allow your eyes to adjust to the amount of illumination in which they will work.

Once you have your night vision, be careful that you do not ruin the effect by looking into a white light. If you have to record a message or make a log entry, always use a light with a red lens. Dim red light does not spoil your night vision.

Lookout duties, and reporting procedures are discussed in the training manuals *Basic Military Requirements* and *Lookout Training Handbook*.

LOGS AND FILES

LEARNING OBJECTIVE: Explain procedures for maintaining the visual communications log, the visual station file, and the watch-to-watch inventory.

Naval Telecommunications Procedures Fleet Communications, NTP 4, requires that an accurate and complete record be maintained of all events that occur during each watch. Included in these records are visual logs, visual station files, and publications custody logs for the purpose of maintaining accurate watch-to-watch publication inventories.

VISUAL COMMUNICATIONS LOG

The visual communications log is maintained in a ledger-type record book or other bound book printed for that purpose. The visual log will contain a complete, accurate, and chronological record of all visual traffic except operator-to-operator ZWC and service messages that do not contain the prosign BT sent and received by the command.

The visual log is to be safeguarded and maintained by the watch supervisor when the visual watch is set, and by the duty Signalman or person qualified as the duty Signalman when the visual watch is not set.

Before assigning any security classification to the visual log, consult OPNAVINST 5510.1.

The visual log is retained and disposed of according to the SECNAVINST 5212.5 (Disposal of Navy and Marine Corps Records). At the minimum, the visual log must be retained for 1 month. However, the visual log may be disposed of when the ship is decommissioned provided the log does not meet any of the special criteria specified in SECNAVINST 5212.5.

Visual Log Guidelines

The guidelines for the visual log entries are based upon usages. The following guidelines do not cover every situation. For situations not covered, good judgment by the watch supervisor or duty Signalman should suffice.

- Use black ink and print legibly.
- Leave no blank spaces between lines.

- Correct errors by drawing a single line through the error and inserting personal sign.
- Close out the page at 2359Z. Begin a new page at 0001Z each day. This procedure is not applicable when visual watch is not set.
- Sign in when assuming the watch/duty. Sign out when relieved of watch/duty.
- Enter all traffic, including challenge and reply, exchanging call signs, casualties to personnel and equipment, time zone changes, day shapes, setting or securing visual watch, and any other events pertaining to visual communications.
- Use local time to indicate watches (00-04, 16-20).
- Lengthy plain language addresses denoting task organizations may be converted to special task organization call signs before entry in the visual log.
- Visual transmission abbreviations are as follows:
 - FL—Small signal searchlight
 - SL—Large signal searchlight
 - BK—Yardarm blinkers
 - NFL—Infrared directional
 - NBK—Infrared nondirectional
 - SEM—Semaphore
 - FH—Flaghoist
 - MPL—Multipurpose light

Visual Log Entries

Visual log entries will include the time of receipt/delivery and, as applicable in the case of signals, the time the signal is executed/hailed down. It will also show the method used, from whom the traffic was received, to whom the traffic was transmitted, including the originator, the action addressee(s), the information addressee(s), and the exempted addressee(s). Even though traffic is not transmitted to an exempted addressee, exempted addressee(s) must be recorded in the log. The visual log starts at the beginning of each new day, 0001Z, and ends at 2359Z. The first entry will be “assumed the watch,” and the supervisor signs in. At 2359Z, the day's log is to be closed out and the watch entries continued on the next page. All entries except the

watch identification (for example, 00-04, 04-07) are to be made in Greenwich mean time (GMT).

The last column in the visual log is used to record visual numbers. This is a convenient method of accountability. As each message is logged, it is assigned a visual number. After a message has been internally routed or, if required, relayed, it is finally placed in the visual station file and its number circled in the visual log.

No blank lines are to be left between entries in the visual log. The log is to be kept in black or blue ink. Errors must be corrected by drawing a single line through the error and relogging the correct entry. The person making the correction must initial the entry, adjacent to the correction. The visual log must be legible if it is to perform its function as a record.

All narrative entries must be logged under the Text/Remarks column. Shipboard events and evolutions recorded in other official records (for example, ship's deck log) need not be logged. Corresponding signals paralleling shipboard evolutions must be entered.

Figure 8-2 is an example of a page from a visual log. This example is not intended to cover every situation that could arise. If there is any doubt as to whether something should or should not be logged, log it. Supervisors must continually monitor the visual log to ensure that it is correct. As a general rule, the leading Signaller should check the visual log once every day.

Drills and Exercise Log

A separate log is maintained for recording visual communications drills and exercises. The format for this log is basically the same as the official log, but the log must be clearly labeled "Visual Communications Drill Log." There are no retention requirements for the drill log. Signals and messages used to begin or end drills are logged in the official log.

VISUAL STATION FILE

The visual station file contains all outgoing and incoming messages handled visually except those signal and service messages that do not contain the prosign BT. It includes either the original copy of unclassified messages or a filler for classified messages. These messages/fillers are filed in date-time-group order.

CONFIDENTIAL (When filled in)

VISUAL LOG

DATE **04 JAN 95**

TIME ZONE **+8 U**

TOP AID	TOP CAI	TOP HIO	METHOD	RECEIVED FROM	TRANS TO	OPID	ACTION ADEE	INFO ADEE	MMT ADEE	TEXT ON DATE TIME GROUP	VS NR
										BEGIN NEW 3000 DAY	
										WATCH CONTINUED	
0210	0212	0214	EH	Cp6		p05	p5	p2A		05-W-02A-1UL	
										5	
										BALL-BALL	
0246		0250	FL	Cp6		p05	Fp8			SPEED 20	
0107			FL	Rp7		Rp7	Fp8			NA	
0200										WATCH RELIEVED BY SA-ROCKS J.E. Thompson (19-29)	
0200										ASSUMED THE WATCH EMERG DL-1 st Fp8	
0210	0212	0218	EH	Fp8	Rp7	Fp8	p0p1			18Fp8-RE13-4	
0223	0225	0227	EH	Fp8	Rp7	Fp8	p0p1			18Fp8-RE13-1	
0532			NBK	Rp7	p7	Rp7	p7		Ap8	0515E (2)	
0800										WATCH RELIEVED BY SA-GRAY J.E. Thompson (24-07)	
0800										ASSUMED THE WATCH TAR0-TA99-8	
1204			FL	Rp7		Rp7	Fp8				
1500										WATCH RELIEVED BY SA-ROCKS J.E. Thompson (07-18)	
1500										ASSUMED THE WATCH 2 nd p1CE-R610-0p8-1	
1610	1612	1610	EH	Rp7		p0p1	p2CE	p2		-Cp6-Cp5-2-Fp8-Fp8	

CONFIDENTIAL (When filled in)

73NP0050

Figure 8-2.—Visual communications log (page 1 of 2).

On a flagship, if the embarked flag so desires, a separate visual station file will be maintained for flag traffic. If separate ship and flag files are maintained, many messages originated by and filed in the embarked flag's file must, if the address so indicates, also be filed in the ship's file. Duplicate filing is also required when incoming messages are addressed to both the embarked flag and the ship.

The visual station file must be classified, safeguarded, and stored according to the highest classification of its contents. The visual station file is retained and disposed of according to SECNAVINST 5212.5. The visual station files must be retained for a minimum of 30 days.

COMMUNICATIONS CENTER MASTER FILE

The communications center master file will contain a copy or filler of every message sent or

received by the center, including visual messages processed by the communications center. Messages/fillers will be filed in date-time-group order. Separate incoming and outgoing communications center master files may be maintained at the command's discretion.

CRYPTOCENTER FILE

The cryptocenter file will contain a copy of each message sent or received by the communications center that is TOP SECRET, SPECAT, or designated for special privacy regardless of classification. These messages are to be in date-time-group order, and fillers for these messages will be filed in appropriate files.

GENERAL MESSAGE FILES

General message files will contain a copy of all effective general messages that require retention

CONFIDENTIAL (When filled in)

VISUAL LOG

DATE 04 JAN 95

TIME ZONE +8 U

TOR NO	TOO CU	TOR NO	METHOD	RECEIVED FROM	TRANS TO	ORIG	ACTION ADEE	INFO ADEE	MNT ADEE	TEXT OR DATE TIME GROUP	VR NR
										(07-18)	
1575		1533	EM	ApR		ApR				R CORREN 270-12	
1549	1552	1568	EM			EpR				R	
	1552	1754	EM			EpR				BALL-DIAMOND-BALL	
	1616	1740	EM			EpR				R	
1739	1745	1754	EM			EpR				CRSP	
1845	1868	1811	EM	Cp6	Rp7	Cp6	pOpL			18706-TA91-2250	
1929	1936	1933	EM	Cp6		pOp5		Rp7		p5-W-Rp7-TA73-5-Rp7	
1940		1946	EM	Rp7		pOp1				AVL7	
	1841	1842	EM		Rp7	EpR				INT	
1842	1843	1846	EM	Rp7		pOp1				NEGAT	
1848	1850	1855	EM	Rp7		pOp1				AVL7-8-22T19	
1945	1967	1910	EM	Rp7		pOp1	7p3		ApR	703 NEGAT ApR-CNR-2	
1975	1985		EL	Cp6	ApR	Lp3	Rp2			2019153 JANGS (3)	
2043	2047	2045	EM	Rp7		pOp1				BT-CM1-EW7-	
										2 R-13-CA3-	
2047	2044	2046	EM	Rp7		pOp1	EpR			EpR-TALLIS-308-3C	
2050			EL							EXCHANGED CALL SIGNS	
										WITH MERCHANTSHP	
										BIG JOHN	
* 2051	2054	2054	EM		W474	EpR				CODE-ST	
2055	2056	2058	EM	W474		W474				8UPB	
	2058	2101	EM		W474	EpR				CODE-PP	
	2103	2104	EM		W474	EpR				ANS	
2321			EL	Cp6		pOp5	EpR			2206E	(4)
2359										END FULL DAY WATCH CONTINUED	

CONFIDENTIAL (When filled in)

73NP0051

Figure 8-2.—Visual communications log (page 2 of 2).

based on the communications center's current guard list. This file is subdivided by general message title and filed in serial number order. General message files are given the classification of the highest classified message contained within.

To learn more about the communications center master file, cryptocenter file, and general message file, you need to visit your local radio shack.

WATCH-TO-WATCH INVENTORY

The signal supervisor is responsible for all publications issued to the signal bridge. Because many of the publications are classified, they must be safeguarded. Others may be in limited supply. All are essential for efficient operation of the signal bridge. To provide positive control of communications publications, a watch-to-watch inventory similar to the one shown in figure 8-3 should be used.

At the change of each watch, the watches will jointly conduct a sight inventory of every publication. Some loose-leaf publications require a page check at the change of the watch in addition to the sight inventory. These loose-leaf publications will be specifically indicated on the watch-to-watch inventory. The signing of the watch-to-watch inventory by the relieving watch certifies that the publications were sighted, that the required page checks were conducted, and that the relieving watch stander is responsible for them. Any discrepancies noted must be resolved before the watch is relieved. All signatures must be in ink. Watch-to-watch inventories of communications publications may be destroyed after 30 days provided they are no longer required for local reference. On board ships, if an inventory is not conducted on a watch-to-watch basis, a daily inventory is required.

EMERGENCY SIGNALS

LEARNING OBJECTIVES: List and explain emergency signals for aircraft, submarines, and ships.

While on the bridge, you should be particularly alert for emergency signals in your area.

AIRCRAFT EMERGENCIES

An aircraft in distress will rock its wings initially to attract attention and to establish visual contact, and subsequently to acknowledge receipt of signals. An aircraft pilot may also rock the aircraft's wings on a

cross-wind leg to indicate that he/she is unable to take a wave-off.

The signals contained in table 8-1 may be given by pilots in emergency situations over the seas:

A ship capable of recovering an aircraft in distress will Make use of the visual signals shown in table 8-2.

Special signals used by a ship not capable of recovering an aircraft in distress are the following:

- Flashing a white *R* is used initially to confirm visual contact and subsequently to acknowledge receipt of the signal.
- Flashing a red *G* indicates that the OTC has given permission for the aircraft in distress to approach the recovery ship.

Table 8-1.—Signals from an aircraft in distress

SIGNAL	MEANING OR PURPOSE
1. Rocking wings.	Initially, to attract attention and help establish visual contact. Subsequently to acknowledge receipt of signals. On crosswind leg of landing circuits indicates inability to take a wave-off.
2. Firing RED flare.	Require emergency landing. Considered IMMEDIATE unless other information is received.
3. Firing GREEN flare.	Any early landing is necessary in the interest of safety but can orbit for a short time.
4. Series of SHORT flashes.	Require IMMEDIATE emergency landing.
5. Series of LONG flashes.	Require emergency landing but can accept short delay.
6. Fly up the port side of the ship, low and close aboard, rocking wings, in a landing configuration with hooks DOWN. Navigation lights BRIGHT & STEADY with anti-collision lights ON. If turning final in the VHF pattern or approaching final on a CCA, momentarily turn on taxi light, if available.	I desire immediate landing.
7. Fly up the port side of the ship with landing gear UP, hook DOWN, navigation lights BRIGHT & STEADY, and anti-collision light OFF while abeam the ship.	I desire to land but can wait for the next recovery.
B. Fly up the port side of the ship, rocking wings, with landing gear and hook UP, navigation lights BRIGHT & STEADY, and anti-collision light ON. If fuel state and nature of the emergency permit, continue making passes until joining by a wingman. Upon reaching BINGO fuel state, proceed alone, setting IFF/SIF to emergency when departing.	I am proceeding to the BINGO field.
9. Flashing R.	To acknowledge receipt of message.
10. (Helicopter) fly close aboard starboard quarter, remaining clear of other traffic, with gear DOWN and floodlights/landing light ON. With complete electrical failure, fire a red flare to seaward.	I require immediate landing.
11. (Helicopter) fly or hover on the starboard side of the ship, low and close aboard with navigation lights BRIGHT & FLASHING and anticollision lights ON.	I desire to land but can wait for the next recovery.

Table 8-2.—Signals from a Ship to an Aircraft in Distress

SIGNAL		MEANING AND PURPOSE	
OPTICAL LANDING SYSTEM	** ALDIS LAMP	BLINKER	
1. Flashing cut and wave off lights.	Flashing RED light.	M,M	* BINGO—to alternate landing field.
2. Flashing, cut lights.	N/A	N/A	Add power—(jets and turbo props only).
3. N/A	Steady GREEN light	C	CHARLIE—Cleared to board
4. Flashing landing area lights.	Steady RED light	D	DELTA-Delay in landing. Enter DELTA pattern and maintain visual contact with the ship.
5. Landing area lights off. (night only)	N/A	N/A	Closed deck. Do not land.
6. N/A	Z	Z	Do not land. Ditch or bail out/eject in the vicinity of the ship.
7. Steady (3 sec.) cut lights.	N/A	N/A	LSO has control of the aircraft on final approach at approximately 1 1/2 miles.
8. N/A	H	H	Lower hook.
9. N/A	W	W	Lower wheels.
10. N/A	F	F	Lower flaps.
11. N/A	G	G	Jettison disposable fuel tank.
12. N/A	Q	Q	Jettison ordinance.
OTHER			
13. Series of GREEN FLARES (day only in wartime).		Ship ready to receive aircraft for IMMEDIATE emergency landing.	
14. Series of RED FLARES.		Do not land even if previous authorization has been given.	
15. Flag: EMERGENCY FOXTROT (aircraft) EMERGENCY HOTEL (helicopter)		Have emergency landing in progress. (Aircraft not involved keep clear.)	

SUBMARINE EMERGENCIES

The following signals are prescribed for submerged submarines in emergency situations in which the submarine must come to periscope depth or surface:

- A yellow or white smoke bomb fired into the air, followed by a second yellow or white smoke bomb 3 minutes later indicates that the submarine is coming to the surface. Ships are to clear the immediate area but should not stop propellers. (White and yellow are synonymous because, under certain atmospheric conditions, white signals may appear yellow.)

- One red smoke bomb repeated as often as possible indicates “Keep clear, I am carrying out emergency surfacing procedures.”

ACP 168, *Pyrotechnic Signals*, is an excellent reference to locate the different types of pyrotechnic signals.

SURFACE SHIP EMERGENCIES

International emergency signals for surface ships are discussed in chapter 6.

For a man-overboard situation, the daytime display is the OSCAR flag, flown at the foretruck or where it can best be seen (remember, as you learned

in chapter 5, the OSCAR should always be made up for the break). When a person is lost over the side at night, the peacetime procedure is to display two flashing red lights arranged vertically. These two red lights, visible 2 miles all around the horizon, are the not-under-command lights. They are pulsed 50 to 60 times a minute by means of a crank on the light panel in the pilothouse.

In addition to the two red lights, the ship losing the person sounds, either by day or night, at least six short blasts on the ship's whistle and/or fires one white star.

Another surface ship emergency is emergency breakaway, which is covered later in this chapter.

SIGNALMAN AS A MEMBER OF THE BOATCREW

LEARNING OBJECTIVES: List and explain the duties of the boatcrew Signalman, including day and night movements, the use of the Mk 135 pyrotechnic signaling kit, and safety precautions for using the pyrotechnic kit.

One of the most important single billets you can fill in your naval career is that of boat Signalman. You will be on your own; you won't have any other Signalmen on whom to rely. The success of a particular mission depends on your ability to send and receive communications, both by visual means and by voice radio. Your ability to recognize and interpret signals will have a direct bearing on the success of that mission.

The normal boatcrew allowance does not include a Signalman; however, there will be one assigned whenever the boat is used for distress or emergency purposes.

In the event of a man overboard, a downed aircraft, or other cases where personnel are to be rescued, a Signalman is assigned to the boat. In a small boat, the range of visibility is very limited, because of the low height of eye. For this reason, other personnel are assigned to stations high in the ship to keep the person in sight. The ship can then direct the lifeboat to the vicinity of the person in the water by means of flaghoist, semaphore, flashing light, pyrotechnics, or voice radio. It is your job to receive these directions and pass them on to the boat officer and coxswain.

The emergencies that arise at sea that require a boat Signalman are many. So that you will not be found wanting in one of these emergencies, you must be familiar with all phases of visual communications and proper voice radio procedures.

DIRECTING THE BOAT BY VISUAL SIGNALS

Most boat signals are made by pyrotechnics (signal flares fired by the Mk 135 signal kit), multipurpose lights, semaphore, and flaghoist.

Vari-Color Illumination Signal Kit

The Vari-color Illumination kit (fig. 8-4) or Mk 135 is a small, lightweight unit used primarily for distress signaling. A complete kit consists of a projector and a plastic bandoleer containing three red signals, two white signals, and two green signals. An instruction sheet is included with each kit. Other combinations of signals and projectors are also available. When fired from the projector into the air, the flare burns for a minimum of 4.5 seconds at an altitude of no less than 250 feet. The signal in these kits produces a single red, green, or white star.

Operation

To operate the Mk 135, first cock the firing pin of the projector by moving the trigger screw to the bottom of the vertical slot and slipping it to the right so that it catches at the top of the safety slot. Bend the protective tab away from a signal in the bandoleer to allow removal of the signal flare. Signalmen must be familiar with the arrangement of colors in the bandoleer in the case of night operations to prevent firing of the incorrect color signal. A good practice would be to arrange the signals in the bandoleer with the green signals to starboard (right), the red to port (left), and the white in the middle.

CAUTION

The projector must not be loaded until immediately before firing. If after loading a signal it is not used, it must be removed and returned to the bandoleer.

After locating the correct color signal, mate the projector with the signal. Hold the projector over the head with the arm fully extended. The projector should

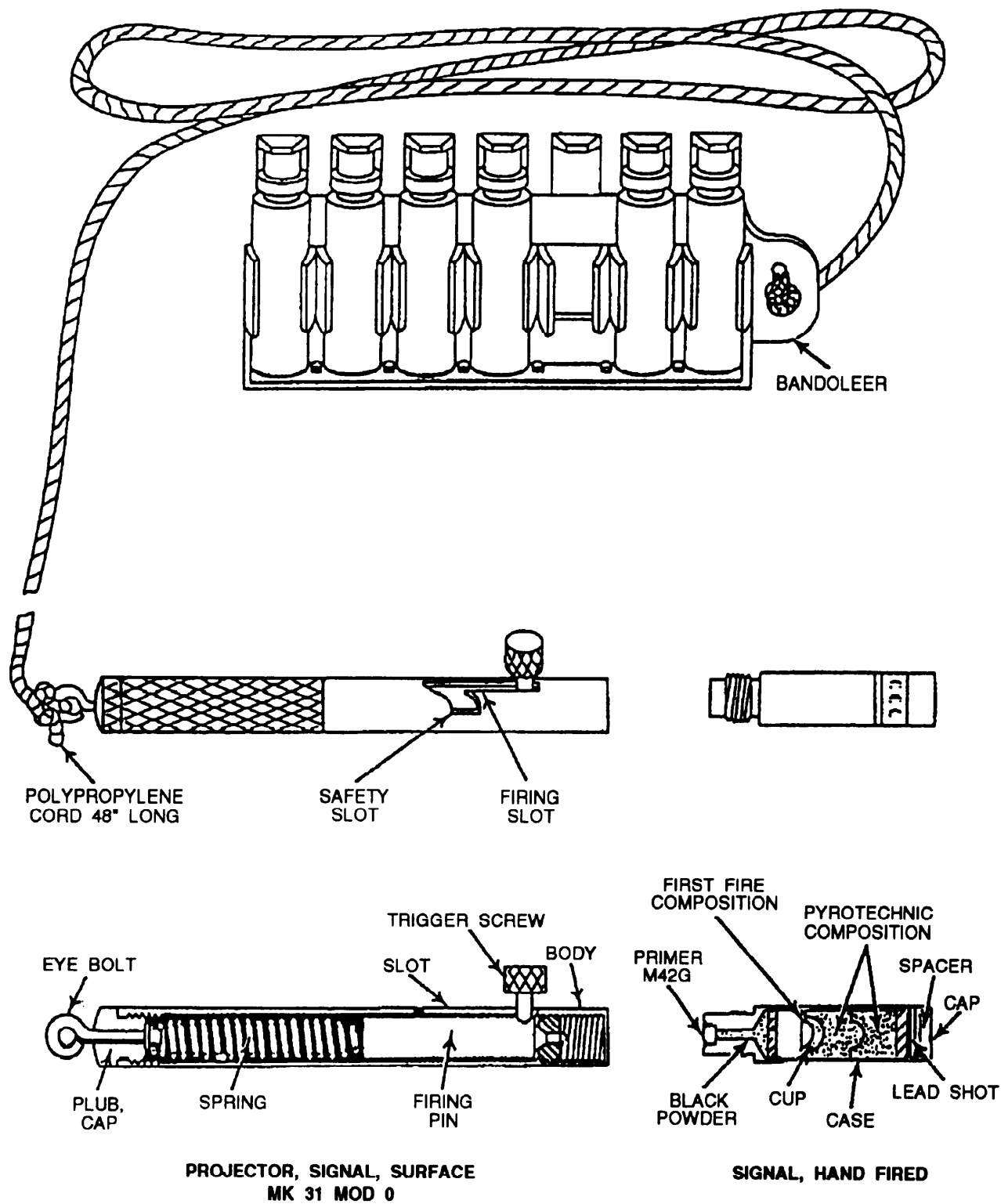

Figure 8-4.-Vari-color signal illumination kit (Mk 135).

be pointed at a slight angle to the body. While firmly gripping the projector, fire the signal by slipping the trigger screw to the left out of the safety slot and into the firing slot. If the signal fails to fire, try again by

depressing the trigger screw to the bottom of the firing slot with the thumb and releasing it quickly. Unscrew the spent signal case or a signal that has failed to fire. Discard by throwing it overboard.

The following signals are designed to direct the ship's boat during recovery operations and to help the Signalman relay information to the ship:

Ship to Boat—The following signals are given at night to direct a recovery operation:

One white star—Steer straight away from the ship

One red star—Steer left (to port)

One green star—Steer right (to starboard)

Two green stars—Steer straight toward the ship

Two red stars—Return to ship

Two white stars—Steady on present course

Boat to Ship—The following signals are nighttime boat signals used to inform the ship of the situation:

One white star—Have recovered man

One red star—Need assistance

One green star—Cannot find man

The kits are kept in a specially designed stowage box that is retained on the bridge while at sea. All signal personnel must know the exact location of the stowage box and must know how to load and fire the projector properly.

Pyrotechnic ammunition is a fire hazard. It forms a hot fire that is difficult to extinguish. Most types furnish their own oxygen upon combustion. Pyrotechnic ammunition must be protected against the direct rays of the sun, high temperatures, absorption of moisture, corrosion, and rough handling.

The signal projector's trigger screw must be checked frequently to ensure that it is tight. A loose trigger can release prematurely and cause injury. Pyrotechnic ammunition must be inspected periodically to ensure that they are not dented or corroded. Damaged signals should be reported at once to the signal officer, who will make the necessary report to the weapons officer.

Flashing Light

Table 8-3 shows ship-to-boat and boat-to-ship flashing light signals.

Table 8-3.—Flashing Light Signals.

SHIP-TO-BOAT FLASHING LIGHT "TAPS CODE"		
MEANING	SHIP	BOAT
Steer straight <u>away</u> from ship.	Flash series of 'A's.	Answer with series of 'A's.
Steer straight <u>toward</u> ship.	Flash series of 'T's.	Answer with series of 'T's.
Standby for <u>port</u> turn.	Flash series of 'P's.	Answer with series of 'P's.
Commence slow port turn.	Steady light.	Steady light.
Stop turn, steady on present course.	Drop steady.	Drop steady.
Standby for <u>stbd</u> turn.	Flash series of 'S's.	Answer with series of 'S's.
Commence slow stbd turn.	Steady light.	Steady light.
Stop turn, steady on present course.	Drop steady.	Drop steady.
Return to ship.	Flash series of 'Q's.	Answer with series of 'Q's.
BOAT-TO-SHIP FLASHING LIGHT "ARC CODE"		
MEANING	BOAT	SHIP
Need <u>assistance</u> .	Flash series of 'A's.	Flash 'RRR'.
Have <u>recovered</u> man.	Flash series of 'R's.	Flash 'RRR'.
<u>Cannot</u> find man.	Flash series of 'C's.	Flash 'RRR'.

Multipurpose Lamp

When using the portable multipurpose light (discussed in chapter 2) in a small boat, bear in mind that (1) it requires extra effort to keep the light accurately trained because of the boat's possible extreme pitch and roll, and that (2) consequently your rate of sending must be slower than normal.

Semaphore

When signaling by semaphore, use normal procedure but, again, transmit at a reduced rate of speed. If you have a poor background for sending, Signalmen on the ship may have difficulty reading your message.

Flaghoist

The following signals are used to direct a lifeboat by flaghoist:

EIGHT—Steer straight away from the ship.

EIGHT PORT—Steer left; when hauled down, cease turn and steady on present course.

EIGHT STBD—Steer right; when hauled down, cease turn and steady on present course.

EIGHT SCREEN—Steer straight toward ship.

QUEBEC—Return to ship.

Personnel Qualification Standard for Visual Communications, NAVEDTRA 43354A, section 308, must be completed before a person can be qualified as a boat Signalman.

IN-PORT DUTY SIGNALMAN

LEARNING OBJECTIVE: Explain the duties of the in-port duty Signalman.

The duties of the in-port duty Signalman range from standing a visual watch on the signal bridge to being a member of the rescue and assistance detail. Whatever your duty is, you as a Signalman must perform it to the best of your ability. Some of the duties you will perform in port are discussed in the following paragraphs.

VISUAL WATCH

Signal watches in port are normally stood between the hours of sunrise and sunset unless SOPA requires that a 24-hour visual watch be maintained.

Signalmen on watch are required to report to the OOD all ships departing and arriving in port and the movement of small boats in the harbor, and to provide the OOD with advance warning of possible passing honors.

COLORS/ABSENTEE PENNANTS

The in-port duty Signalman is responsible for hoisting and hauling down PREP for sunrise, morning, and evening colors, and frequently signals morning and evening colors by whistle.

The Signalman on watch also assures that the appropriate absentee indicator flies when the senior officers are ashore, and hauls it down when the officers return to the ship.

Semaphore and flashing light are used in port for administrative traffic. Signal watches in port are as important as those at sea. Because fewer personnel are available for each watch, a signal watch in port can be more difficult than one at sea.

Occasionally, a destroyer or smaller ship may get a tender to take its visual guard. Another possibility is that the squadron flagship may assign a rotating guard among ships in a nest. More frequently—especially aboard larger ships—each ship maintains its own visual watch in port.

Before standing the duty as an in-port duty Signalman, you must complete *Personnel Qualification Standard for Visual Communications*, NAVEDTRA 43354A, section 307.

STORM-WARNING SIGNALS

LEARNING OBJECTIVES: List and define day and night storm-warning signals.

The combinations of storm-warning flags, pennants, and light signals in figure 8-5 are hoisted or displayed at weather bureau facilities and other shore stations in the United States and its possessions to warn and indicate the severity of storms in the area. It should be noted that the four day and night storm-warning signals and their meanings are not international in their usage. The ability of a Signalman

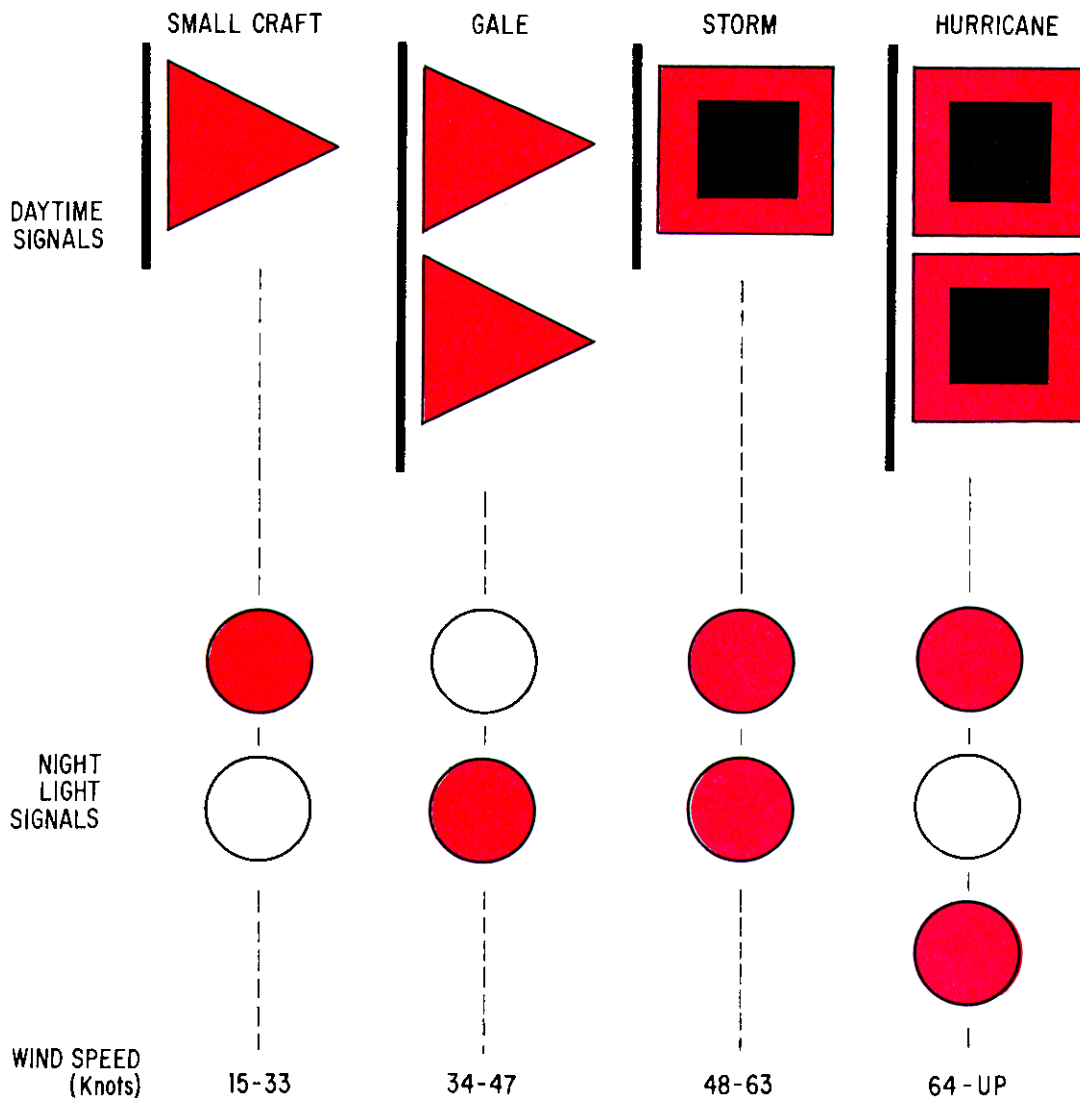

Figure 8-5.—Day and night storm-warning signals.

on watch to recognize and know the meanings of these storm-warning signals will prove invaluable to bridge personnel both in leaving and in entering port.

UNDERWAY REPLENISHMENT

LEARNING OBJECTIVES: Explain procedures for day and night underway replenishment (UNREP). List ships involved. Explain the use of flag signals, transfer station markers, distance line marker, emergency breakaway, and communications alongside.

Another part of your duties as a Signalman is to be able to communicate effectively during night and day UNREP. To be able to communicate during replenishment, you first must understand what

UNREP is all about. This section defines UNREP, including the ships involved and the day and night signals used to communicate.

Underway replenishment is a broad term applied to all methods of transferring fuel, munitions, supplies, and personnel from one vessel to another while under way.

SHIPS INVOLVED

There are usually two ships involved in an UNREP. One serves as the control and delivery ship, the other as the approach and receiving ship.

Control Ship

The control ship is normally the ship delivering the product. She maintains replenishment course and speed and normally serves as the guide.

Approach Ship

The approach ship maintains station on the control ship. The approach ship furnishes the bridge-to-bridge phone/distance line.

Delivery Ship

The delivery ship, normally the control ship, furnishes the rigs and the station-to-station phone lines.

Receiving Ship

The receiving ship, normally the approach ship, handles all phone lines.

REPLENISHMENT SIGNALS (FLAGHOIST)

Figure 8-6 shows flaghoist signals used during UNREP. These signals will be hoisted on request of the OOD.

NOTE





At night, signals must be signaled by flashing light.

REPLENISHMENT PROCEDURES (DAYTIME)

Daytime replenishment procedures include the procedures of approaching, alongside procedures, and emergency breakaway.

Approaching Procedures

The control ship steadies on course and speed and hoists ROMEO to the dip on the side rigged when preparing to receive a ship alongside and closes up ROMEO when ready to receive the approach ship.

VISUAL FLAGHOIST	
 ROMEO DISPLAYED ON FORE YARDARM ON SIDE RIGGED	<p style="text-align: center;">CONTROL SHIP</p> <p>AT THE DIP: AM STEADY ON COURSE AND SPEED AND AM PREPARING TO RECEIVE YOU ON SIDE INDICATED.</p> <p>CLOSE UP: AM READY FOR YOUR APPROACH.</p> <p>HAILED DOWN: WHEN MESSENGER IS IN HAND.</p>
 ROMEO DISPLAYED ON FORE YARDARM ON SIDE RIGGED	<p style="text-align: center;">APPROACH SHIP</p> <p>AT THE DIP: AM READY TO COME ALONGSIDE.</p> <p>CLOSE UP: AM COMMENCING APPROACH.</p> <p>HAILED DOWN: WHEN MESSENGER IS IN HAND.</p>
 PREP DISPLAYED AT THE OUTBOARD YARDARM	<p style="text-align: center;">RECEIVING SHIP</p> <p>AT THE DIP: EXPECT TO DISENGAGE IN 15 MINUTES.</p> <p>CLOSE UP: REPLENISHING COMPLETED; AM DISENGAGING AT FINAL STATION.</p> <p>HAILED DOWN: ALL LINES CLEAR.</p>
 BRAVO	<p style="text-align: center;">BOTH SHIPS</p> <p>WHERE BEST SEEN: FUEL OR EXPLOSIVES ARE BEING TRANSFERRED.</p> <p style="text-align: center;">APPROACH SHIP</p> <p>AT THE DIP: HAVE TEMPORARILY STOPPED SUPPLYING.</p> <p>CLOSE UP: FUEL OR EXPLOSIVES ARE BEING TRANSFERRED.</p> <p>HAILED DOWN: DELIVERY IS COMPLETED.</p> <p style="text-align: center;">RECEIVING SHIP</p> <p>AT THE DIP: HAVE TEMPORARILY STOPPED TRANSFERRING.</p> <p>CLOSE UP: FUEL OR EXPLOSIVES ARE BEING TRANSFERRED.</p> <p>HAILED DOWN: DELIEVERY IS COMPLETED.</p>

NOTE: AT NIGHT, ROMEO CLOSE-UP MUST BE SIGNALLED BY FLASHING LIGHT.

73NP0054

Figure 8-6.—Flaghoist replenishment signals.

The approach ship when on station and ready to make an approach on the control ship hoists ROMEO at the dip on the rigged side and closes up ROMEO when starting its approach.

The control and approach ships will display the dayshape signal for restricted movement (BALL-DIAMOND-BALL) when the approach ship closes up ROMEO. The dayshapes will be hoisted on the unrigged side or centerline and hoisted from 30 minutes prior to sunrise until 30 minutes after sunset.

Alongside Procedures

ROMEO is hauled down by both ships when the messenger is in hand.

BRAVO is closed up by both ships where best seen to indicate the transfer of fuel or explosives. BRAVO may be brought to the dip during the transfer to indicate a temporary interruption.

PREP is hoisted to the dip by the receiving ship to indicate that disengagement is expected in 15 minutes. PREP is closed up to indicate completion of replenishment and disengaging at final station. PREP is hauled down when all lines are clear.

DAYSHAPES are hauled down when each ship is clear and free to maneuver in an unrestricted manner.

Emergency Breakaway Procedures

Emergency breakaway can be initiated by either the delivery or the receiving ship. The initiated ship will hoist the emergency breakaway signal (EMERGENCY SIX). This signal is answered by all ships engaged in the emergency breakaway. Along with the flaghoist signal, the initiating ship will sound six short blasts on the ship's whistle.

Emergency signals will be passed to ships in waiting and to screen commanders.

NIGHTTIME PROCEDURES

Nighttime UNREP procedures require special equipment. The equipment is as follows:

- Signal lights fitted with screening hoods with a red filter and a 3-inch reducing diaphragm
- Infrared equipment
- Flashlights and wands
- Multipurpose lights
- Adequate supply of power sources

Approach/Alongside Procedures

The position of ROMEO is passed between the control and approach units. This is usually done by flashing light or voice radio.

PREP is passed to the control vessel, ships in waiting station, and screen commanders. Either visual or voice communication can be used, depending upon the OOD's preference.

Make sure when you are using flashing light not to train the light on the conning stations. This could blind the OOD. The use of the yardarm blinkers must be avoided.

Restricted Movement

The control ship and the approach ship will display the nighttime signal for restricted movement (special-task lights, RED over WHITE over RED) in the same manner as for the dayshapes.

TRANSFER-STATION MARKERS

Transfer-station markers are displayed to indicate the type of commodity that is being transferred at that station. Commodity being transferred by day (fig. 8-7) is indicated by a 3-foot-square piece of bunting, metal, or painted area. By night a light box (fig. 8-8) that has nine holes, each fitted with a red lens, is used.

DISTANCE MARKERS





























Distance markers on the bridge-to-bridge distance line are arranged as shown in figure 8-9. The distance line markers are used to let appropriate personnel know the distance between the approach ship and receiving ship when alongside. The daytime and nighttime use of distance markers are described in the following paragraphs.

Daytime

These markers are colored cloth, nylon-coated fabric, or painted-canvas; each is 8 inches by 10 inches; they are spaced at 20-foot intervals, from 0 to 300 feet. The markers are color coded beginning with green, followed by red for 20 feet, yellow for 40 feet, blue for 60 feet, and white for 80 feet. The cycle then repeats itself, green for 100 feet, red for 120 feet, and so forth.

Nighttime

At nighttime, two blue chemical lights are used, one on each side of the 60-, 100-, 140-, and 180-foot

COMMODITY TRANSFERRED	CODE	
	DAY 3 ft ² (91.4 cm ²) BUNTING OR PAINTED AREA	NIGHT LIGHT BOX
MISSILES	INTERNATIONAL ORANGE	 
AMMUNITION	GREEN	 
FUEL OIL	RED	 
DIESEL OIL	BLUE	 
F76	RED & BLUE TRIANGLES	 
F44	YELLOW & BLUE TRIANGLES	 
LUBE OIL	BLACK, YELLOW QUARTERS	 
FEEDWATER	WHITE	 
POTABLE WATER	WHITE WITH BLUE LETTER "P" CENTERED	 
STORES	GREEN WITH WHITE VERTICAL STRIPES	 
PERSONNEL AND/ OR LIGHT FREIGHT	GREEN WITH WHITE LETTER "P" CENTERED	 
FUEL OIL AND F44	RED/YELLOW & BLUE TRIANGLES	 
F76 AND F44	RED/BLUE & YELLOW/ BLUE TRIANGLES	 
BRIDGE-TO- BRIDGE PHONE/ DISTANCE LINE	GREEN WITH WHITE LETTER "B" CENTERED	 

73NP0055

Figure 8-7.—Transfer-station markers.

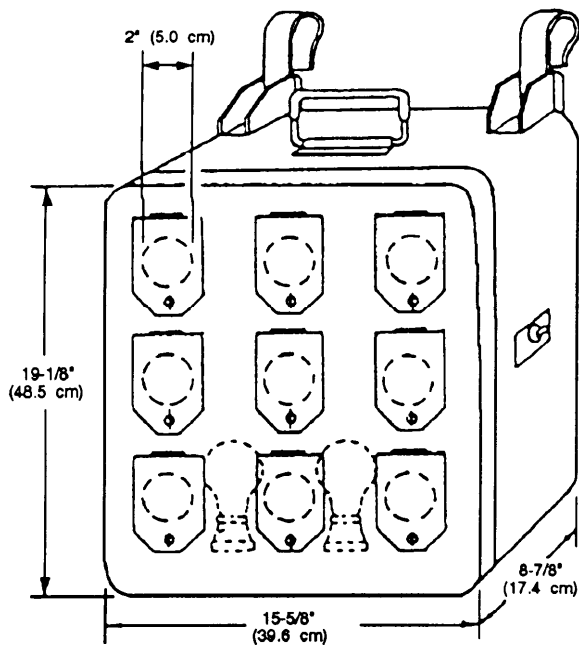

BOX HAS NINE HOLES, EACH FITTED WITH A RED LENS. HAND-OPERATED INDIVIDUAL SHUTTERS HINGE UPWARD. ILLUMINATED BY TWO 25-WATT SHIELDED BULBS (ONE IS STAND-BY).

NSN-6230-00-658-3045

73NP0056

Figure 8-8.—Station-marker light box.

markers. One red chemical light should be lashed on the approach-ship side of the other marker.

COMMUNICATIONS

Being alongside another ship is an excellent opportunity for you, as a Signaller, to sharpen your skills in semaphore and flaghoist. So when alongside, take the time to call up a striker and practice, practice, practice, or pull out those flaghoist signals you have made up in your drill log and commence exchanging signals. It's a good way to become an efficient operator. Remember, though, that before exchanging flaghoist signals, you must first request permission from the OOD.

SUMMARY

In this chapter you were taught the watchstanding duties of the Signaller. As you have read, Signaller duties cover a wide range, from locating ships in formation to recognizing the nighttime UNREP signal for ammunition. This chapter is a need-to-know for all of the Signaller community. Study and learn!

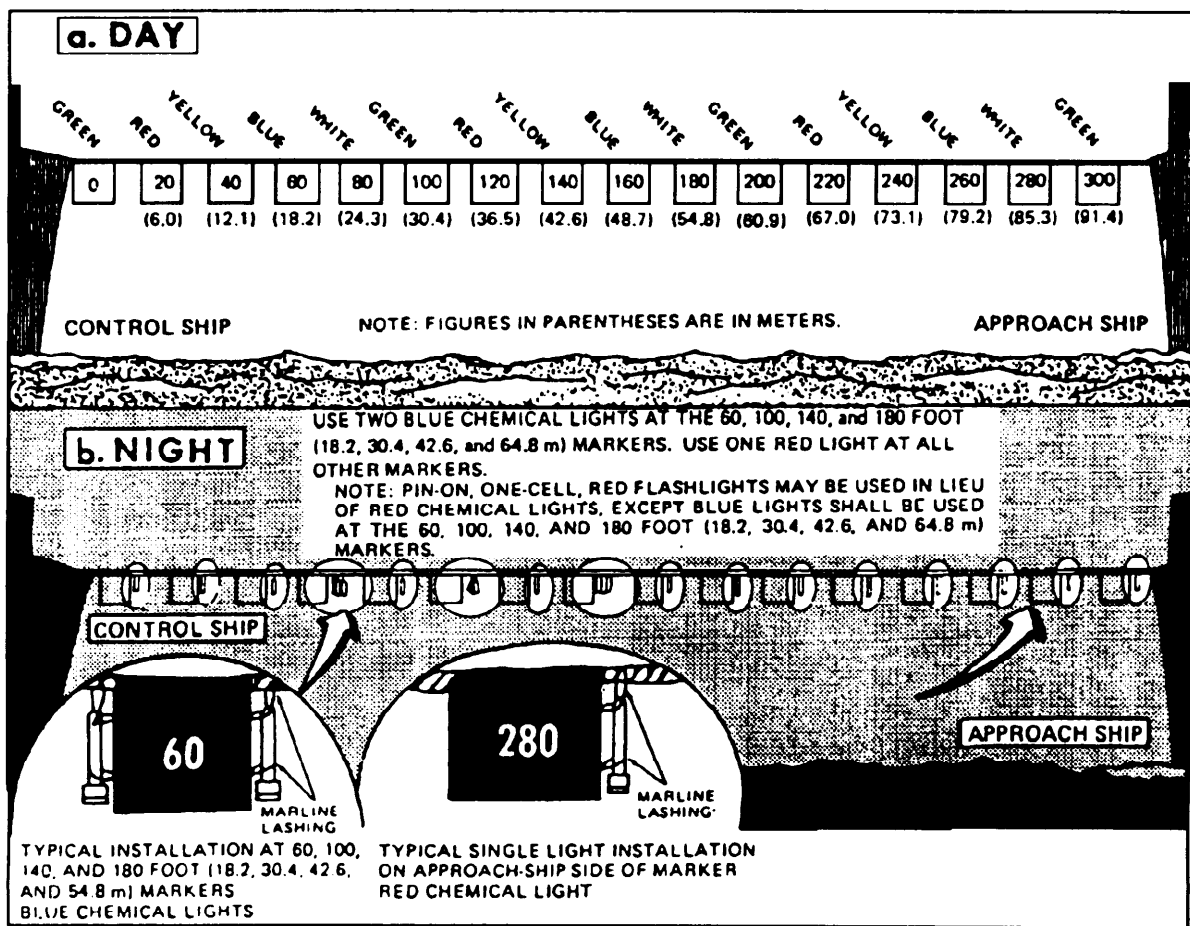

73NP0067

Figure 8-9.—Distance line markings.

CHAPTER 9

NAVIGATIONAL DUTIES

Navigation is the art or science of determining the position of a ship or aircraft and directing that ship or aircraft from one position to another. It can be regarded as an art because its application involves the exercise of special skills and fine techniques, which can be perfected only by experience and careful practice. On the other hand, navigation can be regarded as a science inasmuch as it is knowledge dealing with a body of facts and truths systematically arranged and showing the operation of general laws. Navigation has been practiced for thousands of years; however, modern methods date from the 18th century invention of the chronometer, a precision timepiece. As a Signalman, you may be required to assist the navigator by taking bearings, using the bearing circle or alidade. You may assist the officer of the deck (OOD) by sounding whistle signals and by being alert to aids to navigation.

To better prepare you for your navigational duties, this chapter contains information on navigational equipment, aids to navigation, and Rules of the Road.

NAVIGATIONAL EQUIPMENT

LEARNING OBJECTIVES: List and explain the use of navigational equipment that you will come in contact with as a Signalman.

The equipment described in this section is the equipment most likely to be used by you in performing navigational duties.

COMPASSES

There are two types of compasses in general shipboard use: the magnetic compass, which depends on Earth's magnetic field for its directive force, and the gyrocompass, which operates on the gyroscopic principle of the spinning wheel.

When you studied as a seaman, you learned that the magnetic compass points to the magnetic rather than the true North Pole, and that the magnetic pole is located some distance away from the true pole. You also discovered how the Navy standard compass is made, and how its needle is deflected by magnetic

materials either in a ship itself or by magnetic materials brought near the compass.

The gyrocompass, on the other hand, points to true north by operation of the gyroscopic principle. It may, however, have a slight mechanical error of a degree or two, which is known and for which due allowance is made.

Magnetic Compass

The ship's magnetic compasses are named or classed according to their use.

The standard compass is the magnetic compass used by the navigator as a standard for checking other compasses on the ship. It is so located that it is least affected by the internal magnetism of the ship. Courses or bearings given from it are designated per standard compass (PSC).

The steering compass is located near the helmsman. Along with the gyro repeater, it is the compass by which the ship is steered. Courses or bearings given from it are designated per steering compass (PSTCO).

Gyrocompass

The gyrocompass is not affected by variation and deviation. Headings or bearings from it are designated per gyrocompass (PGC).

When in proper running order, the gyrocompass points constantly to true instead of magnetic north. It may have a slight mechanical error, called gyro error, which is computed easily and remains constant for any heading.

Despite the excellence of the gyro mechanism, it is the magnetic compass—not the gyro—that is standard aboard ship. The reason is the magnetic compass operates through the attraction exerted by Earth. Consequently, the magnetic compass will never go out of commission because of power failure.

The gyrocompass, on the other hand, is powered by electricity. If the supply is cut off, the gyro is useless. Being an extremely complicated and delicate instrument, it is also subject to mechanical failure.

Some gyros, for instance, become erratic after the ship makes a series of sharp turns at high speeds. The possibility of a gyro malfunction does not mean, however, that great confidence cannot be placed in the gyro. When running properly, it can be depended upon to point faithfully and steadily to true north. But the magnetic compass, being more reliable, is used constantly to check the gyro's performance.

Typical shipboard installations of gyrocompasses consist of one or more master gyros, whose indications are transmitted electrically to repeaters located in conning stations, on bridge wings, and at other necessary points.

BEARING AND AZIMUTH CIRCLES

Strictly speaking, *azimuth* and *bearing* are the same in meaning: the horizontal angle that a line drawn from your position to the object sighted makes with a line drawn from your position to true north. The word *azimuth*, however, applies only to bearings of heavenly bodies. For example, it is not the bearing, but the azimuth of the Sun; and not the azimuth, but the bearing of Brenton Reef Tower.

A bearing circle is a nonmagnetic metal ring equipped with sighting devices that is fitted over a gyro repeater or magnetic compass. The bearing circle is used to take bearings of objects on Earth's surface.

The azimuth circle (fig. 9-1) is a bearing circle equipped with additional attachments for measuring

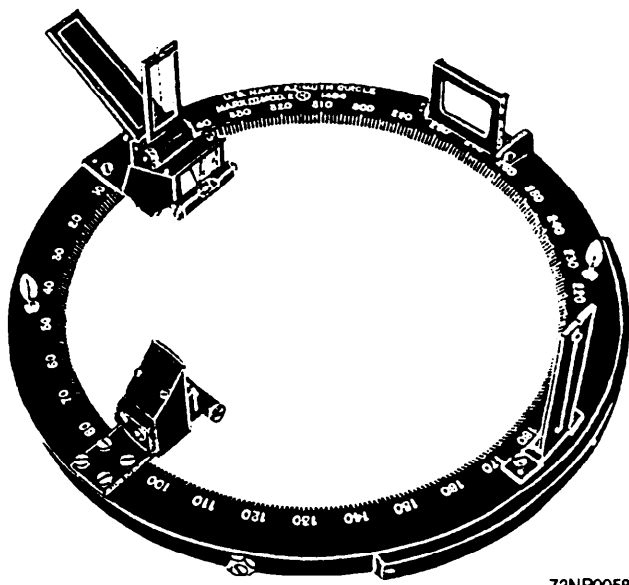

Figure 9-1.—Azimuth circle.

azimuths of celestial bodies. Either bearings or azimuths may be taken with the azimuth circle.

Taking a Bearing

Assume that you are getting a bearing on a lighthouse. Install either a bearing or azimuth circle on the gyro repeater, and make sure that the circle rotates freely. Train the vanes on the lighthouse so the lighthouse appears behind the vertical wire in the far vane. Drop your gaze to the prism at the base of the far vane, then read the bearing indicated by a hairline in the prism.

Taking an Azimuth

The azimuth circle may be used in two ways to measure the azimuth of a celestial body. The first method is used with a brilliant body such as the Sun. At the upper center in figure 9-2, you see a concave mirror; and at the lower center, a prism attachment. Sight with the mirror nearest you, and the prism toward the observed body. Light from that body is reflected from the concave mirror into the prism. The prism, in turn, throws a thin beam on the compass card. This beam strikes the graduation that indicates the azimuth.

The second method is used for azimuths of bodies whose brightness is insufficient to throw such a distinct beam. Behind the far vane on the azimuth circle is a dark glass that may be pivoted so as to pick up celestial bodies at various altitudes. When a body is sighted, its reflection appears behind the vertical wire in the far vane, and its azimuth may be read under the hairline in the prism.

The inner lip of the azimuth circle, in figure 9-2, is graduated counterclockwise in degrees. It is

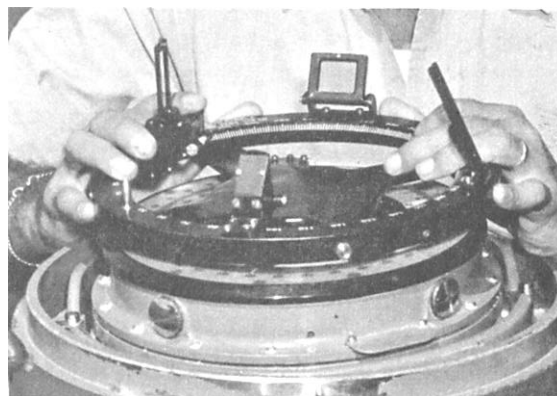

Figure 9-2.—Taking an azimuth.

possible, then, to obtain relative bearings of objects by merely training the vanes on an object, then reading the graduation on the inner circle alongside the lubber's line on the pelorus or repeater.

Each of the far vanes contains a spirit level to indicate when the circle is level. Bearings taken when the azimuth or bearing circle is not on an even keel are inaccurate.

TELESCOPIC ALIDADES

Another means of taking bearings is by using an alidade, which, like the bearing circle, is mounted on a repeater. The telescopic alidade (fig. 9-3) is merely a bearing circle with a small telescope attached to it. The image is magnified, making distant objects appear larger to the observer. A series of prisms inside the low-power telescope enables the bearing-taker to read the bearing directly from the compass card without removing the eye from the eyepiece.

Bearings and azimuths may be true, per gyrocompass (PGC), magnetic, or per steering compass (PSTCO). When you are helping the navigator in piloting, you probably will report bearings directly from the gyro repeater, and the navigator will correct them to true.

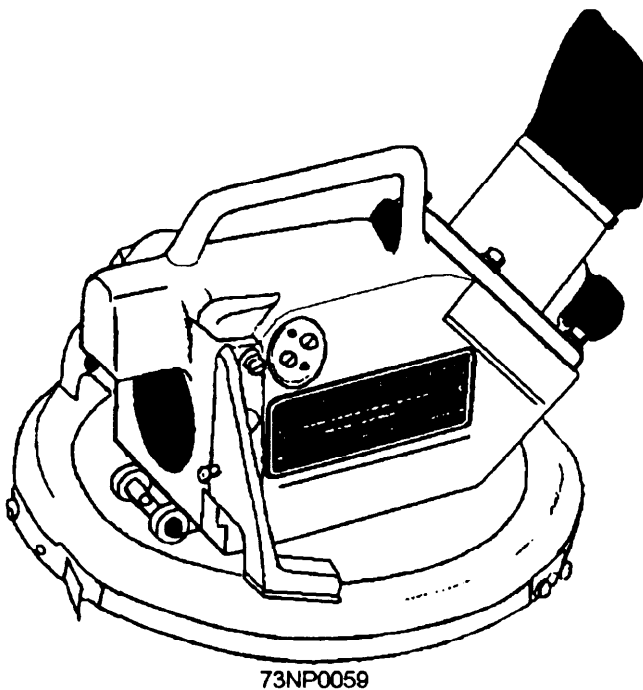

Figure 9-3.—Telescopic alidade.

CHARTS AND PUBLICATIONS

LEARNING OBJECTIVES: Explain the use of navigational charts and publications. Explain chart scales, chart sounding marks, and how to make chart corrections.

A map represents pictorially all or part of Earth's surface. Maps specially designed for navigators are called charts. Navigational charts show water depths and the nature of the bottom, together with a topography of adjacent land.

A chart is a printed reproduction of a portion of Earth's surface depicting a plan view of the land and water. A chart uses standard symbols, figures, and abbreviations that supply data on water depth, characteristics of the bottom and shore, location of navigational aids, and other information useful in navigation. Figures indicating water depth are placed throughout the water area to indicate the shape of the bottom. Normally the density of sounding on a chart increases as you approach land. A chart is normally lined with a network of parallels of latitude and meridians of longitude, which aid in locating various features.

LOCATING POSITIONS ON CHARTS

Earth is approximately an oblate (flattened at the poles) spheroid. However, for most navigational purposes, Earth is assumed to be a sphere, with the North Pole and South Pole located at opposite ends of the axis on which it rotates. To establish a feature's location geographically, it is necessary to use two reference lines, one running in a north-south direction and the other in a east-west direction. Numerical designators are applied to these reference lines. The numerical system used is circular and consists of 360°, with 60 minutes or 3,600 seconds in a degree.

Lines running in the north-south direction, called meridians, start at one pole and end at the opposite pole. (See fig. 9-4.) Lines running east-west are parallel lines and are called parallels.

Meridians

The prime (0°) meridian, which is the reference line for all meridians, passes through the Royal Observatory located at Greenwich, England. Earth is divided into Eastern and Western Hemispheres. All meridians are numbered between 0° and 180° east and west of the prime meridian. In addition to the number value, each line is identified by the letter *E* or *W*, denoting the proper hemisphere.

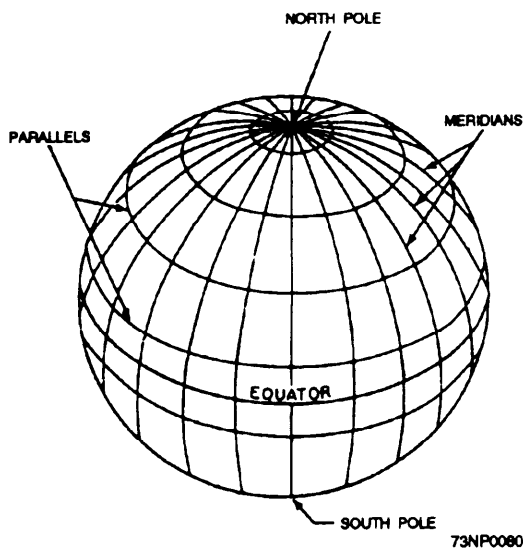

Figure 9-4.—The terrestrial sphere.

Parallels

Parallels also require a reference: the Equator. The Equator (0°) is located halfway between the poles, and divides the world into Northern and Southern Hemispheres. The letter designator (*N* or *S*) must also be used in referencing a position. The principle of the numbering system is similar to that used for meridians except that parallels range from 0° at the Equator to 90° *N* or *S* at the poles.

Latitude and Longitude

Every spot on Earth is located at the point of intersection between a meridian and a parallel. Every

point's location is describable in terms of latitude and longitude.

Latitude (parallel) is the angular position in degrees, minutes, and seconds of arc north or south of the Equator, measured along the meridian of the point. (See fig. 9-5.)

Longitude (meridians) is the angular position in degrees, minutes, and seconds of arc east or west of the 0° meridian, measured along the parallel of the point. (See fig. 9-5.)

For navigational purposes, accuracy demands are rigid. The exact position must be designated. Consequently, in giving navigational position, 1° is divided into 60 minutes, and 1 minute is divided into 60 seconds. Thus, a latitude may be $45^\circ 12$ minutes 22 seconds *N* (or *S*). The same system is used for east or west longitude. In all reports concerning navigation hazards and positions of lightships, buoys, and the like received on radio nets or read in *Notices to Mariners*, positions are given in latitude and longitude.

Nautical Distance

On Earth's surface, 1° of latitude may be considered 60 nautical miles in length; whereas the length of 1° of longitude varies with latitude. Hence, the latitude scale must be used for measuring distance. Although this scale is expanded on a Mercator chart, the expansion is exactly equal to the expansion of distance at the same latitude. Therefore, in measuring

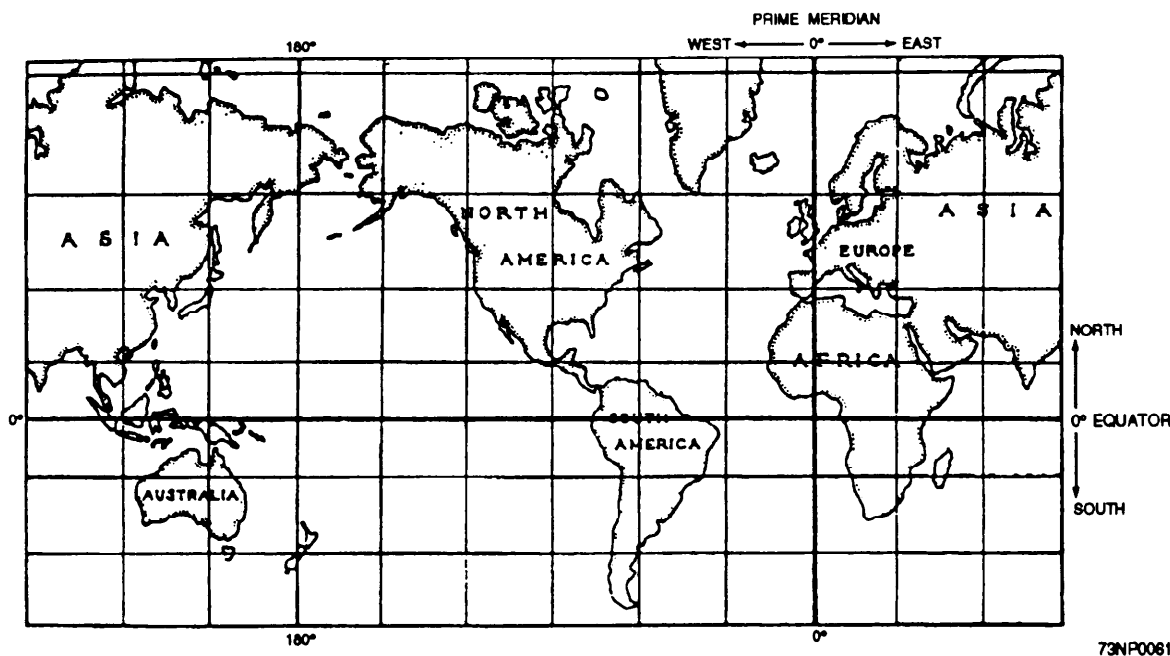

Figure 9-5.—Earth on the Mercator projection.

distance on a Mercator chart, one must be careful to use the latitude scale at the proper place.

Distance is measured by placing one end of the dividers at each end of the line to be measured and, without changing the setting of the dividers, transferring them to the latitude scale with the middle of the dividers at about the middle latitude of the two points between which the distance is desired.

TYPES OF CHARTS

Of the types of charts used today, Mercator projection charts are the most commonly used navigational charts. Other charts used include the transverse Mercator, polyconic, and gnomonic projections. For more information on the use of these charts, consult *Dutton's Navigation and Piloting* or the *American Practical Navigator*, Pub. No. 9.

CHART SCALES

The scale of a chart refers to a measurement of distance—not area. A chart covering a relatively large area is called a small-scale chart, and one covering a relatively small area is called a large-scale chart. Scales may vary from 1:1,200 for plans to 1:14,000,000 for world charts. Normally, the major types of charts fall within the following scales:

- Harbor and Approach Charts—Scales larger than 1:50,000. These charts are used in harbors, anchorage areas, and the smaller waterways. Those charts used for approaching more confined waters are called approach charts.
- Coastal Charts—1:50,000 to 1:150,000. These charts are used for inshore navigation, for entering bays and harbors of considerable width, and for navigating large inland waterways.
- General and Sailing Charts—1:150,000 or smaller. These charts are used for coastal navigation outside outlying reefs and shoals when the vessel is generally within sight of land or aids to navigation and its course can be directed by piloting techniques. They are also used in fixing the position as the ship approaches the coast from the open ocean and for sailing between distant coastal ports.

The size of the area portrayed by a chart varies extensively according to the scale of the chart. The larger the scale, the smaller the area it represents. It follows then that large-scale charts show areas in greater detail (fig. 9-6.) Many features that appear on

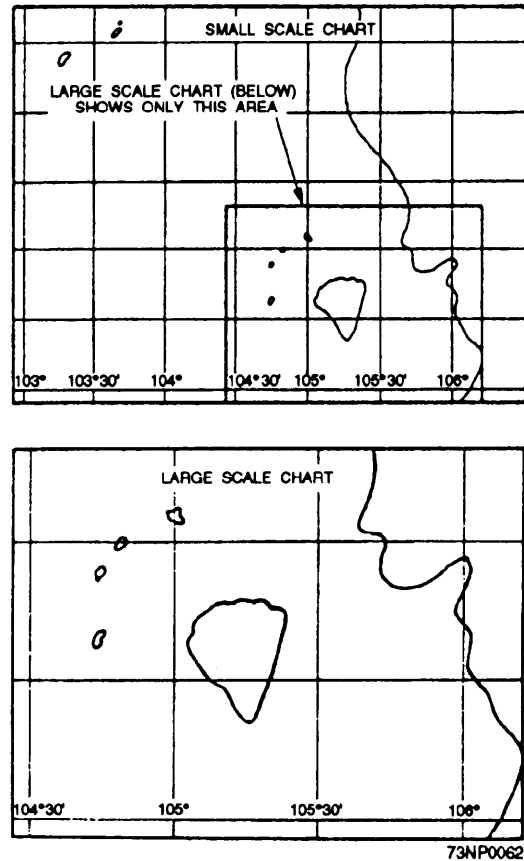

Figure 9-6.—Comparison of small- and large-scale charts.

a large-scale chart do not show up on a small-scale chart of the same area.

The scale to which a chart is drawn usually appears under its title in one of two ways: 1:25,000 or 1/25,000. These figures mean that an actual feature is 25,000 times larger than its representation on the chart. Expressed another way, an inch, foot, yard, or any other unit on the charts means 25,000 inches, feet, or yards on Earth's surface. Thus, the larger the figure indicating the proportion of the scale, the smaller the scale of the chart. A chart with a scale of 125,000 is on a much larger scale, for instance, than one whose scale is 1:4,500,000.

You must exercise more caution when working with small-scale charts than with large-scale charts. A small error, which may be only a matter of yards on a large-scale chart, could amount to miles on a chart depicting a much more extensive area. When navigating the approaches to land, use the largest scale charts available.

CHART SOUNDING MARKS

Scattered over the water area of each navigational chart are many tiny figures, as in figure 9-7. Each figure represents the depth of water in that locality. Depths on charts are shown in feet, fathoms, or meters. A notation under the title of the chart provides the key to its depth; for example, "Sounding in feet at mean low water," or "Sounding in fathoms at . . ." Most charts also contain broken lines called fathom curves, marking the limits of areas of certain depths. A 10-fathom (60-foot) curve and a 15-fathom (90-foot) curve can be seen in figure 9-7.

CHART ISSUE

Charts used in the Navy may be prepared by the Defense Mapping Agency Hydrographic/Topographic Center (DMAHTC), the National Ocean

Service (NOS), the British Admiralty, or other hydrographic agencies. Whatever the source, all charts used by the Navy are issued by the Defense Mapping Agency (DMA).

The Defense Mapping Agency (DMA) Catalog of Maps, Charts, and Related Products is a four-part catalog published by the Defense Mapping Agency Office of Distribution Services (DMAODS). It provides a comprehensive reference of all DMA maps, charts, and related products that are available for information.

NOTICES TO MARINERS

The chart and publication correction system is based on the *periodical Notices to Mariners*, published weekly by the DMAHTC to inform mariners of corrections to nautical charts and publications. This

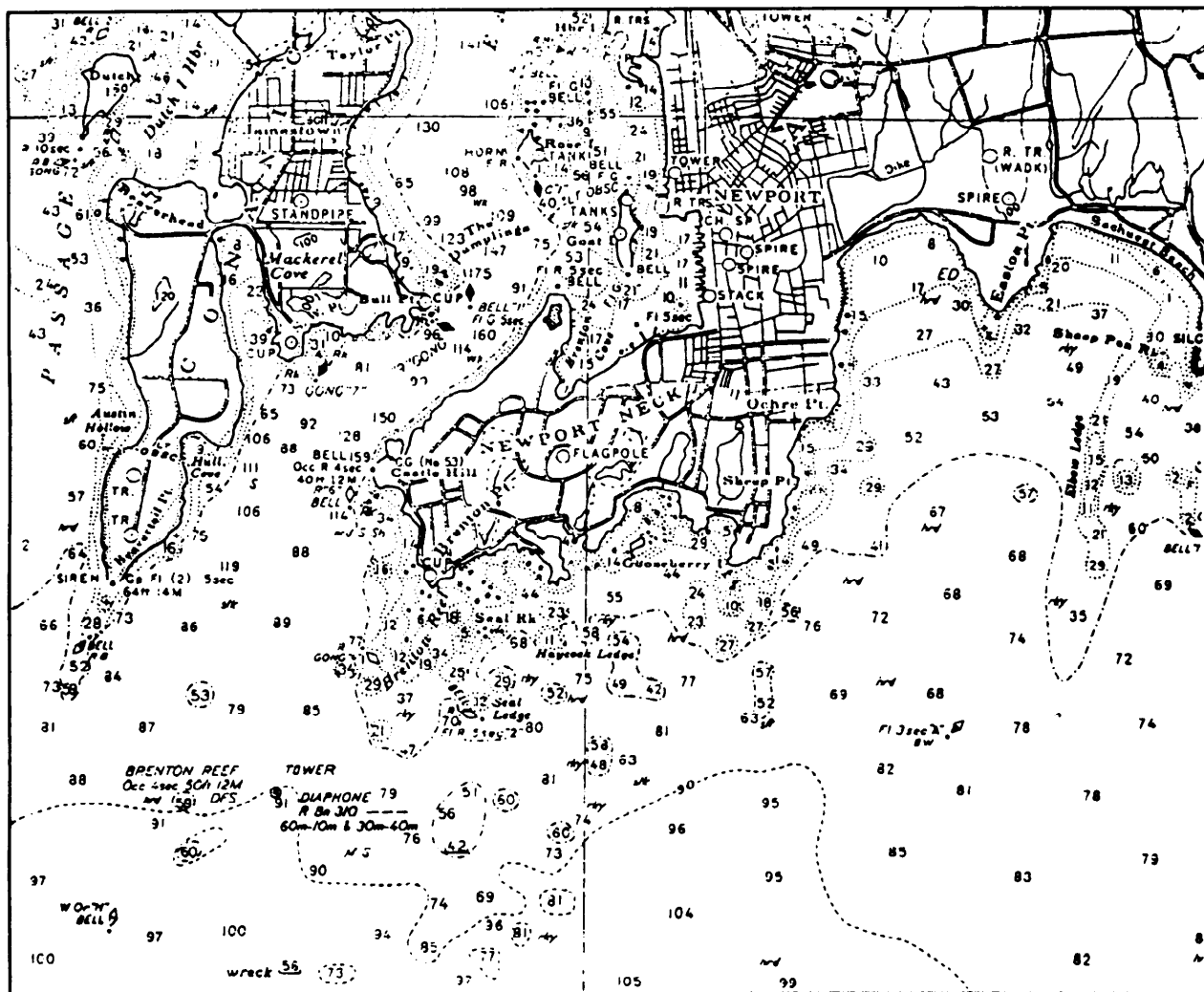

73NP0063

Figure 9-7.—Navigational chart showing depths and fathom curves.

periodical announces new nautical charts and publications, new editions, cancellations, and changes to nautical charts and publications. It also summarizes events of the week as they affect shipping, advise mariners of special warning or items of general maritime interest, and includes selected accounts of unusual phenomena observed at sea. Distribution of *Notices to Mariners* is made weekly to all U.S. Navy and Coast Guard ships and to most ships of the merchant marines.

The classified chart and publication correction system is based on *Classified Notices to Mariners*, published on an as-needed basis by the DMAHTC to inform mariners of corrections to classified nautical charts and publications.

HAND CORRECTIONS

Corrections on charts in writing should be kept clear of water areas as much as possible unless the objects referred to are on the water. When you are inserting written corrections, be careful not to obliterate any of the other information already on the chart.

When cautionary, tidal, and other such notes are to be inserted, they should be written in a convenient but conspicuous place where they will not interfere with any other details.

The year and number of each *Notices to Mariners* from which corrections have been made are to be entered in ink at the lower left corner of the chart. Temporary changes should be made in pencil. For more information on chart corrections, visit your local Quartermaster.

AIDS TO NAVIGATION

LEARNING OBJECTIVES: Identify and explain the aids to navigation, including lights, lighthouses, buoys, daybeacons, ranges, and fog signals.

In piloting, a ship's position is determined by bearings or ranges of objects whose exact location is shown on the area chart. Such objects are aids to navigation, and may be natural or man-made. Examples of natural objects are prominent hills, rocks, and mountains. Man-made objects include buildings, TV towers, and smokestacks that are coincidentally located where they can be of assistance to a navigator.

Aids to navigation are lighthouses, lightships, minor lights, buoys, and daybeacons. Aids are placed so that, insofar as possible, they provide a continuous and unbroken chain of charted marks for coast and channel piloting. Most harbors and some coasts are well marked with man-made aids to navigation, yet no attempt has ever been made to mark every mile of the world's coastline. Such marking would be impractical because many regions are seldom navigated. In some areas, the lack of artificial aids makes it necessary to use landmarks.

LIGHTS

A ship cannot suspend piloting operations when darkness falls and daytime navigational aids no longer can be seen. For this reason, aids to navigation are lighted whenever it is necessary. For purposes of identification, lights have individual characteristics regarding color, intensity, and system of operation. Some of a light's characteristics may be printed near its symbol on the chart. Detailed information, including the height—which, combined with intensity and observer's height, determines the light's visibility—is set forth in either *List of Lights* or *Light Lists*.

The DMAHTC publishes seven volumes of *List of Lights*. The volumes are divided geographically, but exclude the United States and its possessions. This list contains a description of lighted aids to navigation (except harbor-lighted buoys) and fog signals. Storm signals, signal stations, radio direction finders, and radio beacons located at or near lights are also mentioned in this list.

Lights located in the United States and its possessions are described in *Light Lists*, published by the U.S. Coast Guard.

LIGHT CHARACTERISTICS

White, red, green, and yellow are the four standard colors for lights on aids to navigation. The significance of the different colors is important chiefly with regard to channel buoys; this significance is discussed later in the sections dealing with buoys.

Some navigational lights are fixed, meaning they burn steadily. The most important lights, however, go through repeated periods of systematic changes of light and darkness. Those characteristics of a navigational light are the most valuable for

identification purposes. Figure 9-8 illustrates characteristics of lights on lighthouses and lightships.

VISIBILITY OF LIGHT

The visibility of a light is the distance in nautical miles that a navigator can expect to see the aid to navigation.

When speaking of a light, the following terms will apply:

- **Geographic range:** The maximum distance a light can be seen under conditions of perfect visibility, limited only by the curvature of Earth. It is expressed in nautical miles for the height of the observer's eye at sea level.

- **Nominal range:** Maximum distance at which a light can be seen in clear weather. Clear weather is meteorologically defined as a visibility of 10 nautical miles. Nominal range is listed for all Coast Guard listed aids except range and direction lights.

CLASS	ABBREVIATION	GENERAL DESCRIPTION	ILLUSTRATION
Fixed light	F	A continuous and steady light.	
Occulting light	Oc, Occ	The total duration of light in a period is longer than the total duration of darkness and the intervals of darkness (eclipses) are usually of equal duration. Eclipse regularly repeated.	
Group - occulting light	Oc (2), Gp Occ (2)	An occulting light in which a group of eclipses, specified in number, is regularly repeated.	
Composite group - occulting light	Oc (2 + 1), Gp Occ (2 + 1)	A light similar to a group-occulting light except that successive groups in a period have different numbers of eclipses.	
Isophase light	Iso	A light in which all the durations of light and darkness are clearly equal.	
Flashing light	F1	A light in which the total duration of light in a period is shorter than the total duration of darkness and the appearances of light (flashes) are usually of equal duration (at a rate of less than 50 flashes per minute).	
Long - flashing light	L F1	A single-flashing light in which an appearance of light of not less than 2 sec. duration (long flash) is regularly repeated.	
Group - flashing light	F1 (3), Gp F1 (3)	A flashing light in which a group of flashes, specified in number, is regularly repeated.	
Composite group - flashing light	F1 (2 + 1), Gp F1 (2 + 1)	A light similar to a group-flashing light except that successive groups in a period have different numbers of flashes.	
Quick light	Q, k F1	A light in which a flash is regularly repeated. Flashes are repeated at a rate of not less than 50 flashes per minute but less than 80 flashes per minute.	
Group quick light	Q (3), Gp F1 (3)	A light in which a specified group of flashes is regularly repeated. Flashes are repeated at a rate of not less than 50 flashes per minute but less than 80 flashes per minute.	
	Q (9), Gp F1 (9)		
	Q (6) + LF1, Gp F1 (6)		

73NP0064

Figure 9-8.—Characteristics of lights—sheet 1.

CLASS	ABBREVIATION	GENERAL DESCRIPTION	ILLUSTRATION
Interrupted quick light	IQ, Int Qk Fl	A light in which the sequence of quick flashes is interrupted by regularly repeated eclipses of constant and long duration.	
Continuous very quick light	VQ, Qk Fl	A very quick light in which a flash is regularly repeated. Flashes are repeated at a rate of not less than 80 flashes per minute but less than 160 flashes per minute.	
Group very quick light	VQ (3), Gp Fl (3)	A very quick light in which a specified group of flashes is regularly repeated.	
	VQ (9), Gp Fl (9)		
	VQ (6) + LFI, Gp Fl (6) + LFI		
Interrupted very quick light	IVQ, Int Qk Fl	A light in which the sequences of quick flashes is interrupted by regularly repeated eclipses of constant and long duration.	
Continuous ultra quick light	UQ, Qk, Fl	An ultra quick light in which a flash is regularly repeated. Flashes are repeated at a rate of not less than 160 flashes per minute.	
Interrupted ultra quick light	IUQ	An ultra quick light in which the sequence of flashes is interrupted by eclipses of long duration.	
Morse code light	Mo (U)	A light in which appearances of light of two clearly different durations are grouped to represent a character or characters in the Morse Code.	
Fixed and flashing light	FFl	A light in which a fixed light is combined with a flashing light of higher luminous intensity.	
Alternating light	Al, Alt	A light showing different colors alternately.	
Notes: 1. Alternating lights may be used in combined form with most of the previous classes of lights.		2. The second abbreviation shown for a light if any, is alternate U.S. usage.	

73NP0065

Figure 9-8.—Characteristics of lights—sheet 2.

- **Luminous range:** Maximum distance at which a light can be seen under the existing visibility conditions. It depends only on the intensity of the light itself and is independent of the elevation of the light, the observer's height of eye, or the curvature of Earth. It should be noted that luminous range and nominal range are equal with a meteorological visibility of 10 nautical miles.

- **Computed visibility:** Determined for a particular light, taking into account its elevation, intensity, height of eye of the observer, and the curvature of Earth.

- **Computed range:** The geographic range plus the observer's distance to the horizon based on the observer's height of eye.

LIGHTHOUSES AND LIGHT STRUCTURES

Lighthouses are numerous on all the coasts of the United States, on the Great Lakes, and along many interior waterways. They are placed wherever a powerful light may be of assistance to navigators, or wherever a danger requires a warning beacon of long-range visibility. Visibility increases with height;

thus, the principal purpose of a light structure is to increase the height of a light above sea level.

NOTE

Remember that a light placed at a great elevation is more frequently obscured by clouds, mist, and fog than one near sea level.

A lighthouse may also contain fog signaling and radio beacon equipment. In lighthouses still staffed by keepers, the lighthouse may also contain their quarters, or the operating personnel may be housed in separate buildings grouped around the tower. Such a group of buildings is called a light station. Many lights formerly operated by keepers are now automatic.

Secondary, minor, and automatic lights are located in structures of various types. Those structures range from towers that resemble those of important seacoast lighthouses to such objects as a small cluster of piles supporting a battery box and lens.

Solid colors, bands, stripes, and other patterns are applied to lighthouses and light structures to make them easier to identify. Lighthouses and light structures may also be painted in contrasting colors and various patterns to their background. (See fig. 9-9.) Minor structures sometimes are painted red or black, like channel buoys, to indicate the side of the channel on which they are located.

LIGHTSHIPS

A lightship is a floating lighthouse located where conditions make it impossible or impractical to build a permanent structure.

Lightships in U.S. waters are painted red on the hull, with the name of the station in large white letters on either side. Other parts of the lightship that are painted include the following: superstructure is white; mast, ventilators, lantern galleries, and stacks are buff.

The lights, fog signals, and radio beacon signals on lightships are given various characteristics for purposes of identification. Like lighthouses, lightships are described briefly on the charts and in detail in *Light Lists*.

A lightship under way or off station hoists the international code signal "LO." This indicates that the lightship is not in the correct position. The lightship

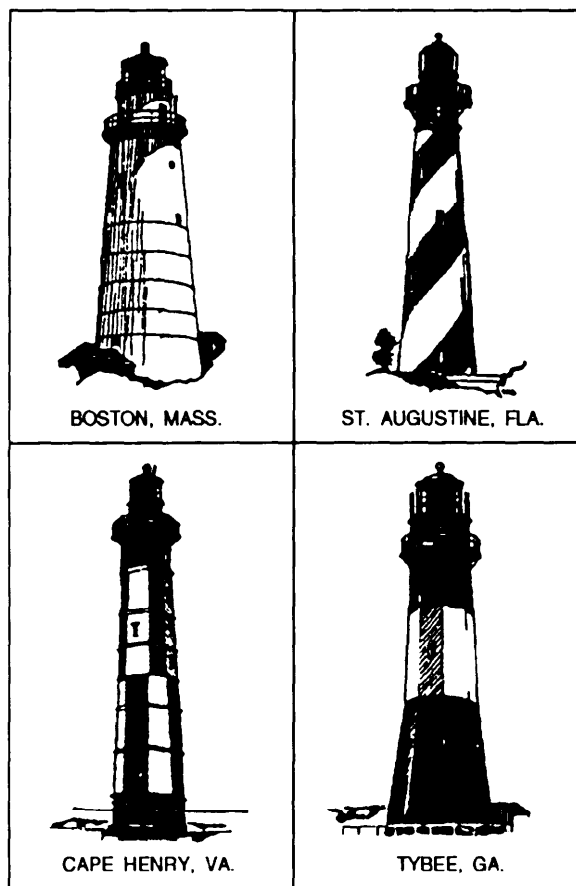

73NP0066

Figure 9-9.—Various patterns of typical lighthouses.

must then observe the requirements of the Rules of the Road for a vessel of that class.

At night when anchored on station, a lightship shows only its beacon light and a less brilliant light on the forestay to indicate the heading.

When a regular lightship goes in for overhaul or repairs, the lightship's place is taken by a relief lightship whose lights and signals have, as nearly as possible, the same characteristics as the ship she replaces. Relief lightships are distinguished by the word *RELIEF* painted in white on either side.

SECTOR LIGHTS

Sectors of red glass are placed in the lanterns of certain lighthouses to indicate danger bearings, within which a ship will be in danger of running onto rocks, shoals, or some other hazard. The arcs over which the red light shows are the danger sectors whose bearings appear on the chart. Although the light is red within the danger bearings, its other characteristics remain the same.

Sectors may be only a few degrees wide, marking an isolated obstruction, or they may be so wide as to extend from the direction of deep water to the beach. A narrow green sector may indicate a turning point or the best water across a shoal. The exact significance of each sector must be obtained from the chart.

All sector bearings are true bearing in degrees, running clockwise around the light as a center. In figure 9-10, for instance, the bearings of the red sectors from the light are 135° to 178° . This sector is defined in *Light Lists* in terms of bearings from the ship. These bearings are 315° to 358° , the reciprocals of the preceding bearings. The light shown in the diagram would be defined thus: Obscured from land to 315° , red thence to 358° , green thence to 050° , and white thence to land.

On either side of the line of demarcation between colored and white sectors, there is always a small sector whose color is doubtful because the edges of the sector cannot be cut off sharply in color. Moreover, under some atmospheric conditions a white light itself may have a reddish appearance. Consequently, light sectors must not be relied upon entirely, but position must be verified repeatedly by bearings taken on the light itself or by other fixed objects.

When a light is cut off by adjoining land, the arc of visibility may vary with a ship's distance away from the light. If the intervening land is sloping, for example, the light may be visible over a wider arc from a far-off ship than from one close inshore.

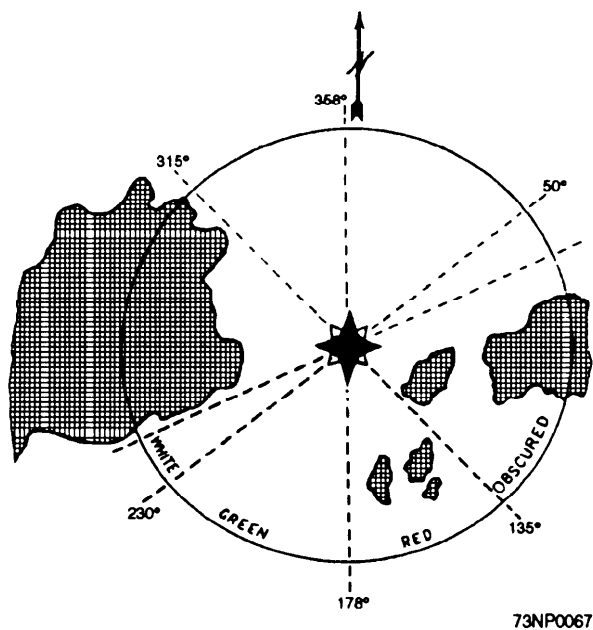

Figure 9-10.—Light sectors.

BUOYS

Buoys are perhaps the most numerous aids to navigation, and they come in many shapes and sizes. These floating objects, heavily anchored to the bottom, are intended to convey information by their shapes or color, or by the characteristics of a visible or audible signal, or by a combination of two or more of such features.

Large automatic navigational buoys (LANBY) are major aids to navigation. They provide light, sound signal, and radio beacon services, much the same as a lightship. Some LANBYs today are replacing lightships in U.S. waters. The LANBY is an all steel, disc-shaped hull, 40 feet in diameter. The light, sound signal, and radio beacon are located on the mast.

Although buoys are valuable aids to navigation, as was stated for sector lights, they must never be depended upon exclusively. Buoys frequently move during heavy weather, or they may be set adrift when run down by passing vessels. Whistles, bells, and gongs actuated by the sea's motion may fail to function in smooth water, and lights on lighted buoys may burn out.

MARITIME BUOYAGE SYSTEM

Until recently, there were numerous buoyage systems in use around the world. In 1982, most of the maritime nations signed an agreement sponsored by the International Association of Lighthouse Authorities (IALA). This agreement adopted a system known as the IALA Maritime Buoyage System. Two systems were developed because certain basic long-established international differences precluded adoption of a single system worldwide. Both systems, designated region A and region B, use a combination of cardinal marks and lateral marks plus unique marks for isolated danger, safe-water areas, and special purposes. The cardinal and unique marks are the same in both systems; the lateral marks are the major difference between the two buoy regions.

To convey the desired information to the navigator, the IALA system uses buoy shape, color, and if lighted, the rhythm of the flashes. Buoys also provide for a pattern of "topmarks," small distinctive shapes above the basic aid, to facilitate its identification in the daytime from a distance, or under light conditions when the color might not be easily ascertained. Figure 9-11 show the international buoyage regions A and B.

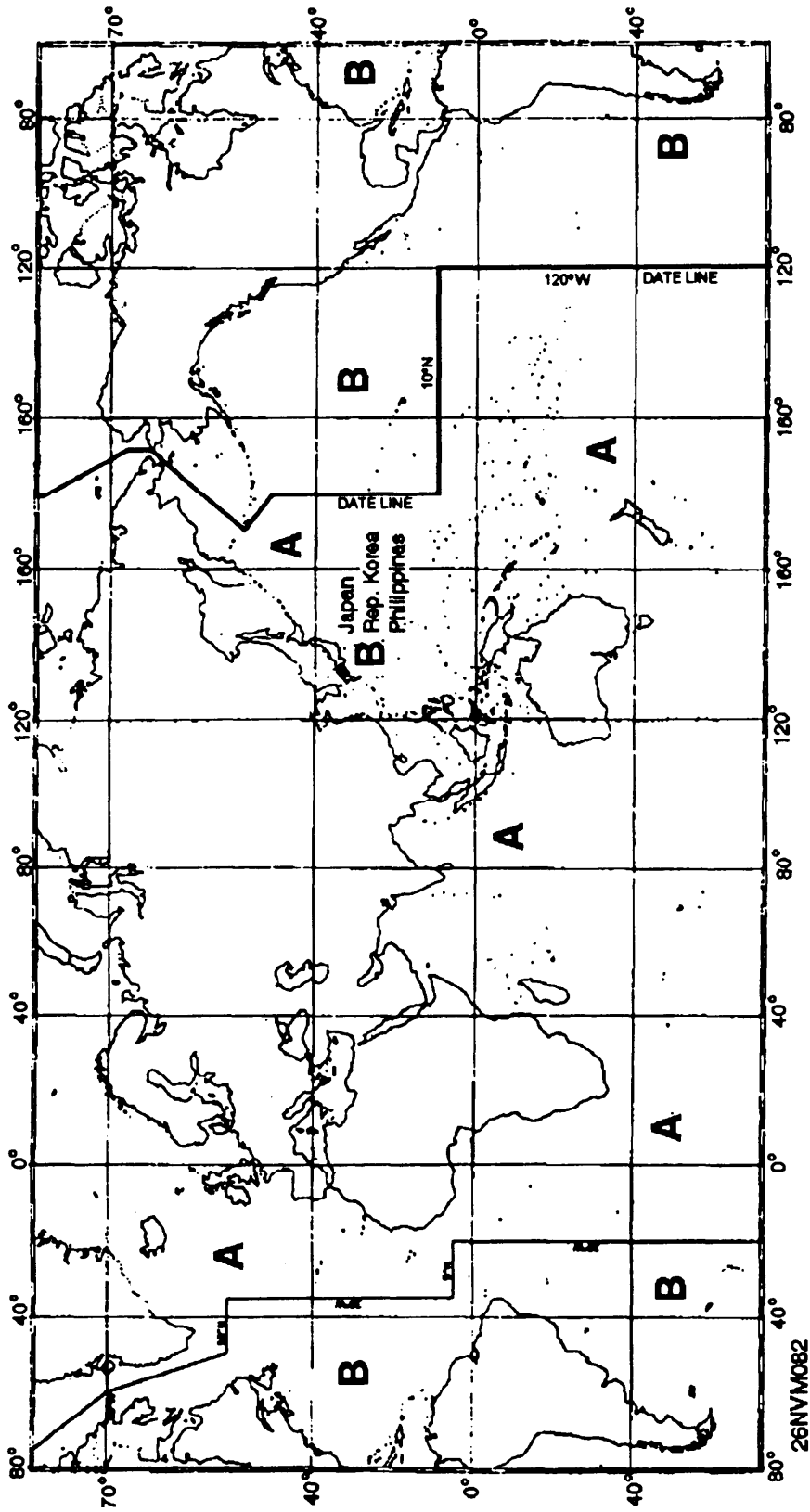

Figure 9-11.—IALA Maritime Buoyage System, buoyage regions A and B.

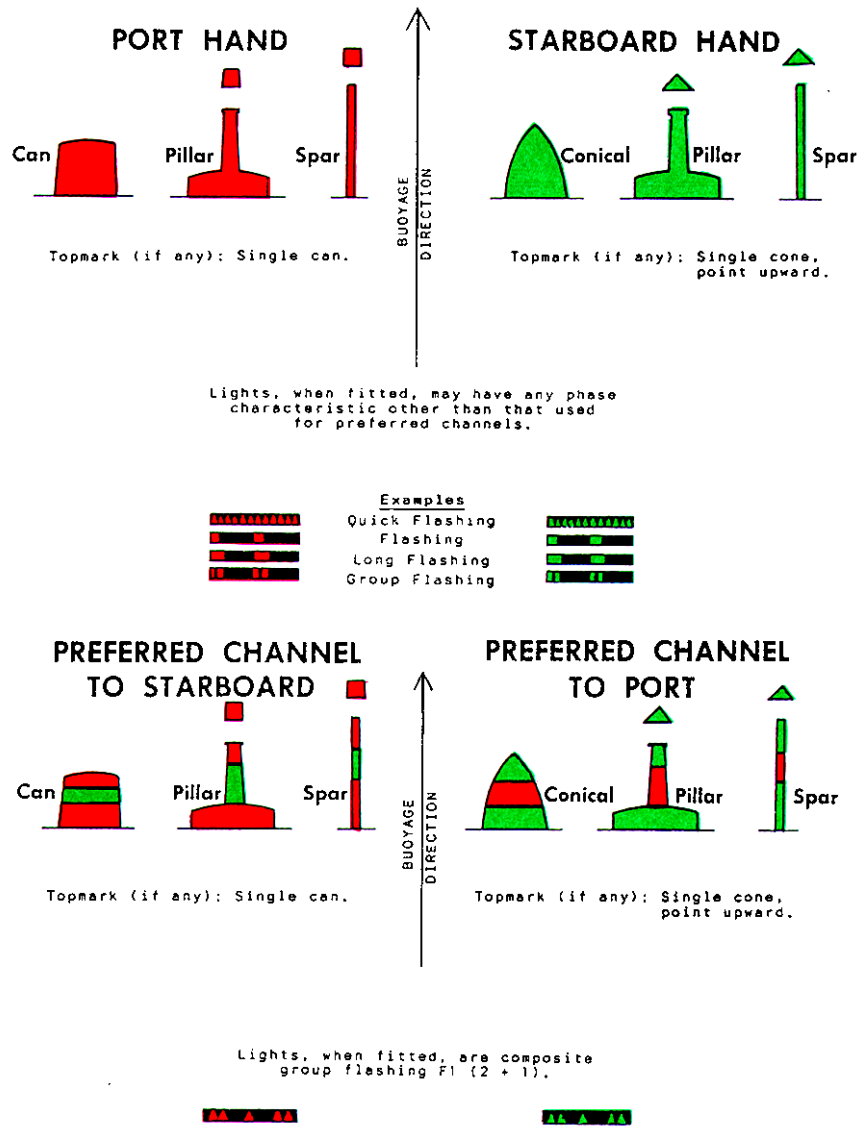

Figure 9-12.—IALA Maritime Buoyage System lateral marks, region A.

Region A

Region A (fig. 9-12) is used in Europe, Africa, and most of Asia, including Australia and New Zealand. The major rule to remember when using region A is that the lateral mark will be red buoys to port and green buoys to starboard when entering from seaward.

Region B

Region B (fig. 9-13) is used in North, Central, and South America, plus Japan, South Korea, and the Philippines. The rule to remember when using region B is the exact opposite from using region A: Lateral marks will be red to starboard and green to port when entering from seaward.

Types of Marks

The Maritime Buoyage System provides five types of marks, which may be used in any combination.

1. Lateral marks—indicate the port and starboard hand sides of channels.
2. Cardinal marks—used in conjunction with the compass, indicate that the navigable waters lie to the named side of the mark.
3. Isolated danger marks—erected on, or moored directly on or over, dangers of limited size.
4. Safe water marks—used to indicate there is safe water for navigation all around the position (example: midchannel).

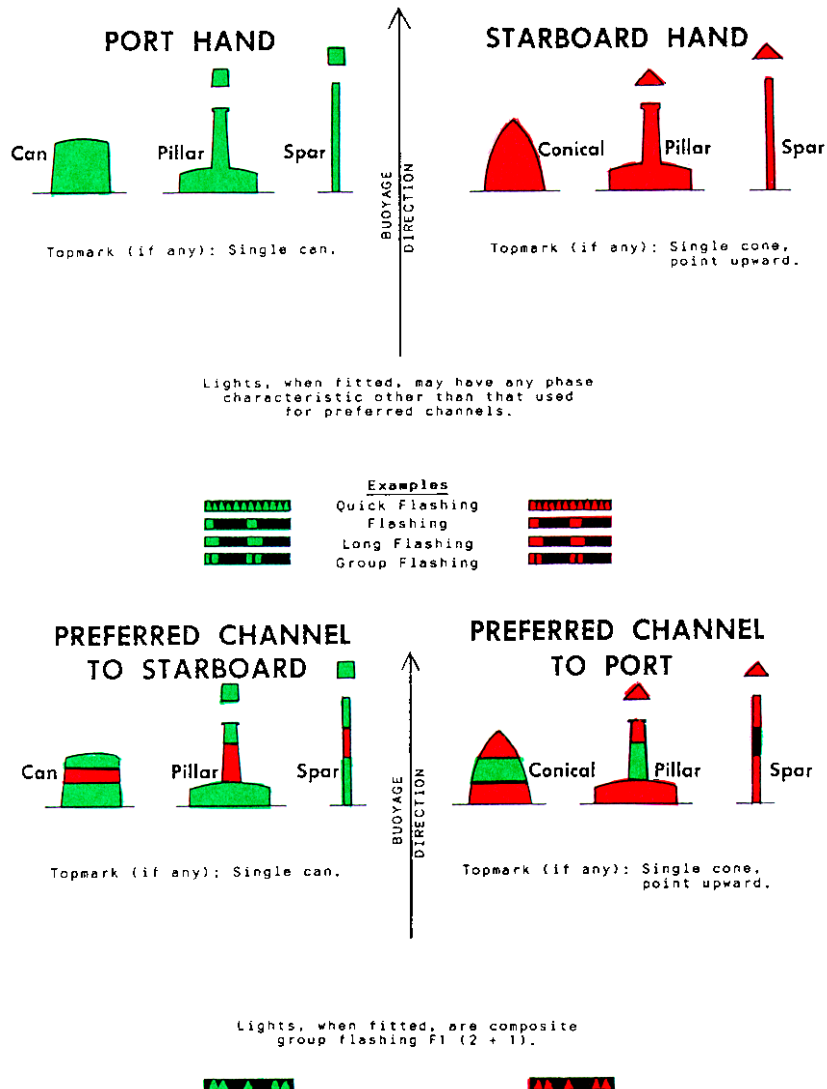

Figure 9-13.—IALA Maritime Buoyage System lateral marks, region B.

5. Special marks—call attention to an area or specific feature. Explanation of special marks may be found on *the chart* or in *Sailing Directions* or *Coast Pilots*.

Distinguishing Marks

The meaning of distinguishing marks depends upon one or more of the following features:

- By day—color, shape, and topmark
- By night—light color and phase characteristics

Buoy Shape

There are five basic buoy shapes (fig. 9-14): the can, nun, spherical, pillar, and spar. With the exception of the pillar and the spar buoys, the shape of the buoys indicates the correct side on which to pass. Can buoys

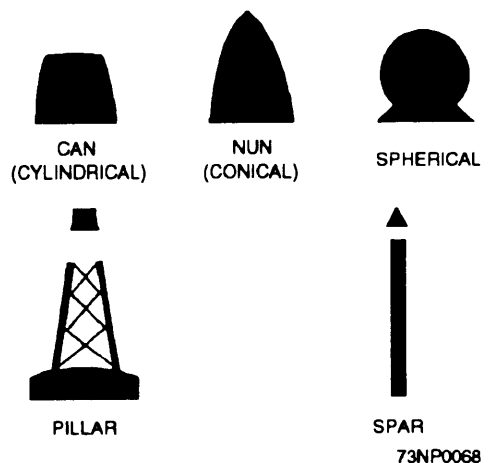

Figure 9-14.—Types of buoys.

are sometimes referred to as cylindrical buoys and nun buoys are referred to as conical buoys. The term *pillar*

is used to describe any buoy that is smaller than a lighthouse buoy and has a tall, central structure on a broad base. Lighted buoys in the United States are referred to as pillar buoys.

Topmarks

The IALA Maritime Buoyage System makes use of can, nun, spherical, and X-shaped topmarks only. Topmarks on pillar and spar buoys are particularly important to indicate the side on which they will be passed and will be used, whenever practical.

Lights

Where marks are lighted, red and green lights are reserved for port and starboard or starboard and port lateral marks. Yellow lights are for special marks, and white lights are used for other types that will be discussed later in this chapter.

Buoy Color

Under region B of the IALA system, red buoys mark the starboard side of the channels, or the location of wrecks or obstructions that must be passed by keeping the buoy on the starboard (right) hand when returning from sea. Green buoys mark the port side of the channels, or the location of wrecks or obstructions that must be passed by keeping the buoy to port (left) hand when returning from sea.

Red and green horizontally banded buoys are used to mark obstructions and channel junctions. They may be passed on either side, but sometimes the channel on one side is preferable. If the top band on the buoy is red, the preferred channel will be followed by keeping the buoy to starboard. If the top band is green, the preferred channel will be followed by keeping the buoy on the port. However, in some instances it may not be feasible for larger vessels to pass on either side of such a buoy, and the chart should always be consulted. The colors indicated above would be reversed for the region A buoy system.

Red and white vertically striped buoys are “safe-water marks,” used to indicate the mid-channel, a fairway, or a landfall. These buoys are also used at the beginning of some vessel Traffic Separation Schemes at the entrances to busy ports, or in narrow passages congested with heavy traffic.

Solid yellow buoys are special-purpose buoys typically marking anchorage, fishnet areas, and dredging sites. These buoys have no lateral system

significance; but as most are shown on charts, they can often serve to assist in determining one's position. Solid yellow buoys can be any shape.

Buoy Numbering

Most buoys are given numbers, letters, or combinations of numbers and letters, which are painted conspicuously on them or applied in white retroreflective material. These markings facilitate identification and location of the buoys on the chart.

Solid red or green buoys are given numbers or combinations of numbers and letters. Other colored buoys are given letters. Odd numbers are used only on solid green buoys; even numbers, on solid red. Numbers increase sequentially from seaward; numbers are sometimes omitted when there are more buoys of one type than another.

DAYBEACONS/DAYMARKS

Where daybeacons are substituted for unlighted buoys, the color of the daymark will be the same and the shape similar. Red daymarks will be triangular, approximating the shape of the top of a nun buoy. Square daymarks, corresponding to can buoys, will be green.

Daymarks equivalent to spherical buoys are octagonal. The daymarks on a daybeacon replacing a yellow special-purpose buoy are diamond-shape.

Daybeacons will be numbered or lettered with retroreflective material in the same manner as a buoy and will have a border of that material. Many have panels of red and green reflective material. Some channels may be marked with a combination of buoys, daybeacons, and lights.

LATERAL MARKS

Lateral marks are generally used for well-defined channels. They indicate the route to be followed and are used in conjunction with a conventional direction of buoyage. This direction is defined in two ways, as follows:

Local direction of buoyage—The direction taken by a mariner when approaching a harbor, river estuary, or other waterway from seaward

General direction of buoyage—In other areas, a direction determined by the buoyage authorities, following a clockwise direction around continental

landmasses given in *Sailing Directions*, and, if necessary, indicated on charts by a symbol

CARDINAL MARKS

A cardinal mark is used in conjunction with the compass to indicate the best navigable water. It is placed in one of four quadrants (north, east, south, or west) from the best water. A cardinal mark takes its name from the compass point in which it is placed. Figure 9-15 shows the IALA Maritime Buoyage System cardinal marks.

The mariner is safe if he/she passes north of a north mark, east of an east mark, south of a south mark, and west of a west mark. A cardinal mark may be used to do the following:

- Indicate that the deepest water is an area on the named side of the mark.
- Indicate the safe side on which to pass a danger.
- Draw attention to a feature in a channel, such as a bend, junction, branch, or end of a shoal.

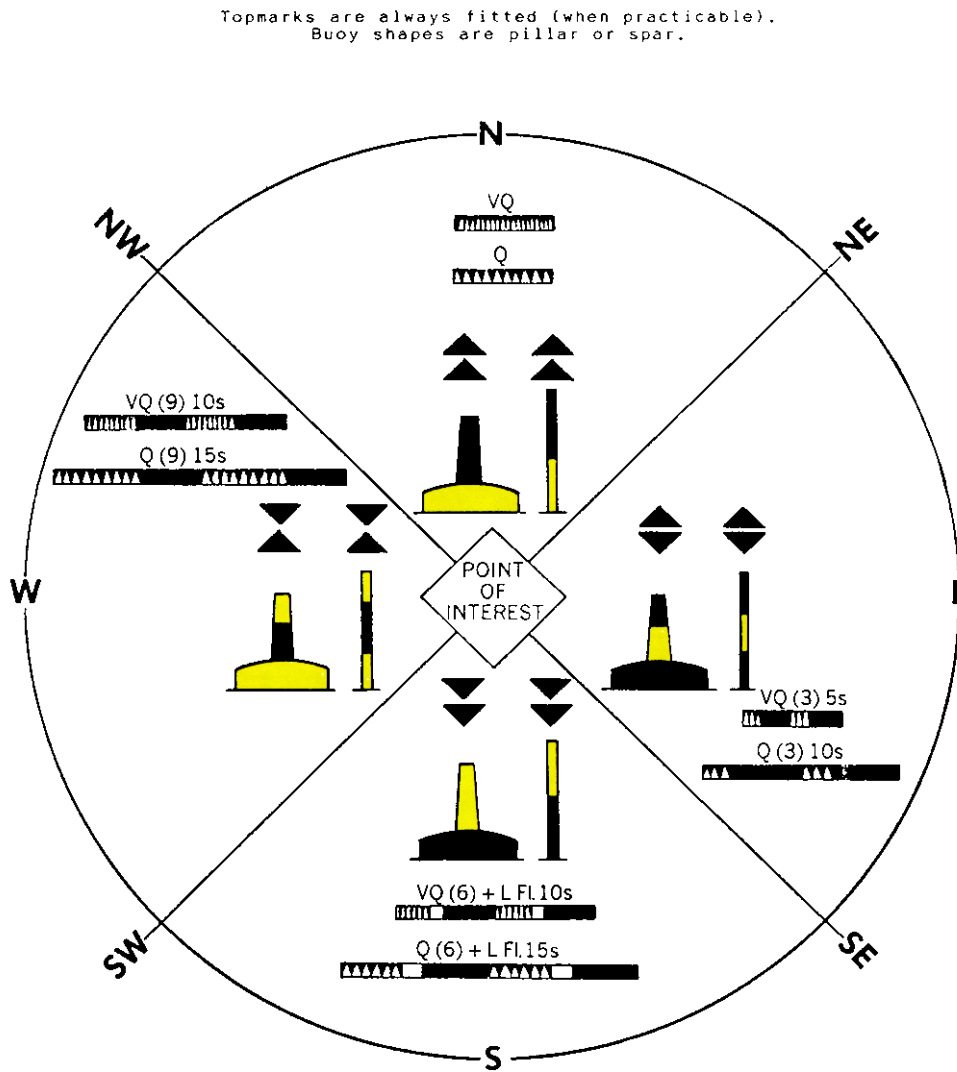

Lights, when fitted, are white , Very Quick Flashing or Quick Flashing; a South mark also has a Long Flash immediately following the quick flashes.

Figure 9-15.—IALA Maritime Buoyage System cardinal marks.

Topmarks

By day, topmarks are the most important features of cardinal marks. The arrangement of the cones must be memorized. For north, the points of the cones is up; and for south, the points of the cones is down. An aid to help you memorize the west topmark is that it resembles a wineglass. Cardinal marks carry topmarks, whenever practical, with cones as large as possible and clearly separated.

Color

Black and yellow horizontal bands are used to color cardinal marks. The position of the black band, or bands, is related to the point of the black topmarks. The black and yellow horizontal bands are used as follows:

- North—Black bands above yellow bands
- South—Black bands below yellow bands
- West—Black band with yellow bands above and below
- East—Black bands above and below yellow band

The shape of a cardinal mark is not important; but in the case of a buoy, it will be pillar or spar.

Light Characteristics

When lighted, a cardinal mark exhibits a white light. The characteristics are based on a group of quick (Q) or very quick (VQ) flashes, which distinguishes it as a cardinal mark and indicates its quadrant. The distinguishing quick or very quick flashes are as follows:

- North—Very quick flashing (VQ) or quick flashing (Q)

- East—Very quick flashing every 5 seconds (VQ (3) 5s) or quick flashing every 10 seconds (Q (3) 10s)

- South—Very quick flashes followed by a long flash every 10 seconds (VQ FL (6) + LFl 10s) or quick flashing followed by a long flash every 15 seconds (Q (6) + LFl 15s)

- West—Very quick flashing light every 10 seconds (VQ (9) 10s) or quick flashing every 15 seconds (Q (9) 15s)

As a memory aid, associate the number of flashes in each group with a clock face (3 o'clock, east; 6 o'clock, south; and 9 o'clock, west).

The long flash immediately following the group of flashes from a south cardinal mark is to ensure that its six flashes cannot be mistaken for three or nine.

Quick flashing lights flash at a rate of either 50 or 60 flashes per minute. Very quick flashing lights flash at a rate of either 100 or 120 flashes per minute. It is necessary to have a choice of quick or very quick flashing light to avoid confusion. Two north buoys that are placed near enough to each other to be mistaken is one example where the quick flashing or very quick flashing lights would be needed.

ISOLATED DANGER MARKS

An isolated danger mark (fig. 9-16) is erected on, or moored above, an isolated danger of limited extent. An isolated danger mark has navigable water all around it. The extent of the surrounding navigable water is not important. The isolated danger mark can, for example, indicate either a shoal that is well

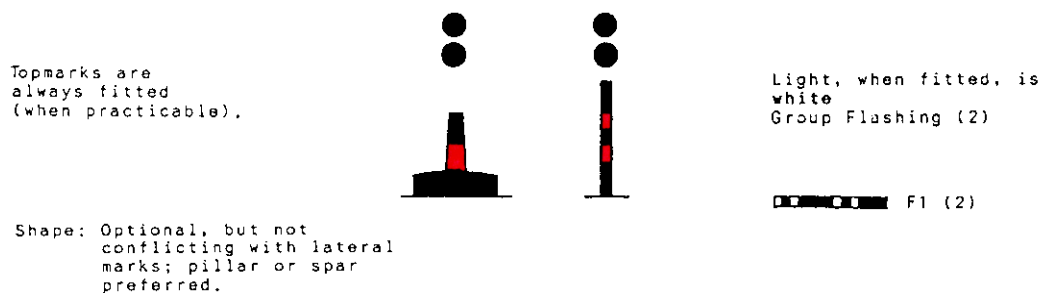

Figure 9-16.—IALA Maritime Buoyage System isolated danger marks.

offshore or an islet separated by a narrow channel from the coast.

A black double-sphere topmark is, by day, the most important feature of an isolated danger mark. Whenever practical, this topmark will be carried with the spheres as large as possible, mounted vertically, and clearly separated.

Black, with one or more red horizontal bands, is used for isolated danger marks. The shape of an isolated danger mark is not significant, but in the case of a buoy, it will be either pillar or spar.

When lighted, a white flashing light showing a group of two flashes (FL (2)) is used to denote an isolated danger mark. The association of two flashes and two spheres in the topmark may be a help in remembering these characteristics.

SAFE-WATER MARKS

A safe-water mark (fig. 9-17) is used to indicate there is navigable water all around the mark. Such a mark may be used as a centerline, midchannel, or landfall buoy.

Red and white vertical stripes are used for safe-water marks. The vertical stripes are used to distinguish them from the black-banded danger marks. Spherical, pillar, or spar buoys may be used as safe-water marks. Whenever practical, a pillar or spar buoy used as a safe-water mark will carry a single red sphere topmark.

When lighted, a safe-water mark exhibits a white light. The phase characteristics of the light will be occulting, equal intervals, one long flash every 10 seconds, or Morse A. The association of a single flash and a single sphere in the topmark may help you to remember its characteristics.

SPECIAL MARKS

A special mark (fig. 9-18) may be used to indicate to the mariner a special area or feature. The nature of the special area or feature may be found by consulting the chart, *Sailing Directions*, or *Notices to Mariners*. The use of a special mark includes the following:

- Ocean Data Acquisition System (ODAS) buoys carrying oceanographic or meteorological sensors
- Traffic separation marks

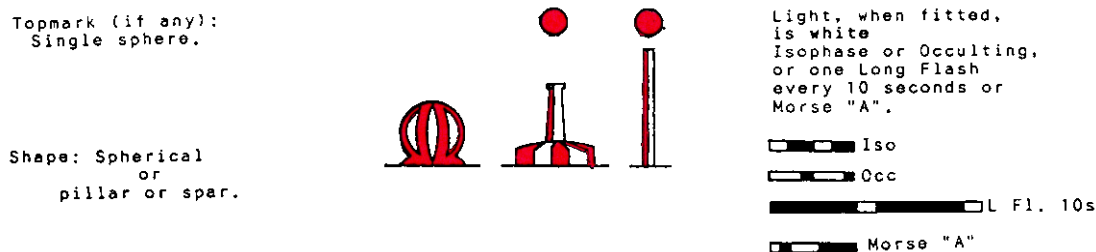

Figure 9-17.—IALA Maritime Buoyage System safe-water marks.

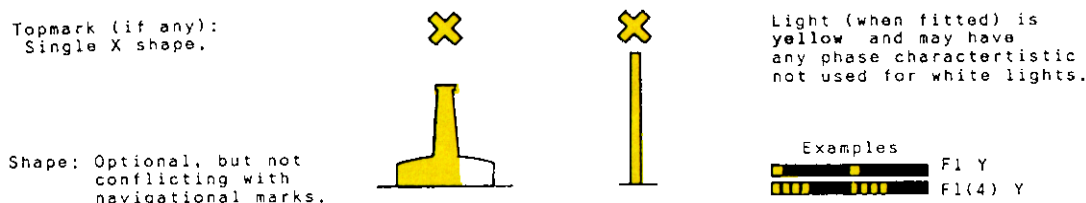

Figure 9-18.—IALA Maritime Buoyage System special marks.

- Spoil ground marks
- Military exercise zone marks
- Cable or pipeline marks, including outfall pipes
- Recreation zone marks

Another function of a special mark is to define a channel within a channel (for example, a channel for deep-draft vessels in a wide approach area where the limits of the channel for normal navigation are marked by red and green lateral buoys).

Yellow is the color used for special marks. The shape of a special mark is optional but must not conflict with a lateral or a safe-water mark.

When a topmark is carried, it takes the form of a single yellow *X*. When a light is exhibited, it is yellow. The phase light characteristics may be any other than those used for white lights of cardinal, isolated danger, and safe-water marks.

NEW DANGER

A newly discovered hazard to navigation, not yet shown on charts or included in *Sailing Directions* or sufficiently announced by *Notices to Mariners*, is called a “new danger.” New danger covers naturally occurring obstructions, such as sandbanks and rocks, or man-made dangers, such as wrecks.

A new danger is marked by one or more cardinal or lateral marks, following the IALA Maritime Buoyage System guidelines. If the danger is especially grave, it will be marked by two marks that are identical until the danger has been announced.

If a lighted mark is used for a new danger, it must be a quick flashing or very quick flashing light. If it is a cardinal mark, it must exhibit a white light; if a lateral mark is used, it must exhibit a red or green light.

AIDS IN THE INTRACOASTAL WATERWAY

The Intracoastal Waterway, called the inland waterway, is a channel in which a lightdraft vessel can navigate coastwise from the Chesapeake Bay almost to the Mexican border, remaining inside natural or artificial breakwaters for almost the entire length of the trip. The following paragraphs describe special markings for the Intracoastal Waterway proper and for those portions of connecting or intersecting waterways that must be crossed or followed in navigating it.

Every buoy, daymark, or light structure along the Intracoastal Waterway has part of its surface painted yellow, the distinctive coloring adopted for this waterway. Lighted buoys have a band or border of yellow somewhere.

Red buoys and daymarks are to the right, and green to the left, as you proceed from the Chesapeake Bay toward Mexico. As in other channels, red buoys have even numbers; green buoys, odd numbers. Because the numbers would increase excessively in such a long line of buoys, they are numbered in groups that usually contain no more than 200 buoys. At certain natural dividing points, numbering begins again at 1.

Lights on buoys in the Intracoastal Waterway follow the standard system of red or white lights on red buoys, and green lights on green buoys. Lights on lighted aids besides buoys also agree with the standard rules for lights on aids to navigation.

RANGES

Two daybeacons located some distance apart on a specific true bearing constitute a daybeacon range. Two lights similarly located comprise a lighted range. When a ship reaches a position where the two lights or beacons are seen exactly in line, it is on the range. Ranges are especially valuable for guiding ships along the approaches to or through narrow channels.

Lights on ranges may show any of the four standard colors, and they may be fixed, flashing, or occulting, the principal requirement being that they stand out distinctly from their surrounding. Range light structures are usually fitted with colored daymarks for daytime use. Range lights appear to lose brilliance rapidly as a ship veers from the range line of bearing.

Ranges should only be used after a careful examination of the charts; it is particularly important to determine how far the range line can be followed safely. This information is available on the chart.

FOG SIGNALS

Most lighthouses, light towers, and large navigational buoys are equipped with fog-signaling apparatus, generally sounded automatically by mechanical means. For purposes of identification, each station has its own assigned number of blasts, recurring at specified intervals. A definite time is required for each station to sound its entire series of blasts, providing additional identification.

The different types of apparatus used will produce corresponding variances of pitch and tone, thus giving your ear a chance to compare the sound of a station with its description in *Light Lists*. The types of apparatus and the sounds produced are as follows:

- **Diaphones** create sound by means of slotted reciprocating pistons actuated by compressed air. The resulting sound consists of two tones of different pitch, the first part of the blast being high-pitched, the remainder low.

- **Diaphragm horns** are sounded by a disk diaphragm that is vibrated by compressed air, steam, or electricity. Duplex or triplex horn units of differing pitch give a time signal.

- **Reed horns** emit sound through a steel reed that is vibrated by compressed air.

- **Sirens** produce sound by either a disk or a cupshaped rotor. They are actuated by compressed air, steam, or electricity.

- **Whistles** make sound by compressed air or steam admitted through a slot into a cylindrical chamber.

- **Bells** are sounded by gas or electricity, or possibly by a hand-hammer; on buoys, wave action is used.

RULES OF THE ROAD

LEARNING OBJECTIVES: Identify and explain the differences between International and Inland Rules of the Road.

As a Signalman, you must become acquainted with basic Rules of the Road. Rules of the Road are published by the Coast Guard in a booklet entitled *Navigation Rules, International—Inland*, COMDTINST M16672.2B. You should use it to become more familiar with the different Rules of the Road.

International Rules are specific rules for all vessels upon the high seas and on connecting waters navigable by seagoing vessels. Inland Rules apply to all vessels upon the inland waters of the United States and to vessels of the United States on the Canadian waters of the Great Lakes to the extent that there is no conflict with Canadian law.

International Rules were formalized at the Convention on the International Regulations for Preventing Collisions at Sea, 1972. These rules are commonly called 72 COLREGS.

The Inland Navigational Rules discussed in this chapter replace the old Inland Rules, the Western Rivers Rules, the Great Lakes Rules, their respective pilot rules, and parts of the Motorboat Act of 1940. The new rules went into effect on all United States inland waters except the Great Lakes on 24 December 1981. The Inland Rules became effective on the Great Lakes on 1 March 1983.

The International/Inland Rules contain the 38 rules that comprise the main body of the rules, and five annexes, which are regulations. The International/Inland Rules are broken down into five parts as follows:

- Part A—General
- Part B—Steering and Sailing Rules
- Part C—Light and Shapes
- Part D—Sound and Light Signals
- Part E—Exemptions

STEERING AND SAILING RULES

You must understand the Steering and Sailing Rules and be able to apply them to various traffic situations. Although all Rules of the Roads are important, the steering and sailing are the most essential to know to avoid collision. The risk of collision can be considered to exist if the bearing of an approaching vessel does not change within reason.

In International Rules, whistle signals are signals of actions; and in Inland Rules, they are signals of intention. The following is a list of International and Inland whistle signals.

SIGNALS	INTERNATIONAL RULES	INLAND RULES
One short blast	I am altering my course to starboard	I intend to leave you on my port side
Two short blasts	I am altering my course to port	I intend to leave you on my starboard side
Three short blasts	I am operating astern propulsion	(Same as International)
Five or more short blasts	Danger signal	(Same as International)
One prolonged blast	Will be sounded by a vessel when nearing a blind bend around which vision is obscured	(Same as International)

Head-on Situation

When two ships meet head-on or nearly so (fig. 9-19), each ship must change course to starboard and pass port-to-port. In international waters, a whistle signal is sounded only when a course change is actually made. If the meeting ships are already far enough off from each other to pass clear on their present courses, no signal is needed. Rule 14 of the *International Rules of the Road* applies here.

Crossing Situation

When two power-driven vessels are crossing so as to involve the risk of collision (fig. 9-20), the vessel

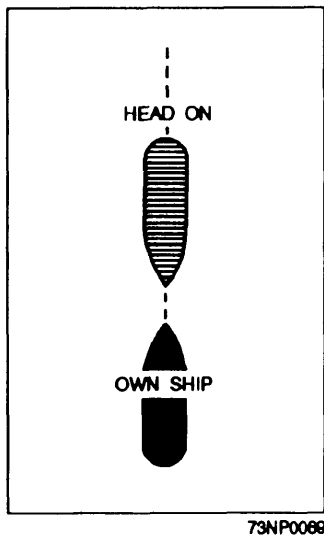
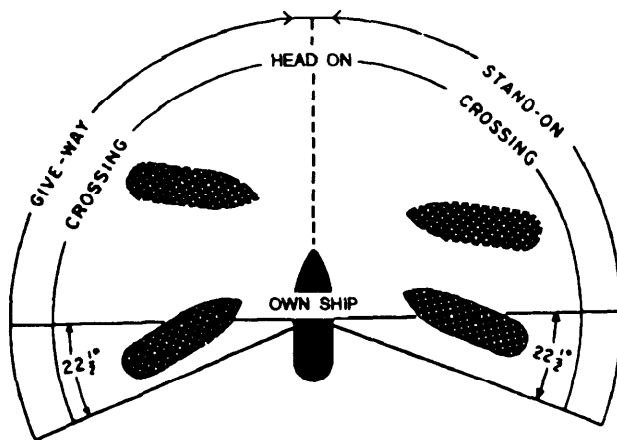

Figure 9-19.—Meeting (head-on) situation.



NOTE:
VESSELS TO BE CONSIDERED IN
RELATION TO OWN SHIP ONLY.
COLLISION COURSE ASSUMED.

73NP0070

Figure 9-20.—Crossing situation.

having the other to starboard must keep out of the way and will avoid, if circumstance permits, crossing ahead of the other vessel. Rule 15 applies here.

Overtaking Situation

Any vessel overtaking another must keep clear of the overtaken vessel. An overtaking vessel is one that is approaching another vessel from any direction more than 22.5° abaft its beam (fig. 9-21). When in doubt, assume you are overtaking and act accordingly. Rule 13 applies here.

Sailing Vessel

A sailing vessel has the right-of-way over power-driven vessels except when the power-driven vessel is engaged in fishing, is not under command or is restricted in her ability to maneuver. Rule 12 applies here.

Stand-on/Give-away Situation

The stand-on vessel is the vessel that stays on course and speed. The give-away vessel is the vessel that keeps out of the way of the other vessel. In a head-on situation, both vessels are the give-away vessel. Each vessel shall alter her course to starboard, so that they will pass on the port side of each other. Rules 16 and 17 apply here.

Take a little time and learn these rules. They will be useful to you.

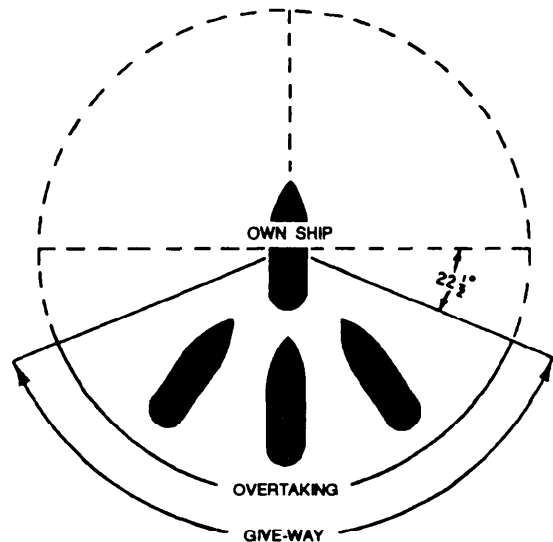

NOTE:
VESSELS TO BE CONSIDERED IN
RELATION TO OWN SHIP ONLY.
COLLISION COURSE ASSUMED.

73NP0071

Figure 9-21.—Overtaking situation.

LIGHTS AND SHAPES

Rules for lights must be complied with in all weather, from sunset to sunrise, as specified by both International and Inland Rules of the Road.

Navigational lights and dayshapes of another vessel convey information such as clues to the type and size of vessel, its heading in relation to your vessel, type of operation in which it may be engaged, and other data that is helpful in determining right of way and preventing a collision.

Various navigational light and dayshape displays prescribed by the rules are discussed in the following topics.

Running Lights

When the rules refer to a power-driven vessel, they mean one propelled by any kind of machinery, as distinct from a sailing ship under sail. A vessel under way means a ship not at anchor, not made fast to the shore, or not aground. The ship does not actually have to be making headway.

Both rules state that the rules for lights must be complied with in all weather from sunset to sunrise, and should also be exhibited from sunrise to sunset in restricted visibility. These lights may be exhibited in all other circumstances when it is deemed necessary. Ships usually are darkened during wartime conditions; but even then, lights are kept ready for immediate display.

MASTHEAD LIGHT.—You are aware that a power-driven vessel underway carries a white light (masthead light) placed over the fore and aft centerline of the vessel, showing an unbroken light over an arc of the horizon of 225° and so fixed as to show the light from right ahead to 22.5° abaft the beam on either side of the vessel. The light at the fore masthead, or some other elevated point forward, is between 20 and 40 feet above the deck. This light must be visible from 2 to 6 miles, depending on the length of the vessel. You know, too, that under both rules, a power-driven vessel over 50 meters in length shows another white light aft, at least 15 feet higher than the fore masthead light. The horizontal distance between these lights should not be less than one-half the length of the vessel but need not be more than 100 meters. The after light, called the aft masthead light, is mandatory under both rules except for vessels less than 50 meters in length. A power-driven vessel less than 12 meters may show an all-round white light in lieu of the masthead light.

SIDELIGHTS.—Sidelights mean a green light on the starboard side and a red light on the port side, each showing an unbroken light over an arc of the horizon of 112.5° and so fixed as to show the light from right ahead to 22.5° abaft the beam on its respective side. In a vessel of less than 20 meters, the sidelights may be combined in one lantern carried on the fore and aft centerline of the vessel.

Side lights must be visible from 1 to 3 miles, depending on the size of the vessel. A sailing vessel or a ship being towed displays side lights and a stern light only—never masthead lights. A vessel under oars or a sailing vessel of less than 7 meters in length need carry only a lantern showing a white light, which it must exhibit in time to prevent collision. If practicable, a sailing vessel of less than 7 meters must exhibit the lights prescribed for a sailing vessel under way.

STERNLIGHT.—A white light placed as nearly as practicable at the stern, showing an unbroken light over an arc of the horizon of 135° and so fixed as to show the light 67.5° from right aft on each side of the vessel.

TOWING LIGHT.—The towing light is a yellow light having the same characteristics as a sternlight.

Lights, Pilot Vessels

An OOD or conning officer often is most anxious to sight the pilot boat and signal it alongside without being forced to lie to when conditions may be setting the ship toward a lee shore. Signalmen should recognize a pilot vessel the instant it is sighted.

Pilot vessels, when engaged on their stations on pilotage duty, should not show the lights required for other vessels. A pilot vessel should exhibit at or near the masthead two all-round lights in a vertical line, the upper being white and the lower red, and when under way (fig. 9-22), in addition, sidelights and a sternlight. When at anchor, in addition to those lights previously described, the pilot vessel should show the anchor light, lights, or shape prescribed for anchored vessels. The daytime display for a pilot vessel is the display of the HOTEL flag.

Pilot vessels, when not engaged on pilotage duty, should exhibit the lights or shapes prescribed for similar vessels of their length.

Vessel at Anchor

A vessel at anchor (fig. 9-23) should show, where it can best be seen, an all-round white light or one ball in the forepart of the vessel, and, at or near the stern,

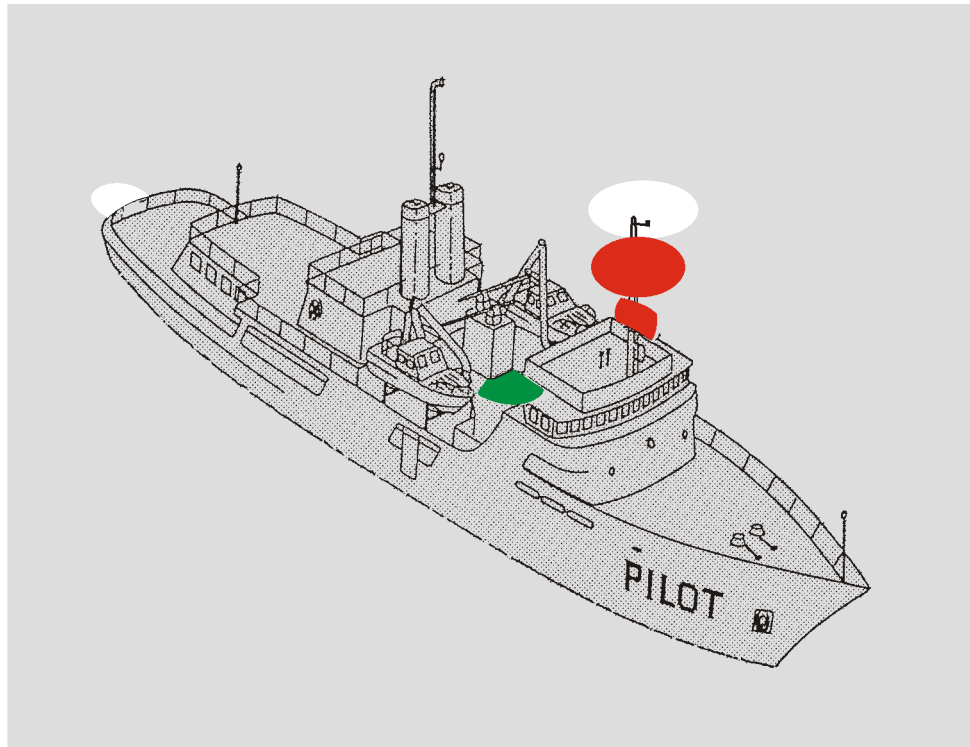

SMf0922

Figure 9-22.—Pilot vessel, under way.

an all-round white light at a level lower than the light in the forepart of the vessel. Rule 30 applies here.

NOTE

A vessel less than 50 meters may substitute one white light where best seen. A vessel 100 meters or greater is required to illuminate its decks.

Towing Vessels

There are various light signals for towing (fig. 9-24). We will discuss a few in the following paragraphs.

LESS THAN 50 METERS.—A power-driven vessel less than 50 meters that is towing astern and the length of the tow does not exceed 200 meters is required to display two masthead lights, sidelights, and a yellow-over-white sternlight.

GREATER THAN 50 METERS.—A power-driven vessel greater than 50 meters that is towing astern and the length of tow does not exceed 200 meters is required to display two masthead lights, an after masthead light, sidelights, and a yellow-over-white sternlight.

LESS THAN 50 METERS, TOW EXCEEDS 200 METERS.—A vessel less than 50 meters that is towing astern with the length of tow exceeding 200 meters must display three masthead lights, sidelights, and a yellow-over-white sternlight. The dayshape display will be a DIAMOND.

TOWING, RESTRICTED MOVEMENT.—A vessel unable to deviate from its course and the length of tow does not exceed 200 meters is to display two masthead lights, sidelights, a yellow-over-white sternlight, and the light signal RED-WHITE-RED. The dayshape display will be BALL-DIAMOND-BALL and a DIAMOND.

When the length of tow exceeds 200 meters, the vessel is to display three masthead lights, sidelights, a yellow-over-white sternlight, and the light signal RED-WHITE-RED. The dayshape display will be the same as above. Rule 24 applies here.

Not-Under-Command Lights

A vessel not under command (fig. 9-25) should display the following lights: RED-RED displayed vertically, sidelights, and a sternlight. The sidelights and sternlight are only displayed when making way through the water. The dayshape signal for a vessel not under command is two black balls displayed vertically. Rule 27 applies here.

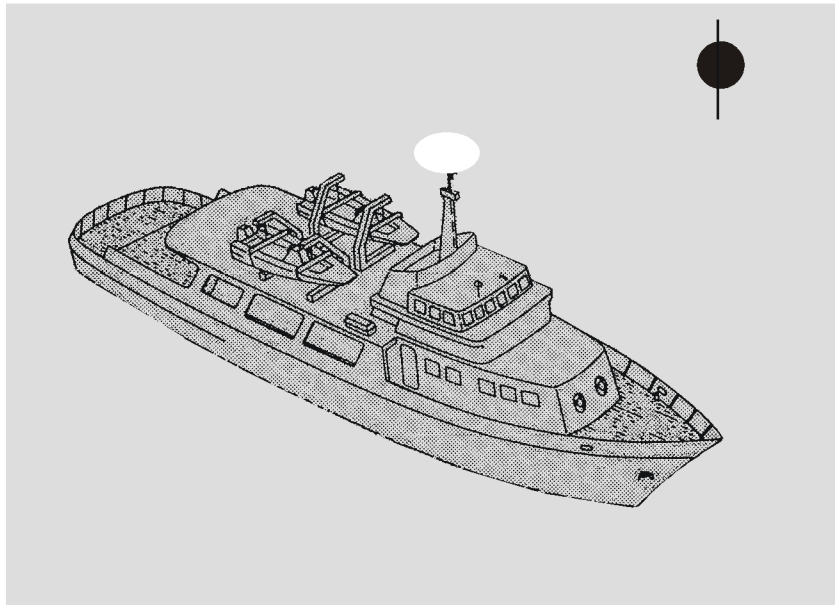

(A)

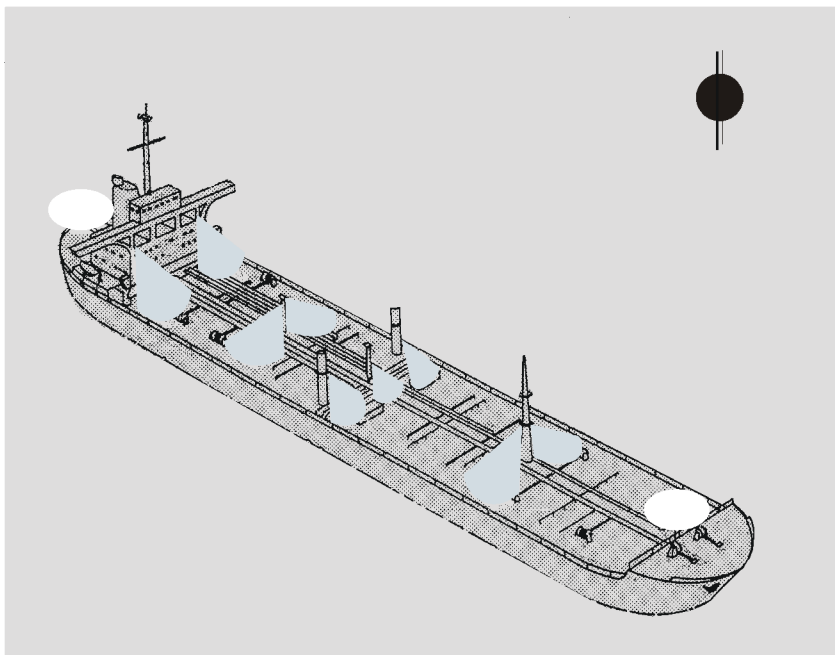

(B)

Smf0923

Figure 9-23.—Vessels at anchor: (A) vessel less than 50 meters; (B) vessel greater than 50 meters.

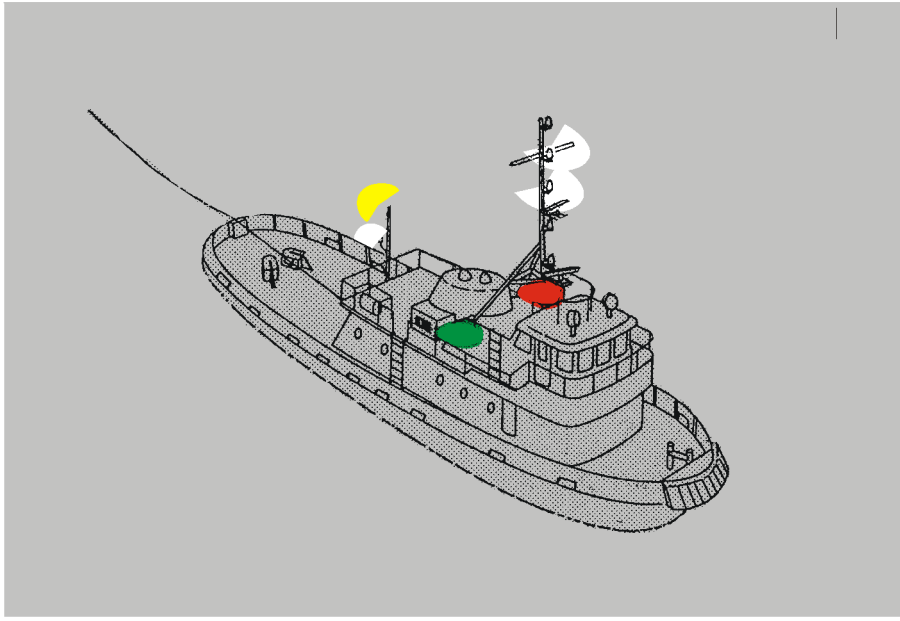

(A)

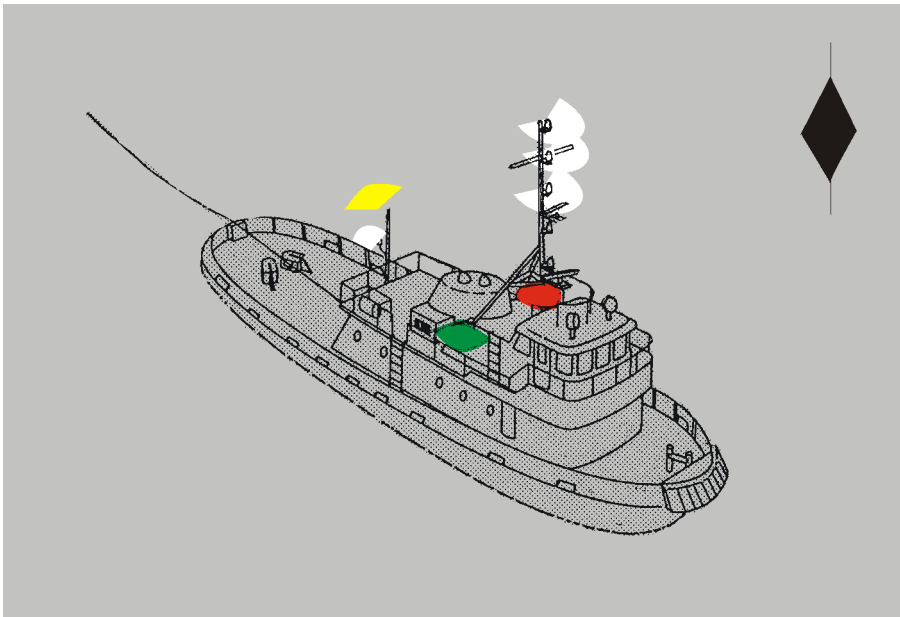

(B)

SMf0924

Figure 9-24.—Towing vessels less than 50 meters in length: (A) length of tow is 200 meters or less; (B) length of tow exceeds 200 meters.

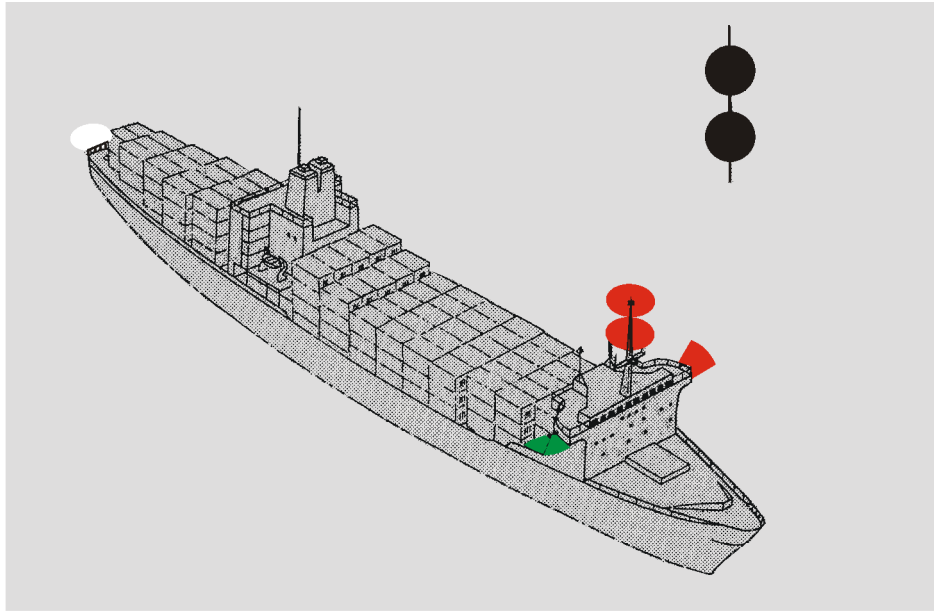

(A)

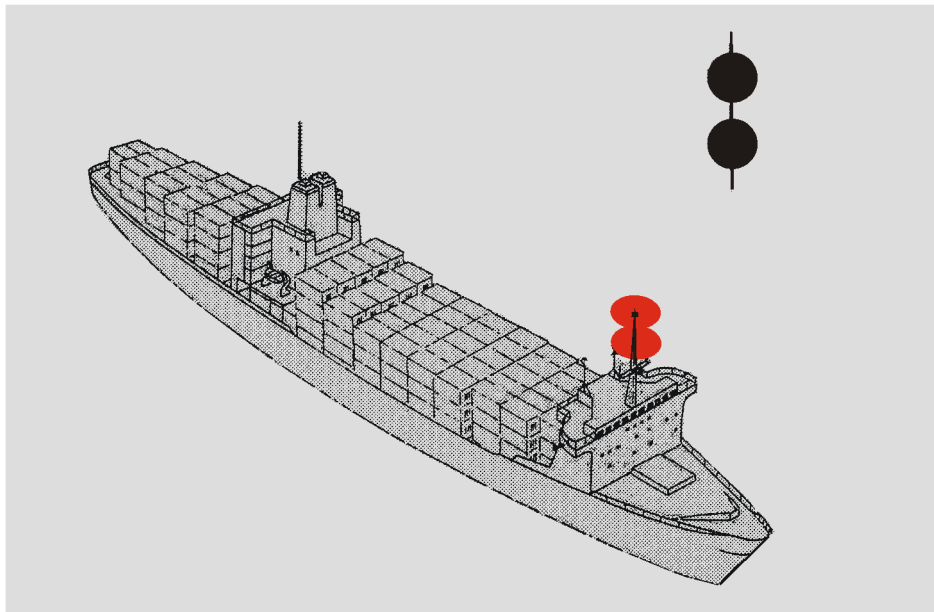

(B)

Smf0925

Figure 9-25.—Vessels not under command: (A) making way; (B) not making way.

Dredging/Underwater Operation

When a vessel is dredging or is involved in underwater operations (fig. 9-26), the following light signals are required: RED-WHITE-RED displayed vertically, RED-RED on the obstructed side, GREEN-GREEN on the clear side, a masthead light,

a sternlight, and sidelights. The masthead, sternlight, and sidelights are only used when making way. The dayshape signal is BALL-DIAMOND-BALL displayed vertically, two black balls vertically displayed on the obstructed side, and two black diamonds displayed vertically on the clear side. Rule 27 applies here.

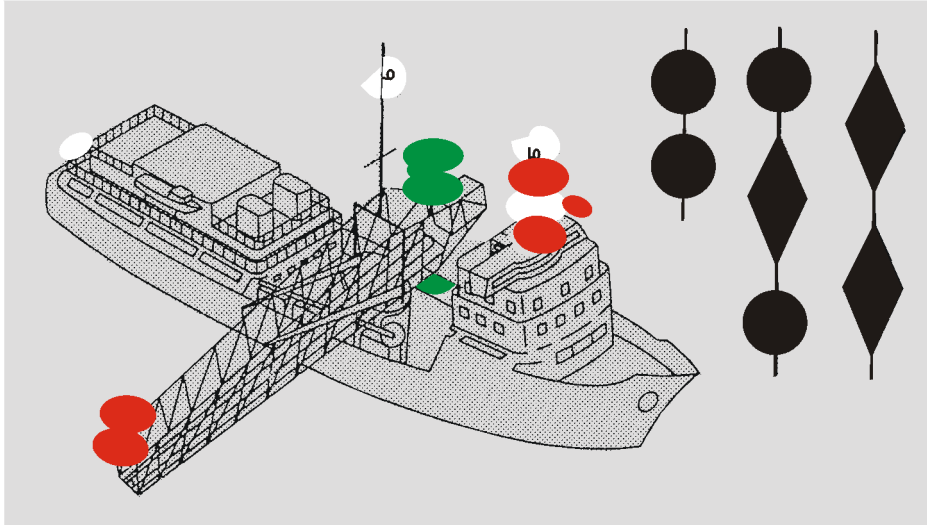

(A)

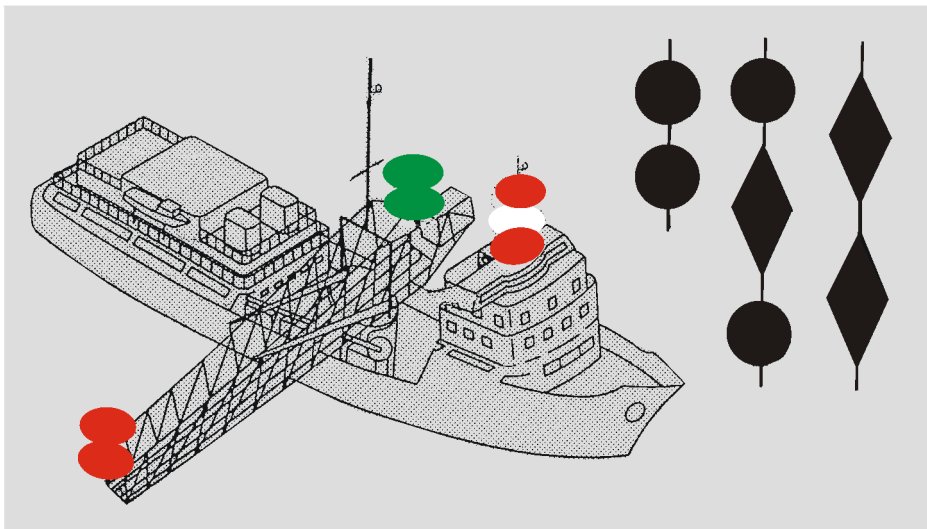

(B)

SMf0926

Figure 9-26.—Vessels engaged in dredging or underwater operations: (A) making way; (B) not making way.

Vessel Aground

The light display for a vessel aground (fig. 9-27) is RED-RED displayed vertically and the normal anchor lights for a vessel of her length. The dayshape display is three black balls displayed vertically. Rule 30 applies here.

Pushing Ahead or Alongside

The International and Inland Rules differ when it comes to pushing (fig. 9-28). The international display is two masthead towing lights, sidelights, and a sternlight. The inland display is two masthead lights, sidelights, and a yellow-over-yellow sternlight. Rule 24 applies here.

NOTE

When the pushing vessel and the vessel being pushed are connected into a composite unit, they are regarded as a power-driven vessel and must exhibit the lights for that class of vessel.

Draft

A vessel constrained by draft (fig. 9-29) is required to display the following lights: normal light for a power-driven vessel and three red lights displayed vertically. The required dayshape is a cylinder. Draft display is for International use only. Rule 28 applies here.

Conclusion

As you can see, there are numerous lights and dayshapes to be displayed. For more detailed information, see *Navigation Rules, International—Inland*, COMDTINST M16672.2B.

NOTE

When you are using lights and dayshapes, remember that they should always be displayed where best seen.

SOUND SIGNALS IN RESTRICTED VISIBILITY

Restricted visibility is defined as anything that reduces visibility below the range that a vessel would normally be visible. It can be caused by rain, fog, smoke, hail, snow, or any other condition that reduces visibility.

Rules to remember during restricted visibility are the following:

- The vessel must proceed at SAFE speed. Safe speed is determined by factors such as state of visibility; the maneuverability of the vessel; the state of the wind, sea, and current; the proximity of navigation hazards; draft in relation to the available depth of water; the traffic density, including the concentration of fishing vessels; and the characteristics and capabilities of radar, if installed.

- Power-driven vessels must have their engines ready for immediate maneuver.

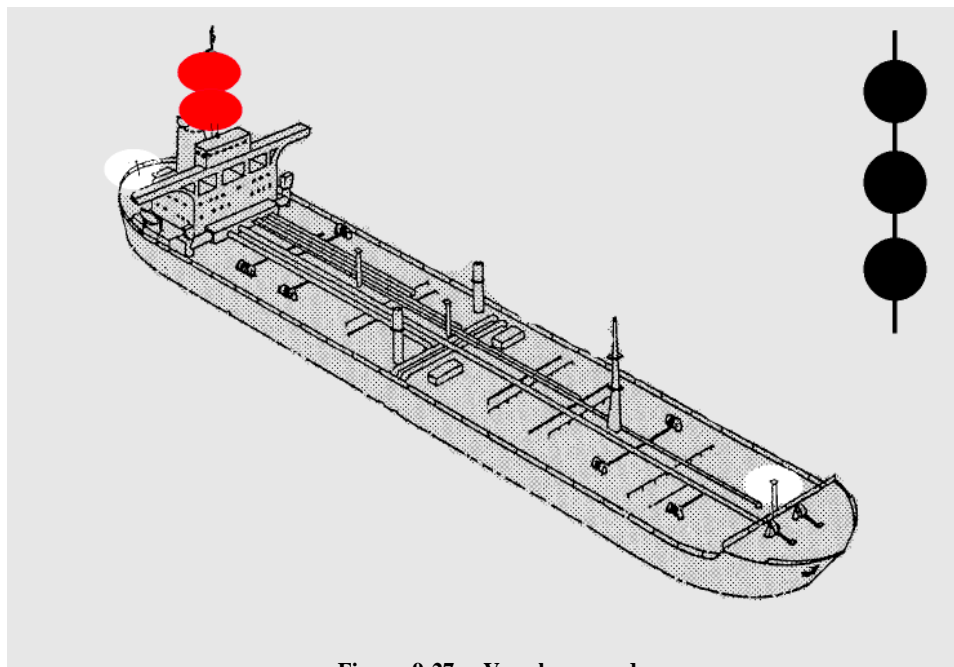
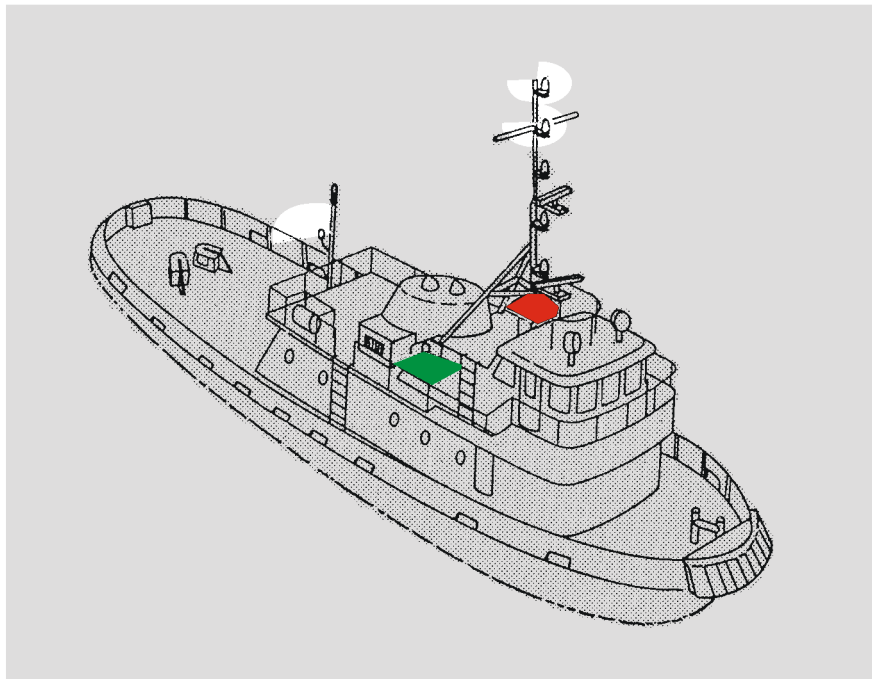
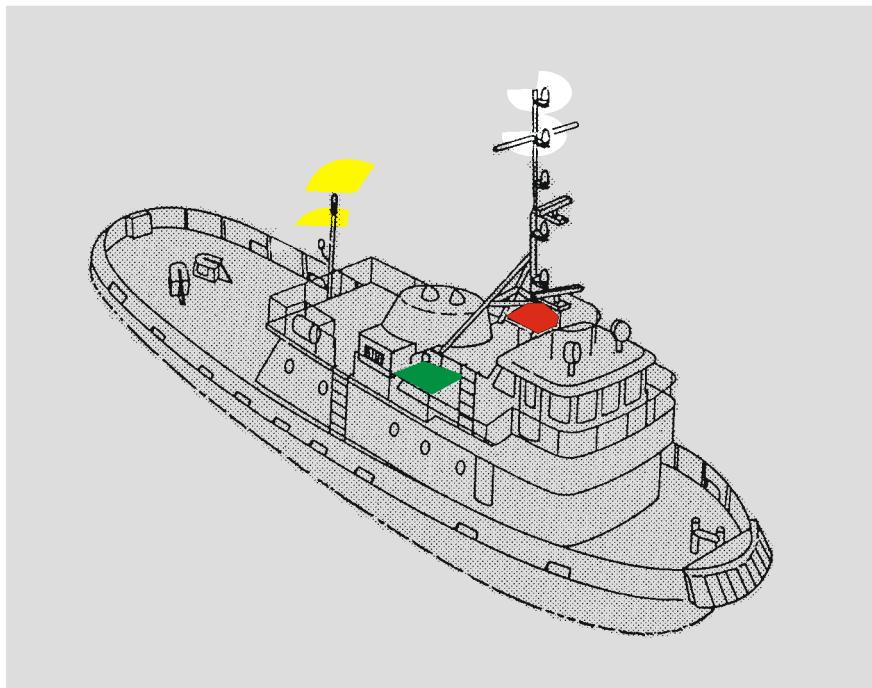

Figure 9-27.—Vessel aground.

SMI0927



(A)



(B)

SMf0928

Figure 9-28.—Pushing ahead or towing alongside: (A) International and (B) Inland.

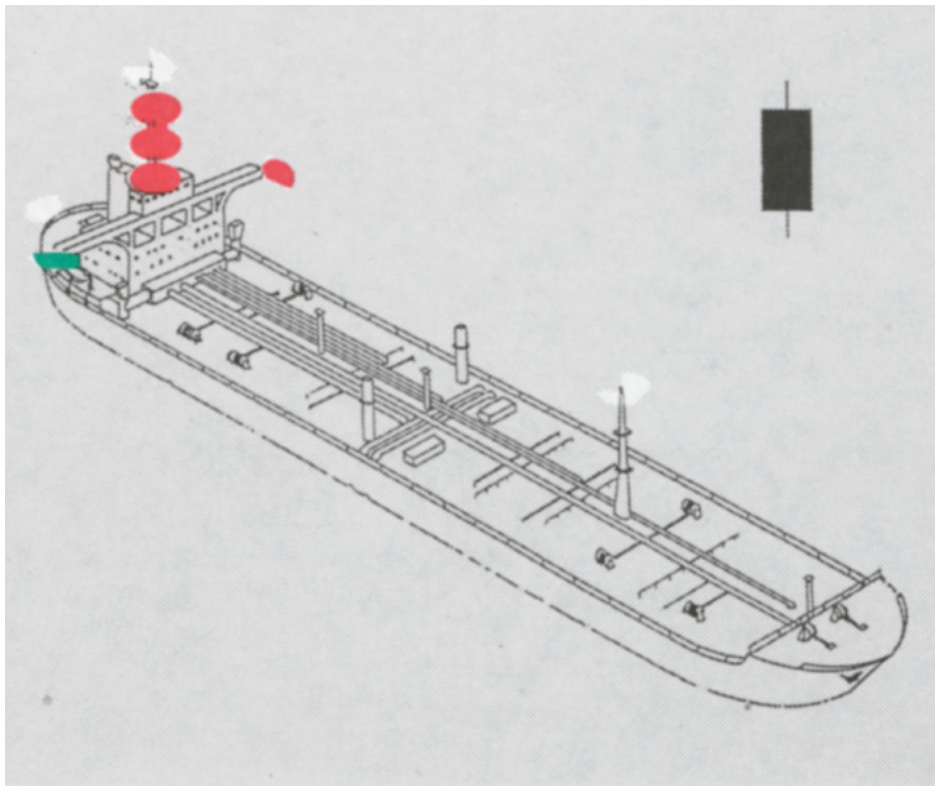

Figure 9-29.—Vessel constrained by her draft.

- Navigation lights must be exhibited from sunrise to sunset.

- Except when it has been determined that a risk of collision does not exist, every vessel that hears apparently forward of the beam the fog signal of another vessel must reduce her speed to the minimum that she can be kept on course; take all way off if necessary; or navigate with extreme caution until the risk of collision is over.

Lookout

In restricted visibility, lookouts are placed as far forward and as low to the water as possible. There must be two at each station, one to serve as the lookout and the other as the phone talker. They report everything they see or hear.

Give-way Vessels

All vessels are give-way vessels in restricted visibility. They are required to maneuver to avoid each other and to avoid turning towards any fog signals heard. Only the required fog signals will be sounded unless vessels sight each other, in which case the

normal steering and sailing whistle signals will be sounded.

Equipment

Each power-driven vessel must have a whistle, a bell mounted in the forward part of the vessel, and for a vessel 100 meters or more in length, a gong in the after part of the vessel. Vessels less than 12 meters are not required to have the whistle, bell, and gong, but they must have the means to make an efficient signal.

Types of Sound Signals

A prolonged blast is one of from 4 to 6 seconds in duration; a short blast is about 1 second in duration. As can be seen in figure 9-30, fog signals are sounded at 2-minute intervals unless otherwise noted.

A power-driven vessel making way through the water in a fog or thick weather of any kind is required by the International and Inland Rules to sound a prolonged blast at intervals of not more than 2 minutes. Under both sets of rules, a power-driven vessel under way but stopped, and having no way on sounds two prolonged blasts, with about 2 seconds between them, at intervals of not more than 2 minutes.

INTERNATIONAL		INLAND	
—	MAKING WAY	—	MAKING WAY
— —	UNDERWAY BUT STOPPED AND MAKING NO WAY	— —	UNDERWAY BUT STOPPED AND MAKING NO WAY
— . .	VESSEL NOT UNDER COMMAND, VESSEL RESTRICTED IN HER ABILITY TO MANEUVER, VESSEL CONSTRAINED BY DRAFT, SAILING VESSEL, VESSEL ENGAGED IN FISHING, VESSEL ENGAGED IN TOWING OR PUSHING	— . .	VESSEL NOT UNDER COMMAND, VESSEL RESTRICTED IN HER ABILITY TO MANEUVER UNDERWAY OR AT ANCHOR, SAILING VESSEL, VESSEL ENGAGED IN FISHING UNDERWAY OR AT ANCHOR, VESSEL ENGAGED IN TOWING OR PUSHING ANOTHER VESSEL
— . . .	VESSEL BEING TOWED OR LAST VESSEL OF TOW	— . . .	VESSEL BEING TOWED OR LAST VESSEL OF TOW
RAPID RINGING OF BELL FOR 5 SEC. EV. MIN.	ANCHORED	RAPID RINGING OF BELL FOR 5 SEC. EV. MIN.	ANCHORED
. — .	ANCHORED OVER 100 METERS	. — .	ANCHORED OVER 100 METERS
RAPID RINGING OF BELL FOR 5 SEC. FOLLOWED BY RAPID RINGING OF GONG EVERY MINUTE	3 SEPARATE & AGROUND DISTINCT STROKES ON BELL IMMEDIATELY BEFORE & AFTER RAPID RINGING OF BELL	RAPID RINGING OF BELL FOR 5 SEC. FOLLOWED BY RAPID RINGING OF GONG EVERY MINUTE	3 SEPARATE & AGROUND DISTINCT STROKES ON BELL IMMEDIATELY BEFORE & AFTER RAPID RINGING OF BELL
. . .	PILOT VESSEL ENGAGED ON PILOTAGE DUTY	. . .	PILOT VESSEL ENGAGED ON PILOTAGE DUTY
NOTE: SIGNAL INTERVALS ARE 2 MINUTES UNLESS OTHERWISE NOTED.			

Figure 9-30.—Sound signals in restricted visibility.

A vessel not under command; a vessel restricted in her ability to maneuver, whether under way or anchored; a sailing vessel; a vessel engaged in fishing, whether under way or anchored; and a vessel engaged in towing or pushing another vessel will

sound one prolonged blast, followed by two short blasts at 2-minute intervals.

A vessel at anchor must, at intervals of not more than a minute, ring the bell rapidly for about 5

seconds. On a vessel of 100 meters or more, the bell must be sounded in the fore part of the ship, followed immediately by the rapid ringing of the gong for 5 seconds in the after part of the ship. A vessel at anchor may, in addition, sound three blasts in succession—one short, one prolonged, and one short—to give warning of its position and of the possibility of collision with an approaching vessel.

SUMMARY

In this chapter, you learned about some of your navigational duties. You learned about the compass,

bearing and azimuth circle, and telescopic alidades. You learn about navigational charts and publications and the different aids to navigation. You learned about the Rules of the Road, including steering, sailing, lights, shapes, and sound signals for restricted visibility. This chapter is just an introduction to your navigational duties, so it is up to you to learn as much as you can when you get the chance. While steaming independently, ask your supervisor if you may go down to the bridge to stand watch with the Quartermaster of the watch. On some ships today, Signalmen stand Quartermaster watches.

CHAPTER 10

HONORS AND CEREMONIES

From the days when the United States first came into being as an independent nation, tradition has played an important role in the ceremonial functions of our Navy. At first, most of the honors and ceremonies rendered by our Navy were carried over from the British Navy. Before many years, however, the U.S. Navy began changing them to conform to its own concepts. The U.S. Navy now has a very rigid set of rules that covers all phases of ceremonial functions.

Of all the ratings aboard ship, Signalman is most directly concerned with rules for rendering honors and ceremonies. When the occasions for rendering them arise, there is often insufficient time to search through the regulations for needed information. That is why Signalmen must know, in advance, what, when, how, where, and by whom honors are rendered. This chapter attempts to answer some of those requirements. Additional information is contained in *Flags, Pennants and Customs*, NTP 13, and *U.S. Navy Regulations*, chapter 12.

FLAG DISPLAYS

LEARNING OBJECTIVE: Explain the procedures for the display of the national ensign, union jack, U.S. Navy flag, and United Nations flag.

A national flag is the flag flown to represent a national government. The ensign is a flag designated by a country to be flown by its men-of-war. In the United States, the designs of the two are identical. As used in this section, national flag and ensign are synonymous. Aboard ship, however, the national flag always is referred to as the ensign. The union jack is the rectangular blue part of the United States flag containing the stars.

NATIONAL FLAG

There are numerous rules for displaying of the national flag, some of which are discussed in the following paragraphs. See NTP 13 for more instructions on the display of the national flag.

Group

The national flag must be at the center and at the highest point of the group when a number of flags or pennants of states, localities, or societies are grouped and displayed from staffs.

Crossed Staff

The national flag, when displayed with another flag against a wall from crossed staffs must be on the right—the flag's own right—and its staff must be in front of the staff of the other flag.

Church Services

No other flag or pennant is to be placed above or, if on the same level, to the right of the national flag. The only exception to this rule is during church services conducted by naval chaplains at sea for personnel of the Navy. Then the church or Jewish worship pennant may be flown above the national flag. The term *at sea* is interpreted to mean on board a ship of the U.S. Navy.

Covering a Casket

When the national flag is used to cover a casket, it must be so placed that the union is at the head over the left shoulder. The flag must not be lowered into the grave or allowed to touch the ground.

Behind a Speaker

When used on a speaker's platform, the national flag, if displayed flat, is displayed above and behind the speaker.

Half-Mast

The national flag, if flown at half-mast, must first be hoisted to the peak. On the last note of the national anthem or "To the Colors," it is then lowered smartly to that position. Before the flag is lowered from the half-mast position, it is hoisted smartly to the peak on the first note of the music and then ceremoniously lowered.

NATIONAL ENSIGN

The following rules govern the display of the national ensign in port and under way.

In Port

When not under way, commissioned ships display the ensign from the flagstaff at the stern and the union jack from the jackstaff at the bow from 0800 to sunset. In the case of a mastless ship, the ensign will be displayed from the loftiest hoist on board. After entering a foreign port during darkness, a Navy ship briefly displays the ensign from the gaff at first light to establish nationality. Other ships of war present customarily display their ensigns in return.

According to SECNAVINST 10520.4, the oldest ship in the Navy, as identified by the Chief of Naval Operations, is to display the first Navy jack, in lieu of the union jack, at the jackstaff.

Under Way

When flown under way during peacetime, the ensign normally is displayed during daylight from the gaff (or triatic stay in the case of those ships with mast-mounted booms and stays, which would interfere with the hoisting, lowering, or flying of the national ensign) under the following situations unless otherwise directed by the senior officer present:

- Getting under way or mooring/anchoring

- Falling in with other ships
- Cruising near land
- When engaged in battle

When cruising under wartime conditions, it is customary to fly the national ensign continuously at sea, since battle action may be regarded as always imminent.

The union jack is not flown under way except in the case to denote a general court-martial or court of inquiry is in session. In that case, it is flown from a signal yardarm.

Size of Ensign/Jack for Shipboard Use

Table 10-1 shows the appropriate size of the ensign and jack to be used aboard your ship. Remember that the union jack must be the same size as the union portion of the ensign being flown from the flagstaff.

Shore Display of the National Ensign

The national ensign is displayed from 0800 until sunset at all U.S. naval activity headquarters. The following are additional rules that apply to the display of the national ensign:

- No other flag or pennant will be displayed above or, if on the same level, to the right of the ensign.

Table 10-1.—Sizes of Ensigns and Jacks for Shipboard Use

LENGTH			HOLIDAY			DAILY		
SHIP	FLAG STAFF	JACK STAFF	S I Z E	ENSIGN DIMENSION	JACK DIMENSION	S I Z E	ENSIGN DIMENSION	JACK DIMENSION
Less 100'	10'	Jackstaffs with anchor lights mounted thereon shall be of sufficient height so as to conform to Rules of the Road	8	3'6" × 6' 7 3/4"	1' 10 9/16" × 2' 7 5/16"	10	2' 4 7/16" × 4'6"	(See Note 1)
100'-150'	12'		8	3'6" × 6' 7 3/4"	1' 10 9/16" × 2' 7 5/16"	10	2' 4 7/16" × 4'6"	(See Note 1)
151'-200'	15'		7	5'0" × 9' 6"	2' 8 1/4" × 3' 9 5/8"	8	3'6" × 6' 7 3/4"	1' 10 9/16" × 2' 7 15/16"
201'-450'	17'		7	5'0" × 9'6"	2' 8 1/4" × 3' 9 5/8"	8	3'6" × 6' 7 3/4"	1' 10 9/16" 2' 7 15/16"
451'-UP	22'		5	8' 11 3/8" × 17' 0"	4' 9 13/16" × 6' 9 5/8"	7	5'0" × 9'6"	2' 8 1/4" × 3' 9 5/8"

- When displayed with foreign ensigns, the U.S. ensign must be displayed to the extreme right and on the same level. International usage forbids displaying the flag of one nation over that of another nation in time of peace. The national ensign of other nations is displayed to the left of the U.S. ensign, beginning in alphabetical order. The only exception to this rule is when the U.S. naval activity is in a foreign country, in which case that country's flag will be to the immediate left of the U.S. ensign without regard to alphabetical listing.

- In a semicircular grouping, all flags other than the U.S. ensign are displayed in alphabetical order starting from left and reading clockwise. The U.S. ensign is displayed in the middle of the semicircle.

The display of the national ensign from various flagpoles is contained in NTP 13; as a general rule, the right side of a flagpole is determined by looking from the main entrance of a building towards the pole. Flagpoles at naval shore activities are topped with a brass ball of appropriate size.

Flag Size for Shore

The following dimensions may be used in determining the size of the ensign to be flown. A larger size is flown on Sundays and holidays and a smaller size flown daily if such a choice is available.

<u>Height of flagpole</u>	Recommended size
Less than 35 feet	#8 (3' 6" × 6' 7 3/4")
35 to 55 feet#	7 (5' × 9' 6")
Greater than 55 feet	#5 (8' 11 3/8" × 17')

Miscellaneous Information

The union jack is not displayed ashore. The church or Jewish pennant is not displayed above the national ensign ashore, but separately if desired. The following sites have been authorized to fly the national ensign 24 hours a day:

- U.S. Capitol, Washington, D.C.
- White House, Washington, D.C.
- Fort McHenry, Baltimore, Maryland
- Home of Betsy Ross, Philadelphia, Pennsylvania
- U.S. Marine Corps Iwo Jima Memorial, Arlington, Virginia
- Battle Green, Lexington, Massachusetts
- Washington Monument, Washington, D.C.

- Customs Ports of Entry

HOISTING AND LOWERING

The national ensign is never broken, but always hoisted briskly and smartly and lowered ceremoniously. The only exception to this practice is when the national ensign is hauled down briskly and smartly from the gaff as a ship shifts colors to the flagstaff when anchoring or mooring between the hours of 0800 and sunset. On board ships and crafts of the Navy, the union jack at the jackstaff is hoisted, lowered, and half-masted with the national ensign at the flagstaff.

HALF-MASTING THE ENSIGN

When half-masting the national ensign, it must, if not already hoisted, first be hoisted to the peak, then lowered to the half-mast position. Before lowering from half-mast, the flag must be hoisted to the peak and then lowered.

When the President directs that the national ensign be flown at half-mast at military installations and aboard ships, it must be flown at half-mast whether or not the ensign of another nation is flown close-up alongside the U.S. ensign.

When the national ensign is flown half-mast in ships or crafts of the Navy, the church or Jewish worship pennant, if flown, is hoisted just above the national ensign.

If holiday colors are to be displayed on days other than Sundays and holidays, or if colors are to be displayed at half-mast on days other than Memorial Day, the senior officer present, at 0745, hoists the appropriate signal. If such signal is hoisted after 0800, colors must be shifted or half-masted when the signal is hauled down. If half-masting is ordered during periods of dress or full-dress ship, only the national ensign at the flagstaff is half-masted.

NOTE

On board ship or at a shore command, upon all occasions of hoisting, lowering, or half-masting of the national ensign, the motion of the senior officer present must be followed except as prescribed for answering a dip or firing a gun salute.

Table 10-2 shows the occasions when the flag is half-masted as a symbol of mourning. As you can see by table 10-2, there are occasions when ships under

Table 10-2.—Occasions When the National Flag is Half-Masted as a Symbol of Mourning

Deceased Official	National flag half-masted	
	By—	Period
President, former President, or a President-elect.	All ships and stations of the Naval Establishment.	When displayed: For 30 days from the day of death.
Vice President, Chief Justice or retired Chief Justice of the United States, or the Speaker of the House of Representatives. do	When displayed: For 10 days from the day of death.
An Associate justice of the Supreme Court, a member of the Cabinet, a former Vice President, the Secretary of the Army, the Secretary of the Navy, or the Secretary of the Air Force. do	From the day of death until interment.
Governor of a state, territory, or possession.	All ships and stations in such state, territory, or possession. do
United States Senator, Representative, Territorial Delegate, or the Resident Commissioner from the Commonwealth of Puerto Rico.	All ships and stations in the metropolitan area of the District of Columbia. All ships and stations in the applicable state, congressional district, territory, or commonwealth.	From the day of death until interment.
Civil officials not listed above, but entitled to gun salute on official visit.	Ships and stations in the vicinity when directed by senior officer present or other competent authority to join in funeral honors.	When displayed: From 0800 till sunset on day of funeral.

Deceased	National flag half-masted		Personal flag or command pennant of deceased, commission pennant of ship command.
	By—	Period	
Chairman or former Chairman of the Joint Chiefs of Staff, United States military officer of 5-star rank, Chief or former Chief of Naval Operations, Commandant or former Commandant of the Marine Corps.	All ships and stations of the Department of the Navy.	From time of death until sunset of the day of the funeral.	Half-masted from time of death until sunset of day of funeral, or removal of the body, and then hauled down.
Flag or general officer (Marine) in command.	All ships present, not under way, and by naval stations in vicinity.	When displayed: From time of death until sunset of day of funeral, or removal of the body. do
Flag or general officer (Marine) not in command.	.. do ..	From the beginning of the funeral until sunset of that day. do
Unit commander not a flag officer; commanding officer.	.. do do ...	Half-masted from time of death until sunset of day of funeral, or removal of the body, and then hauled down; except commission pennant rounded up.
All other persons in the naval service.	.. do ..	During funeral and for 1 hour thereafter.	

way do not half-mast the ensign although those not under way do so. The ensign is also half-masted on the following occasions:

- The United States honors its war dead on Memorial Day by half-masting the flag from 0800 until the last gun of a 21-minute gun salute that begins at noon or until 1220 if no gun salute is rendered.
- During burial at sea, the ensign is at half-mast from the beginning of the funeral service until the body is committed to the deep. A longer period for displaying the ensign at half-mast may be prescribed, according to circumstances, by the senior officer present. Boats participating in a funeral procession also fly the national ensign at half-mast.

DIPPING THE NATIONAL ENSIGN

U.S. Navy Regulations stipulates that when any ship under United States registry or the registry of a nation formally recognized by the United States salutes a U.S. Navy ship by dipping its flag, the courtesy is to be returned, dip for dip. If a salute is rendered to a naval vessel when the ensign is not already displayed, such as before 0800 or after sunset (in port), the national ensign shall be hoisted for the

purpose of answering the dip and, after a suitable interval, hauled down. If displayed at half-mast, the national ensign must first be hoisted to the peak before answering the dip, then returned to half-mast after a suitable interval.

No U.S. Navy ship shall dip the national ensign unless in return for such compliment. U.S. naval ships (USNS) of the Military Sealift Command do not dip the national ensign to Navy ships, since they are public ships of the United States.

Formal recognition does not necessarily mean that diplomatic relations must exist. Moreover, the fact that diplomatic relations have been severed does not mean that the United States no longer recognizes the existence of the state or the government concerned.

According to the State Department (Protocol) listing of 6/86, the following governments (fig. 10-1) were not formally recognized by the United States and, therefore, are not entitled to a salute:

- Albania
- Angola
- Cuba

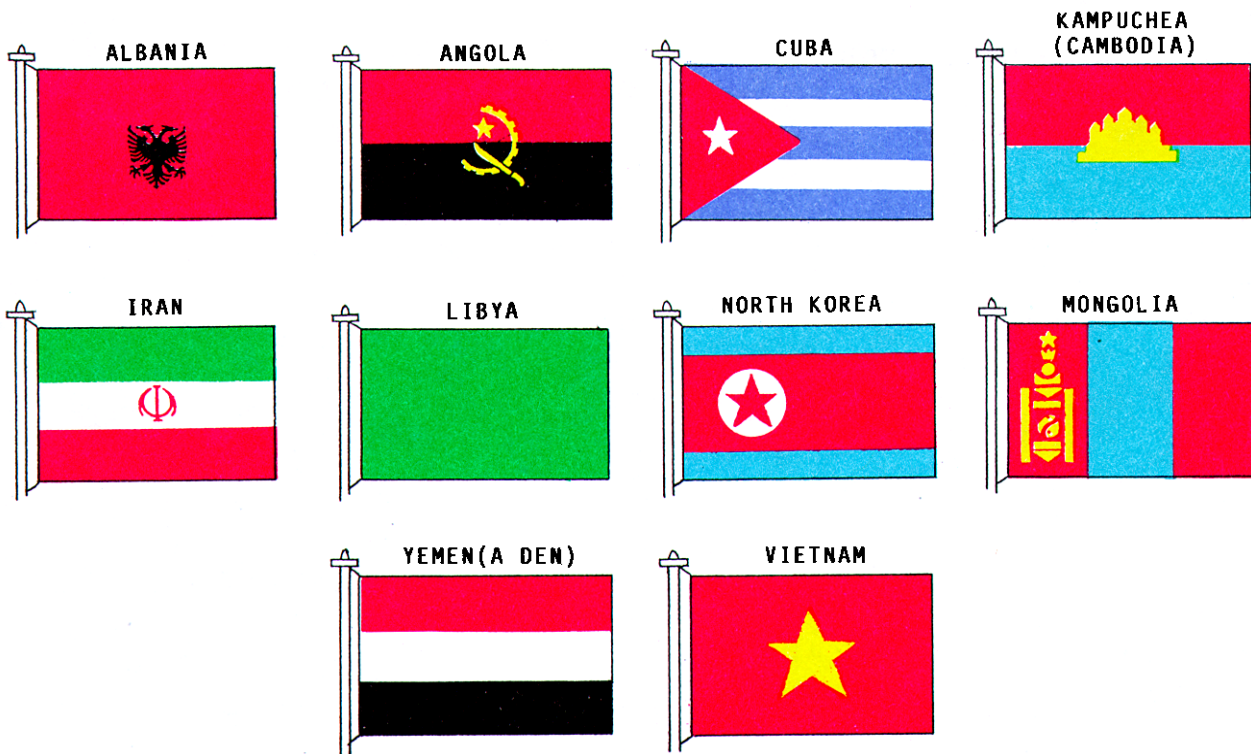

Figure 10-1.—Flags of nations not formally recognized by the United States.

Kampuchea

Iran

Libya

Mongolia

North Korea

South Yemen (Peoples Democratic Republic of)

Vietnam (Social Republic of)

Dips by yachts displaying a yacht ensign are also returned. The yacht ensign is similar in design to the U.S. ensign except that the blue field contains a white fouled anchor surrounded by 13 white stars.

Submarines, or such other ships of the line in which it would be considered hazardous for personnel to do so, are not required to dip the ensign.

Of the colors carried by a naval force on shore, only the U.S. Navy flag and the Battalion Colors are dipped in rendering or acknowledging a salute.

UNION JACK

The union jack, when displayed from the jackstaff, is the same size as the union of the ensign displayed from the flagstaff.

When a naval ship is not under way, the union jack is flown from the jackstaff from 0800 to sunset. It is also hoisted at the yardarm to indicate that a general court-martial or a court of inquiry is in session. It is hoisted when the court meets and is hauled down when the court adjourns.

When displayed from the jackstaff, the union jack is half-masted when the ensign is half-masted. It is not dipped, however, when the ensign is dipped in return for such honor being rendered it.

The union jack is flown in boats as follows:

- When a diplomatic representative of the United States of or above the rank of charge d'affaires is embarked in a boat of the U.S. Navy and is within the waters of the country to which he/she is accredited
- When a governor general or governor commissioned as such by the President is embarked in a boat in an official capacity and is within the area of jurisdiction (for example, the Governor of the Virgin Islands)

PERSONAL FLAGS AND COMMAND PENNANTS

LEARNING OBJECTIVES: Identify procedures for the displaying of personnel flags and command pennants from ships, shore commands, vehicles, and aircraft. Explain the use of the commission pennant.

Figure 10-2 shows personal flags, personal command pennants, and several miscellaneous flags and pennants.

The distinctive mark of a ship or craft in commission in the Navy is either a commission pennant, a personal flag, or a command pennant of an officer of the Navy eligible for command at sea. The distinctive mark of a Navy hospital ship in commission is the Red Cross flag.

Only one distinctive mark is displayed by a ship or craft at one time. If a personal flag, including that of a civil official, or command pennant goes up, the commission pennant comes down. Except as prescribed in *Navy Regulations* for certain occasions of ceremony, the distinctive mark must remain at the after masthead day and night or, in a mastless ship, from the loftiest and most conspicuous hoist. Ceremonial occasions may require the shifting of the distinctive mark to another masthead or to the starboard yardarm.

DISPLAY OF PERSONAL FLAGS AND COMMAND PENNANTS

A flag officer or unit commander afloat must display his/her personal flag or command pennant from his/her flagship. At no time must he/she display it from more than one ship. When a flag officer, eligible for command at sea, is embarked for passage in a ship of the Navy, his/her personal flag must be displayed from such ship unless there is already displayed a personal flag of an officer his/her senior.

There are any number of civil officials entitled to show personal flags that go with their offices. The flags of interest to a Signalman, however, are those belonging to civil officials whose personal flags are authorized for display during official visits. (Visits are discussed later in this chapter.) Personal flags of principal civil officials are shown in figure 10-3.

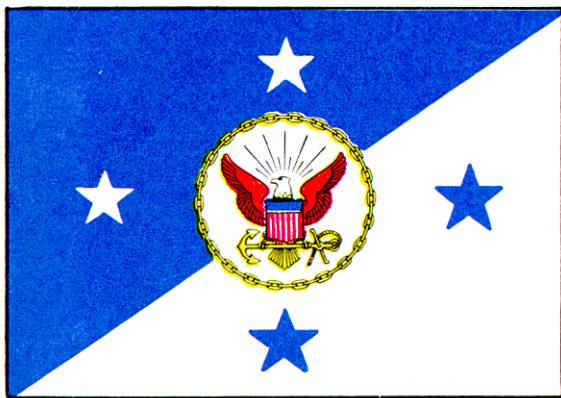

CHIEF OF NAVAL OPERATIONS

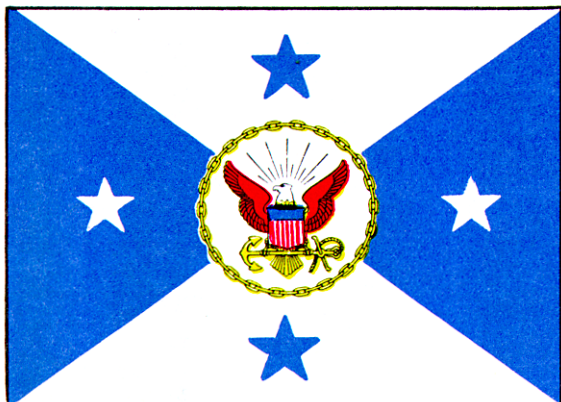

VICE CHIEF OF NAVAL OPERATIONS



FLEET ADMIRAL

ADMIRAL

VICE ADMIRAL

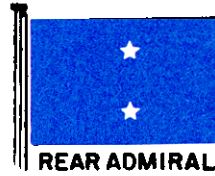

REAR ADMIRAL



COMMODORE

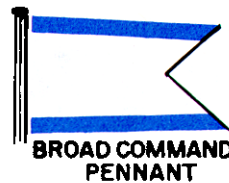

BROAD COMMAND
PENNANT



BURGEE COMMAND
PENNANT



COMMISSION PENNANT

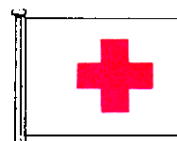

RED CROSS

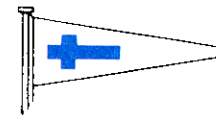

CHURCH PENNANT

Figure 10-2.—Personal flags and command pennants of officers eligible for command at sea.

The commission pennant is hauled down when the personal flags of the following civil officials are displayed at the main truck during official visits and during the time they are officially embarked for passage in a Navy ship:

- President
- Vice Resident
- Secretary of State, when acting as a special foreign representative of the President
- Secretary, Deputy Secretary, and Assistant Secretaries of Defense
- Secretary, Under Secretary, and Assistant Secretaries of the Navy

When more than one civil official is aboard, only the flag of the senior is displayed.

RESTRICTIONS

A ship under way must not display a personal flag or command pennant unless a flag officer or unit commander is aboard. Should a flagship get under way during the absence of the flag officer, the personal flag or command pennant is hauled down and replaced with a commission pennant. Should the flag officer or unit commander depart his/her ship at sea for a brief call to another ship, his/her personal flag or command pennant should remain hoisted.

A personal flag or command pennant may be hauled down during battle or at any time the officer



The President



Vice President



Secretary of State



Secretary of the Treasury



Secretary of Defense



Secretary of the Navy



Secretary of the Army



Secretary of the Air Force



Attorney General



Postmaster General



Secretary of the Interior



Secretary of Agriculture

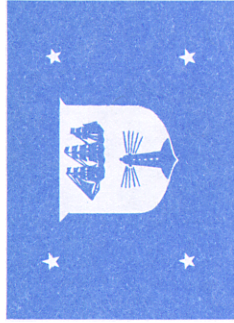

Secretary of Commerce



Secretary of Labor

Figure 10-3.—Personal flags of civil officials of the United States.

concerned, or the senior officer present, considers the need to render the flagship less distinguishable. If hauled down, it will be replaced with a commission pennant.

Personal flags or command pennants of military officers other than U.S. naval officers eligible for command at sea are not displayed from ships or crafts of the U.S. Navy.

An officer of the Navy commanding a ship engaged otherwise than in the service of the United States must not display a personal flag, command pennant, or commission pennant from such ship or in the bow of a boat.

BROAD AND BURGEE COMMAND PENNANTS

Personal command pennants of an officer of the Navy, not a flag officer, commanding a unit of ships or aircraft are of two types: broad and burgee. A broad command pennant indicates command of

1. A force, flotilla, squadron, or group of ships of any type (PHIBGRU, DESRON), or
2. An aircraft wing.

The burgee command pennant indicates command of a division of ships other than aircraft carriers or cruisers, or a major subdivision of an aircraft wing.

The broad and burgee command pennants are shown with numerals to indicate the organizational number of the command within a type, when numerals are assigned. When two commanders within a type are entitled to display the same command pennant and have the same organizational number, the senior of the two uses Roman numerals on the pennant. In all other cases, Arabic numerals are used. For more information concerning the use of the broad and burgee command pennants, refer to NTP 13, chapter 9.

SIZE OF PERSONAL FLAGS AND COMMAND PENNANTS

A vessel under 600 feet in length shall display a size 6 command pennant or a size 7 personnel flag. A vessel 600 feet or greater in length shall display a size 4 command pennant or a size 6 personal flag.

DISPLAY OF TWO PERSONAL FLAGS SIMULTANEOUSLY

When the personal flag of a civil official is displayed aboard a ship or craft of the Navy, the personal flag or command pennant of the embarked commander must be displayed as follows:

- Aboard a single-masted ship, at the starboard yardarm
- Aboard a two-masted ship, at the fore truck
- Aboard a ship with more than two masts, at the after mast

When the personal flag of a civil official and the personal flag or command pennant of an officer of the Navy are displayed at the starboard yardarm, the flag of the civil official shall be displayed outboard.

DISPLAY OF A PERSONAL FLAG AND PENNANT WHEN NATIONAL ENSIGN IS AT MASTHEAD

The President's flag, if displayed at a masthead where the national ensign is required to be displayed during an official visit or during periods of dress or full-dress ship, must remain at that masthead to port of the United States ensign and to starboard of a foreign national ensign.

Except as just mentioned, a personal flag or command pennant must not be displayed at the same masthead with the ensign, but should be displayed as follows:

- During periods of dressing or full-dressing, if displayed from the fore truck or from the masthead of a single-masted ship, it should be shifted to the starboard yardarm; if displayed from the main truck, the personal flag or command pennant is shifted at the fore truck in lieu of the national ensign at that mast; and if displayed from the after truck of a ship with more than two masts, it remains at the after truck in lieu of the national ensign.

- During gun salutes in which the ensign is hoisted at the main truck, however, the personal flag or pennant is simply lowered clear of the ensign.

- During an official visit, the personal flag or command pennant is shifted to the starboard yardarm in a single-masted ship and to the fore truck in a two-masted ship.

**ASHORE DISPLAY OF PERSONAL
FLAGS AND COMMAND
PENNANTS**

Personal flags and command pennants are flown day and night at a suitable and conspicuous place at naval shore installations. When the points for display of two or more personal flags ashore are in such close proximity as to make their separate display inappropriate, that of the senior officer is displayed. When two officials entitled to display personal flags are at the same command, only the senior officer displays his/her flag.

Official Visits

During an official visit by a foreign president or sovereign, the national ensign of that nation is flown during the visit. A visit by any other foreign officials requires the display of the foreign national ensign or personal flag during the gun salute only, as follows:

- If the foreign visitor is a military official or officer, his/her personal flag, if provided, is flown during the salute and from automobiles. If no flag is provided, the foreign ensign of such nation is flown during the salute, and an equivalent personal flag of a U.S. naval officer may be flown from automobiles, and a comparable plate shown on a military plane transporting the dignitary.
- U.S. personal flags for specific positions (CNO, VCNO) are not used for foreign visitors. In these cases, either the military rank equivalent flag or foreign national ensign is used for colors.
- During all first official visits for foreign service chiefs, the rank of the visitor is equal to that of his/her U.S. counterpart. Therefore, a U.S. Navy line officer four-star flag is flown for foreign navy Chiefs (instead of the CNO personal flag), regardless of the foreign service chiefs' rank.

**Flagpole Configurations and
Size of Flags Flown**

The following information is provided in selecting the proper halyard for displaying a personal flag or command pennant with the U.S. flag:

Polemast—Personal flag/command pennant not flown

Polemast with Crosstree—Outermost halyard, right-hand crosstree

Polemast with Gaff—Peak of pole

Polemast with Crosstree and Gaff—Peak of pole

Now that you know the proper halyards for the display of the personal flag and command pennant, you now must know what size to use. The following information indicates the appropriate size of personal flag or command pennant to be flown at shore activities from flagstuffs of various height.

Flagstaff height	Personal Flag	Broad/Burgee
Less than 35 feet	#7 1'10" by 2'8"	#8 1'2" by 1' 6"
Greater than 35 feet	#6 3'7" by 5' 1 1/2"	#6 2' by 2' 7"

PERSONAL FLAGS ON VEHICLES

An officer entitled to display a personal flag or command pennant may, when riding in a government vehicle on official occasions, display such flag or pennant forward on the vehicle. The staff used for vehicle flags is topped by an acorn, regardless of the rank of the official or officer in the vehicle.

All flag officers are authorized to show stars of their rank on their assigned vehicle. The method of showing such stars should be plates resembling civilian license plates in shape and size. Coloring will correspond to that of the personal flag. Personal flags must not be painted on the vehicle.

PERSONNEL FLAGS ON AIRCRAFT

Civil and military official aircraft plates are facsimiles, less fringe, of individual personal flags of the official concerned, reduced in scale and reproduced on a metal plate, 11 by 14 inches. Normally, the civil or military official's aide will be responsible for ensuring that the individual's aircraft plate is available for display.

Personal flags may also be printed on aircraft assigned to flag officers acting in flag billets. Sheet metal replicas inserted in metal slots are also authorized. The flag should be located on each side of the forward fuselage and must conform in size.

NTP 13 contains a list of personnel authorized to display a personal flag from an aircraft.

COMMISSION PENNANT

With exceptions already noted, the commission pennant is the distinctive mark of a Navy ship in

commission that has no flag officer or other unit commander embarked. The pennant is flown at the after truck or, on a mastless ship, at the highest and most conspicuous point of hoist.

Although the commission pennant is not a personal pennant, it is sometimes regarded as the personal symbol of the commanding officer. Along with the ensign and union jack, it is half-masted upon the death of the commanding officer. It remains at half-mast until sunset of the day of the funeral or until the body is removed from the ship.

DRESSING AND FULL-DRESSING SHIP

LEARNING OBJECTIVE: Explain procedures for dressing and full-dressing ship. Explain actions to be carried out when dressing and full-dressing in port, under way, when half-masting, and dipping.

When dressing or full-dressing ship, the largest national ensign with which the ship is furnished is displayed from the flagstaff and, except as prescribed for a ship displaying a personal flag or command pennant, a national ensign is displayed from each masthead. The national ensigns displayed at the mastheads should be of uniform size but smaller than the one at the flagstaff. If there is a substantial difference in heights of mastheads, however, a difference in the size of the national ensigns is appropriate.

When the ship is full-dressed, mastheads are dressed as described in the preceding paragraph. In addition, a rainbow of signal flags is displayed, reaching from the foot of the jackstaff to the mastheads, then to the foot of the flagstaff. Peculiarly masted or mastless ships make a display as little modified from the rainbow effect as possible. The rainbow is displayed in the order prescribed in NTP 13.

Ships not under way are dressed or full-dressed from 0800 until sunset. Ships under way are not dressed or full-dressed. Ships operated by the Military Sealift Command (MSC) are not required to be full-dressed, but will dress ship when full-dress is specified and on all occasions of dress ship.

Ships are full-dressed on the third Monday of February (President's Day) and the Fourth of July (Independence Day). When the Fourth of July falls on

a Sunday, ceremonies are conducted the following day. Ships are dressed on the remaining national holidays. Ships may be full-dressed or dressed at such other times as may be prescribed.

When dressing or full-dressing ship in honor of a foreign nation, the national ensign of that nation replaces the United States national ensign at the main, or the masthead in a single-masted ship.

Should the occasion arise whereby the ensign is to be half-masted or dipped during dress or full-dress ship, only the national ensign at the flagstaff is half-masted or dipped.

When full-dressing is prescribed, the senior officer present may direct that dressing be substituted if the state of the weather makes such action advisable. The senior officer present may also exempt ships undergoing shipyard and/or repairs from dress or full-dress ship.

Only clean flags should be used in full-dressing ship. On large ships, more than one set of flags may be needed to fill all the dressing lines. Flags should be stopped to the dressing lines the day before the ship is to be full-dressed, otherwise something unforeseen might develop and the dressing lines would not be ready for hoisting at 0800.

The ensigns, jack, and rainbow of flags should be hoisted smartly at 0800. At evening colors, all ensigns and the jack should be lowered ceremoniously. The rainbow of flags should be lowered quickly.

COLORS

LEARNING OBJECTIVES: Explain the procedures for conducting colors ceremony and sunrise.

The ceremonial hoisting and lowering of the national flag at 0800 and sunset at commands ashore and aboard ships of the Navy not under way is known as morning and evening colors. The guard of the day and the band, if available, are in the vicinity of the point of hoist.

Aboard Navy ships or naval shore activities on all occasions of hoisting and lowering or half-masting the national ensign, the motions of the senior officer present are to be followed. Five minutes before morning and evening colors, at first call, the PREPARATIVE pennant is hoisted. Ceremonies for colors begin when the pennant is hauled to the dip.

If a band is available for colors ceremonies, “Attention” is sounded, followed by the band playing the national anthem. In the morning, the ensign is started up at the beginning of the music and hoisted smartly to the peak or truck. At evening colors, the ensign is started down at the beginning of the music; lowering is so regulated as to be completed at the last note of the music. The national flag always is hoisted smartly and lowered ceremoniously. “Carry on” is sounded at the completion of the music.

If no band is aboard, “To the Colors” is played on the bugle at morning colors, and “Retreat” at evening colors. For ships having neither a band nor a bugler, whistle signals are used to call attention to colors; a single blast indicates “Attention,” and those not in rank render the hand salute. At the conclusion of colors, three short blasts mean “Carry on.”

Voice commands are used only as a last resort. The words *attention to colors* and *carry on* are passed on the ship's 1MC. The hand salute is rendered as described for whistle signals.

When the music from another ship can be heard during colors and there is no band or bugler aboard your ship, the command to “Carry on” should not be given until the music being overheard is completed.

After morning colors, if foreign warships are present, the national anthem of each nation so represented should be played in the order in which a gun salute would be fired to, or exchanged with, the senior official or officer present of each nation. When in a foreign port, however, the national anthem of the port should be played immediately after morning colors, followed by the national anthems of the other foreign nations represented. A schedule of the English alphabetical order of the members of the United Nations is listed in Annex B of NTP 13.

For sunrise procedure, the PREPARATIVE pennant is hoisted close up 5 minutes before sunrise and hauled down at sunrise. At this time all deck lights are also turned off and appropriate flags hoisted.

FLAG DISPLAYS IN BOATS

LEARNING OBJECTIVES: Explain procedures for the display of the ensign, personal flags, and pennants in boats. List day and night procedure for conducting boat hails, and explain boat flagstaff topping ornaments.

The ensign is displayed at the stern of waterborne boats of the naval service as follows:

- When under way during daylight in a foreign port
- When ships are required to be dressed or full-dressed
- When going alongside a foreign vessel
- When an officer or official is embarked on an official occasion
- When a flag or general officer, a unit commander, a commanding officer, or a chief of staff, in uniform, is embarked in a boat of the command or in one assigned for personal use
- At other times when prescribed by the senior officer present

PERSONAL FLAGS AND PENNANTS

When an officer in command (or chief of staff) entitled to a personal flag or command pennant is embarked in a boat on an official occasion, the appropriate flag or pennant is flown at its bow. If the officer is not entitled to a personal flag or pennant, a commission pennant is displayed. On other than official occasions, a miniature personal flag or pennant is displayed near the coxswain's station.

Bow Marking

Boats also carry bow markings indicating to whom the boat is assigned. A boat having an arrow at the bow is assigned for use by a commanding officer or a chief of staff who is not a flag officer. A miniature of the command pennant is on the bow of a boat assigned to a unit commander. A boat assigned for the personal use of a flag or general officer has on each bow the number of stars corresponding to the officer's rank.

Union Jack

In the waters of the nations to which he/she is accredited, a diplomatic representative of or above the rank of charge d'affaires and a governor or governor general commissioned by the President are entitled to display the union jack within his/her area of jurisdiction.

BOAT HAILS

Boat hails are used during hours when honors are rendered (sunrise to sunset). The OOD should challenge an approaching boat as soon as possible by raising a clinched fist in the direction of the boat. He/she should also train a long glass or binoculars on the coxswain. The coxswain replies to this challenge by holding up the number of fingers corresponding to the number of side boys required to honor the senior official or officer on board.

Boats approaching a Navy ship between the hours of sunset and sunrise should be hailed as soon as

within hearing distance with "Boat ahoy." The coxswain then replies with the appropriate word or phrase from table 10-3 to indicate the highest official or officer on board.

FLAGSTAFF TOPPING ORNAMENTS

A staff ornament must top the flagstaff upon which the national ensign is displayed in boats of the naval service when an officer or civil official is embarked on an official occasion or when a flag officer, unit commander, commanding officer, chief of staff, or chief staff officer, in uniform, is embarked in

Table 10-3.—Boat Coxswain's Reply to Challenge

OFFICER OR OFFICIAL ABOARD BOAT	COXSWAIN'S REPLY
President or Vice President of the United States	United States
Secretary, Deputy or an Assistant Secretary of Defense	Defense
Secretary, Under Secretary or an Assistant Secretary of the Navy	Navy
Chairman of the Joint Chiefs of Staff	Joint Chiefs of Staff
Chief of Naval Operations or the Vice Chief of Naval Operations	Naval Operations
Fleet, Force, or Type Commander	_____ Fleet or abbreviation of administrative title, i.e., PACFLT.
A Flag Office	Flag Office
A Chief of Staff/Chief Staff Officer	Staff
A Flotilla/Group Commander	* _____ Flot/Gru _____ (type) (number)
A Squadron Commander	* _____ Ron _____ (type) (number)
A Division Commander	* _____ Div _____ (type) (number)
A Marine Officer Commanding a Brigade	Brigade Commander
A Commanding Officer of a Ship or Station	_____(Name of Ship or Station)
A Marine Officer Commanding a Regiment	Regiment Commander
Any Other Commissioned Officer	Aye, Aye
Other Officers (Not Commissioned)	No, No
Enlisted	Hello
A boat not intended to go alongside, regardless of rank of passenger	Passing
* The type abbreviation used, for example, is CRUDESGRU FIVE, SERVGRU ONE, PHIBRON SIX and MINEDIV TWO TWO	

a boat of his/her command or one assigned for his/her personal use. An additional staff ornament of the same type must top the flagstaff in the bow upon which the personal flag, command pennant, or commission pennant is displayed.

Figure 10-4 shows sketches of the different ornaments used today by the Navy. The topping ornament must have a highly polished brass finish. See NTP 13, chapter 11, for rules governing the display of flagstaff topping ornaments.

HONORS

LEARNING OBJECTIVES: Explain the procedures for conducting passing honors, side honors, honors for official visits, and honors on relief of command. List occasions when honors can be dispensed with.

In this section, we explain the different procedures used for conducting the different types of honors.

PASSING HONORS

In some cases, the distinctive mark flown from a ship indicates the grade of the senior line officer on board and, thus, is a means of determining who should initiate passing honors. The commanders in chief of the Atlantic and Pacific Fleets periodically issue a list of ships and subdivisions of the fleet with the name and lineal number of each commanding officer and commander. The list helps determine who should initiate honors, but because unit commanders occasionally ride other ships, Signalmen must be alert to distinctive marks being flown.

Passing honors are those honors other than gun salutes that are rendered on occasion between Navy and/or Coast Guard ships or embarked officials or officers that pass, or are passed, close aboard. Close *aboard* means passing within 600 yards for ships and

400 yards for boats, but both frequently are extended to ensure that appropriate honors are rendered.

Sequence for Rendering Passing Honors

Most frequently, passing honors consist of saluting the ship or official passing. When the bow of a ship passes the bow or stern of another commissioned ship or boat, attention to the appropriate side is called by sounding one or two whistles over the 1 MC. All hands in view on that side and not in ranks face outboard. "Hand salute" is sounded. When the other ship or the official returns the salute, "Two" and then "Carry on" are sounded. Bugle, whistle, and passing the word are used for passing honors, with bugle being the preferred method. Bugle or whistle signals are as follows:

- One blast—Attention to starboard
- Two blasts—Attention to port
- One blast—Render salute
- Two blasts—Terminate salute, remain at attention
- Three blasts—Carry on

In addition, the honors prescribed in table 10-4 are rendered by a ship of the Navy passing close aboard a ship or naval station displaying the flag of the official indicated and by a naval station, when practicable, when a ship displaying such a flag passes close aboard. These honors, and all honors between ships, are acknowledged by rendering the same honors in return.

The honors prescribed in table 10-5 are rendered by a ship of the Navy passing or being passed close aboard by a boat displaying the flag of a civil official indicated. Honors to Armed Forces officers displaying a personal flag or command pennant from the bow of a boat are the same as those for passing Navy ships.

When a ship of the Navy is passing the USS *Arizona* Memorial, Pearl Harbor, Hawaii, between sunrise and sunset, passing honors consisting of sounding "Attention" and rendering the hand salute by

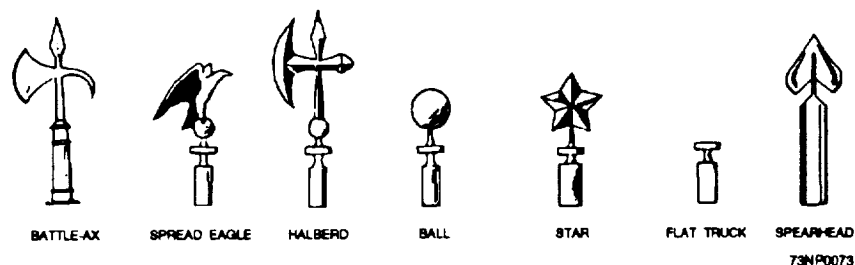

Figure 10-4.—Flagstaff topping ornaments.

Table 10-4.—Passing Honors Between Ships

Official	Uniform	Ruffles and Flour-ishes	Music	Guard	Remarks
President	As prescribed by the senior officer present	4			Man rail, unless otherwise directed by the senior officer present
Secretary of State, when special foreign representative of the President	As prescribed by the senior officer present	4	National Anthem	Full	Crew at quarters
Vice President	Of the day		Hail Columbia	Full	Crew at quarters
Secretary of Defense, Deputy Secretary of Defense, Secretary of the Navy, or Under Secretary of Defense	Of the day		National Anthem	Full	Crew at quarters
An Assistant Secretary of Defense, Under Secretary or an Assistant Secretary of the Navy	Of the day		National Anthem	Full	Crew at quarters

Table 10-5.—Passing Honors Between Boats

Official	Ruffles and Flour-ishes	Music	Guard	Remarks
President	4	National Anthem	Full	“Attention” sounded, and salute by all persons in view on deck. If directed by the senior officer present, man rail.
Secretary of State, when special foreign representative of the President	4	National Anthem	Full	“Attention” sounded, and salute by all persons in view on deck.
Vice President		Hail Columbia		“Attention” sounded, and salute by all persons in view on deck.
Secretary of Defense, Deputy Secretary of Defense, Secretary of the Navy, or Under Secretary of Defense, an Assistant Secretary of Defense, Under Secretary or an Assistant Secretary of the Navy		Admiral's March	Full	“Attention” sounded, and salute by all persons in view on deck.
Other civil official entitled to honors on official visit				“Attention” sounded, and salute by all persons in view on deck.

all persons in view on deck and not in ranks must be executed by that ship.

Honors to officers or officials embarked in boats are acknowledged by the officer or official through a hand salute or other mark of respect.

When a boat bearing a senior passes, passing honors are rendered. If a junior but a commanding officer, unit commander, or flag officer on an official occasion passes, personnel on the quarterdeck only will salute. This is a mark of respect to a person who holds command at sea.

Dispensing with Passing Honors

Passing honors are not rendered after sunset or before 0800 except when international courtesy requires such action. They are not exchanged between ships of the Navy engaged in tactical evolutions outside port.

The senior officer present may direct that passing honors be omitted in whole or in part.

Passing honors are not rendered by or required of ships with small bridge areas, such as submarines, particularly when in restricted waters.

Passing Honors to Foreign Dignitaries and Warships

Honors prescribed for the President of the United States are rendered by a ship of the Navy being passed close aboard by a ship or boat displaying the flag or standard of a foreign president, sovereign, or member of a reigning family except that the foreign national anthem is played instead of the national anthem of the United States.

SIDE HONORS

Side honors are rendered to foreign officers, civil officials, and all U.S. officers boarding and departing the ship, when directed by the senior officer present; the side is piped and the appropriate number of side boys paraded. Officers appropriate to the occasion attend the side on the arrival and departure of officials and officers.

Side honors are not rendered between sunset and 0800, during meal hours, or on Sundays. Side boys are not paraded on Sundays; on other days between sunset and 0800; or during meal hours of the crew, general drills and evolutions, and periods of regular overhaul except in honor of civil officials or foreign officers,

when they may be paraded at anytime during daylight. Side boys are paraded only on scheduled visits.

Except for official visits and other formal occasions, side boys are not paraded in honor of officers of the armed services of the United States unless otherwise directed by the senior officer present.

Side boys are not paraded in honor of an officer of the armed services in civilian clothes unless such officer is acting in an official civil capacity.

The side shall be piped when side boys are paraded, but not at other times.

Side honors also may be rendered as a part of naval courtesy to officers and officials on occasion other than official visit. Once the honors are rendered, it becomes an official visit, modified by the senior officer present.

HONORS FOR OFFICIAL VISITS

Articles in *U.S. Navy Regulations* detail honors for official visits by military and civil officials arriving and departing.

Arriving

Honors prescribed for an official visit are rendered on arrival as follows:

1. When the rail is manned, men/women shall be uniformly spaced at the rail on each weather deck, facing outboard.

2. "Attention" is sounded as the visitor's boat or vehicle approaches the ship.

3. If an arrival gun salute is prescribed, it is fired as the visitor approaches and still is clear of the side. The proper flag or pennant is broken on the first gun, and hauled down on the last gun except when it is to be flown for the duration of the visit. Other ships firing a concurrent salute, on the last gun should haul down the flag or pennant displayed in the honor of the visitor. If the ship visited is moored in such a position that it is not practicable to render the gun salute before the visitor arrives on board, the salute is rendered (provided local regulations do not forbid gun salutes) after the official and party have arrived on board and are in a position well clear of the saluting battery.

4. The boat or vehicle is piped as it comes alongside.

5. The visitor is piped over the side; all persons on the quarterdeck salute and the guard presents arms until

termination of the call, ruffles and flourishes, music, or gun salute, depending on which is the last rendered. If a gun salute is not prescribed on arrival but a flag or pennant is to be displayed during the visit, it is broken at the start of the call.

6. Piping of the side, ruffles and flourishes, and music are rendered in that order. In the absence of a band, "To the Colors" is sounded on the bugle in lieu of the national anthem, when required.

7. The visitor, if entitled to 11 guns or more, is invited to inspect the guard upon completion of honors.

Departing

Departure honors for an official visit are as follows:

1. The rail is manned, if required.
2. "Attention" is sounded as the visitor arrives on the quarterdeck.
3. When the visitor is ready to leave the ship, the guard presents arms; all persons on the quarterdeck salute; and ruffles and flourishes, followed by music, are rendered. The visitor is then piped over the side. The salute and present arms terminate with the last note of the call. If no salute is to be fired, the flag or pennant displayed in honor of the visitor is hauled down.
4. The boat or vehicle is piped away from the side.
5. If a gun salute is prescribed on departure, it is fired when the visitor is clear of the side. If a flag or pennant is displayed in honor of the visitor, it is hauled down with the last gun of the salute.

The same honor and ceremonies as for an official visit to a ship of the Navy is rendered, insofar as practicable and appropriate, on the occasion of an official visit to a naval station, except that manning the rail, piping the side, and parading side boys are not considered appropriate. When, in the opinion of the senior officer present, such honors will serve a definite purpose, they may be rendered.

Signalman's Duties

The Signalman's responsibilities for honors during official visits are the proper display of flags or pennants. That entails some advance planning and coordination to ensure a snappy evolution.

A basic rule for the display is that only one distinctive mark may fly from a ship. Thus, if the person visiting is an officer eligible for command at

sea who rates a personal flag or command pennant, the personal flag flies in lieu of the commission pennant. If the ship visited is a flagship and the officer visiting is senior to the commander of the unit and rates a personal flag or command pennant, the personal flag or command pennant of the officer visiting flies in lieu of the unit commander's personal flag or pennant. The flag or pennant of an officer not eligible for command at sea is not displayed from a ship of the Navy.

The Red Cross flag is never replaced. The flying of the personal flag of an officer eligible for command of a warship at sea violates the neutrality of the provisions of the Geneva Convention.

In addition to the rule that only one distinctive mark may be displayed at one time, the commission pennant and personal flag of a civil official may not be displayed simultaneously. When a civil official in whose honor the display of a personal flag is prescribed pays an official visit or embarks for passage, the personal flag is displayed at the after masthead or most conspicuous hoist, replacing the distinctive mark. If the mark is a commission pennant, it is immediately lowered; if it is an officer's personal flag or command pennant, it is shifted, as explained earlier in this chapter.

Visits during dress ship also provide variations in displaying personal flags and command pennants. Check *U.S. Navy Regulations* and NTP 13 for details.

HONORS ON RELIEF OF COMMAND

When a flag officer or a unit commander relieves a command or departs after being relieved, the same honors are rendered as for an official visit, subject to regulations pertaining to gun salutes.

When assuming a command, an officer reads his/her orders to the assembled officers and crew. Immediately after reading the orders, the officer's personal flag or command pennant is broken, and a gun salute, if required, is fired.

If the flag officer or unit commander is relieving another officer in command, the officer being relieved reads his/her orders to the assembled officers and crew. On completion thereof, or after the gun salute, if fired, the commission pennant is hoisted and the personal flag or pennant immediately lowered. The officer succeeding to command then reads his/her orders, and on completion thereof, the flag or command pennant is broken and the ship's commission pennant is hauled down.

An important point of the relieving ceremony as it pertains to a Signalman is that the ship's distinctive mark always be in the air. There are occasions, for example, when commanding officers (below flag rank) being relieved are presented with the ship's commission pennant. When such a presentation is to be made, a new commission pennant must be closed up before the one to be presented is hauled down.

HONORS FOR OFFICIAL INSPECTION

When a flag officer or unit commander boards a ship of the Navy to make an official inspection, honors are rendered as for an official visit. The flag or pennant is broken upon arrival and is hauled down on departure. When the flag of a flag officer or unit commander is flying on board the vessel being inspected, his/her personal flag is hauled down on board the flagship unless the latter is the vessel being inspected.

The same provisions apply, insofar as practical and appropriate, when a flag officer in command ashore makes an official inspection of a unit of his/her command.

HONORS FOR FOREIGN MILITARY OFFICERS AND CIVIL OFFICIALS

Honors rendered to foreign military officers and civil officials are essentially the same as those for United States officers and civil officials of the same rank. A foreign naval officer's flag is not, however, displayed from a U.S. Navy ship. Flags pictured in figure 10-5 are shown for the purpose of recognition and as an aid in determining relative seniority for rendering passing honors and the like.

The national ensign of the foreign country is flown from a U.S. Navy ship when visited by a foreign officer or civil official. If the official is entitled to a 21-gun salute, the foreign ensign is flown from the main masthead. If entitled to fewer than 21 guns, it is flown from the foremast. The personal flag or command pennant normally displayed at the main would be moved to another location, as mentioned earlier for U.S. civil officials.

MISCELLANEOUS FLAGS AND PENNANTS

LEARNING OBJECTIVE: Explain the use of the following flags and pennants: U.S. Navy flag, United Nations flag, homeward-bound pennant, church or Jewish worship pennant, Red Cross flag, the POW/MIA flag, award flags and pennants, and the absentee pennants.

The use of the following flags is a must-know for all Signalmen; take a little time and learn the procedures for their display.

U.S. NAVY FLAG

On 24 April 1959, the President, on the recommendation of the Secretary of the Navy, established an official flag (fig. 10-6) for the United States Navy. That was done to fulfill a need for an official flag to represent the Navy on a variety of ceremonial, parade, and display occasions.

The U.S. Navy flag represents the Navy as follows:

- At Official ceremonies
- In parades
- During official Navy display occasions
- At public gatherings when the Navy is an official participant
- On other occasions as may be authorized by the Secretary of the Navy

When used for these purposes, the Navy flag accompanies and takes the place of honor after the national flag. However, when other branches of the Armed Forces are participating, the flags take precedence in order of seniority of the services represented.

UNITED NATIONS FLAG

The flag of the United Nations consists of the official emblem of the United Nations in white centered on a "United Nations blue" field (fig. 10-7).

The flag is flown from all buildings, offices, and other property occupied by the United Nations. The manner and circumstances of display conform, as far as appropriate, to the laws and customs applicable to the display of the national flag of the country in which the display is made.

The United Nations flag is displayed at installations of the Armed Forces of the United States only upon occasions of visits of high dignitaries of the United Nations while in performance of their duties with the United Nations. When so displayed, it is displayed with the U.S. flag; both flags should be of approximately the same size and on the same level, with the flag of the United States in the position of honor on the right, the observer's left.

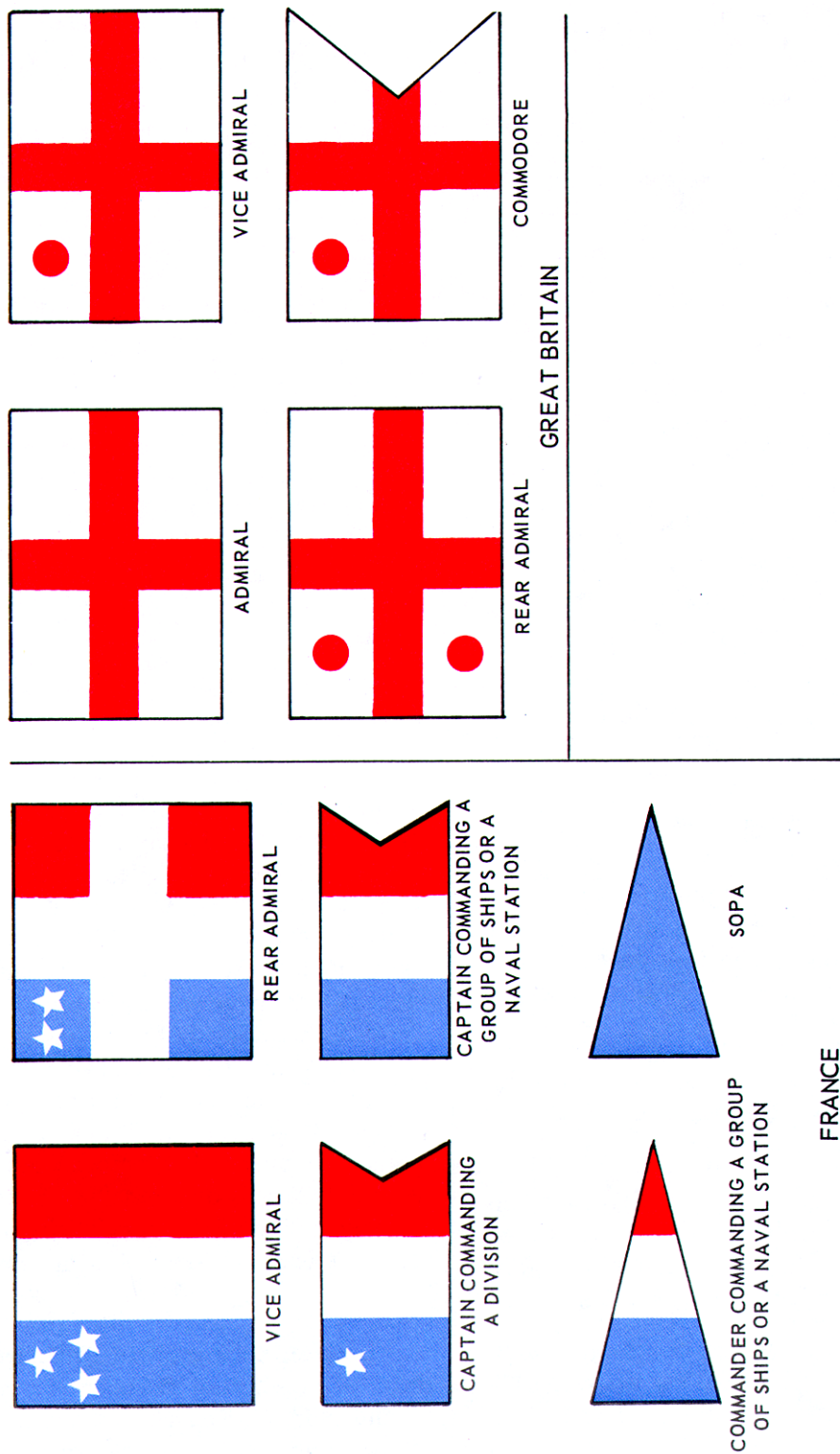

Figure 10-5.—Personal flags of major naval powers.

THIS PAGE MUST BE PRINTED ON A COLOR PRINTER.

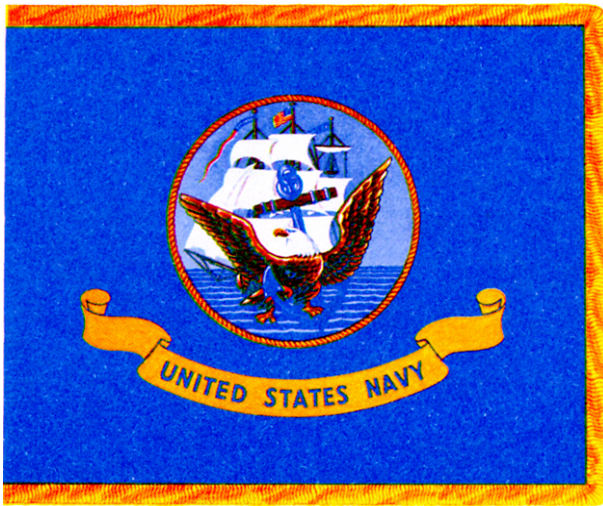

Figure 10-6.—United States Navy flag



Figure 10-7.—United Nations flag.

When United Nations dignitaries are to be honored, U.S. Navy vessels display the United Nations flag in the same manner as they present a foreign ensign during visits of a foreign president or sovereign.

The President of the United States may authorize the display of the United Nations flag for national occasions other than those named.

Flags, Pennants and Customs, NTP 13, contains instructions for the display of, restrictions, and prohibitions for the United Nations flag. The following list contains a few of the regulations:

- The United Nations flag may be displayed alone or with other national flags to demonstrate support of the United Nations and to further its principles and purpose.

- When it is displayed with one or more other flags, all flags displayed are flown on the same level and should be of approximately equal size.

- It may be displayed on either side of any other flag without being in a subordinate position to such flag.

- On no account may any flag displayed with the United Nations flag be on a higher level than the United Nations flag, and on no account may any flag displayed with the United Nations flag be larger than the United Nations flag.

- The flag ordinarily is displayed from sunrise to sunset, but it may also be displayed at night upon special occasions.

- The United Nations flag should never be used as a drapery of any sort, nor festooned, drawn back, up, or in folds, but always allowed to fall free.

In a closed circle, a cluster, or a linear or semicircular grouping of flags of the United Nations, flags other than the United Nations flag are displayed in the English alphabetical order of the countries represented, starting from the left and reading clockwise. The United Nations flag may be displayed on a flagpole in the center of a circle of flags or in the center of a line cluster or semicircular display.

HOMeward-BOUND PENNANT

The homeward-bound pennant is flown by ships returning from extended overseas tours. The pennant is authorized for display by a ship that has been on duty outside the limits of the United States continuously for at least 9 months. It is hoisted on getting under way for the United States and may be flown until sunset on the day of arrival in a port of destination. The pennant is similar to the commission pennant, but instead of the usual seven stars, there is one star for the first 9 months of overseas duty and one star for each additional 6 months. Total length of the pennant customarily is 1 foot for each officer and enlisted crewmember who served overseas for a period in excess of 9 months. When the number of personnel produces an unwieldy pennant, the length of the pennant is restricted to the length of the ship.

Upon arrival in a port of the United States, the blue portion containing the stars is presented to the commanding officer. The remainder of the pennant is divided equally among the officers and enlisted crew.

RED CROSS FLAG

The Red Cross (Geneva Convention) flag is the distinctive mark flown from the after truck of a hospital ship of the Navy in commission.

In general, the Red Cross flag is regarded as an international guarantee of amnesty from attack. It is displayed ashore at the sanitary branch (dispensary or infirmary) of an activity of the Navy, in company with the national flag, to indicate that the area immediately surrounding it is entitled to protection under the rules of the Geneva Convention. None of the military services, however, flies it on the same halyard as the national flag. Boats engaged in sanitary service and landing party hospital boats display the Red Cross flag from a staff in the bow.

Some nations in the Middle East regard the cross as a symbol contrary to their religious beliefs. Instead of a red cross on the flag, they use designs such as a red crescent on a white field or a red lion and sun on a white field as an indication of a mission of mercy or amnesty from attack.

CHURCH AND JEWISH WORSHIP PENNANTS

With the sole exception of flag displays at United Nations headquarters, where special rules apply, only the church or Jewish pennant may be flown above the national ensign. The church services must be conducted by a Navy chaplain or visiting church dignitaries aboard ship.

Many ships are fitted with two halyards to the same point of hoist at both the staff and gaff to permit display of the church pennant and ensign simultaneously.

In displaying the church pennant, it is hoisted to the peak or truck, the ensign then being dipped just clear of it. If services are being conducted at the time of morning colors, the ensign is hoisted to the truck at the prescribed time. The church pennant is then hoisted and the ensign dipped just clear of the pennant. If the ensign is displayed at half-mast, the church pennant is hoisted just above the ensign. In lowering the church pennant, the ensign is closed up before the pennant is lowered.

Although the church pennant may not be flown above the national flag ashore, it may be displayed separately.

The Jewish worship pennant is displayed during Jewish religious services afloat and ashore. The same rules governing the display of the church pennant apply to the display of the Jewish worship pennant.

POW/MIA FLAG

All activities authorized to fly the national ensign are encouraged to fly the POW/MIA flag on occasions such as Memorial Day, Veterans Day, and National POW/MIA Day.

Ships are to display the flag from the inboard port signal halyard. Ashore display should be beneath the national ensign. The POW/MIA flag can also be used for indoor display to enhance ceremonies.

AWARD FLAGS AND PENNANTS

When not under way, ships should fly award pennants at the foremast from sunrise to sunset, on the same halyard, one below the other, in order of seniority. When ashore, award pennants may be displayed in the order of seniority from the port yardarm at U.S. naval activities. For commands without an appropriate flagpole, a replica of the award flag or pennant may be displayed in or near the vicinity of the command's quarterdeck. When an award flag or pennant is awarded to a department or division within a command, a replica may be displayed in or near the main entrance to that department or division.

ABSENTEE PENNANTS

When a ship is not under way, the absence of an embarked officer, unit commander, chief of staff, chief staff officer, or commanding officer is indicated from sunrise to sunset by an absentee pennant displayed from the signal yardarm as prescribed in the following table. In the case of the absence of the commanding officer who is also a unit commander or acting as a temporary unit commander, both absentee pennants will be displayed.

Signal	Meaning
FIRST SUB—starboard outboard	Absence of a flag officer or unit commander whose personal flag or command pennant is flying on this ship.
SECOND SUB—port inboard	Absence of chief of staff or chief staff officer of the commander whose personal flag is flying on this ship.
THIRD SUB—port outboard	Absence of commanding officer (its use immediately shifts to the executive officer when the commanding officer departs for a period of absence of 72 hours or more).
FOURTH SUB—starboard inboard	Absence of civil or military official whose flag is flying on this ship.



Figure 10-8.—Flags of some leading maritime nations.

NOTE

On a flagship where the commander's personal flag has been hauled down and replaced by a commission pennant, the chief of staff's absentee pennant is not displayed.

FLAGS OF PRINCIPAL MARITIME NATIONS

LEARNING OBJECTIVE: List some of the flags of the principal maritime nations. Figure 10-8 shows flags and ensigns of some principal maritime nations. Unlike the practice in the United States, a number of countries have ensigns different from their national flags.

although color patterns generally remain constant.

SUMMARY

In this chapter you have learned about the basic honors and ceremonies. You have learned of the different rules that govern the display of ensigns and how to determine the appropriate size of ensigns for your ship. You have learned how to challenge small boats at night and the meaning of flagstaff ornaments. You have learned the procedures for returning a dip and which countries are not entitled to a dip. You have learned the rule for the display of personal flags and pennants, the commission pennant, the U.S. Navy flag, the United Nations flag, plus much more.

CHAPTER 11

SECURITY

As a Signalman, you will hear a great deal about the security of classified material. You will have access to and will use classified information every day. For that reason, all activities brief newly arrived Signalmen in security and require them to sign a statement attesting that they have received the briefing and understand the contents. Furthermore, as part of each command's security program, you will be required to read and indicate your understanding of several of the most important national laws and regulations related to security.

Maintaining the security of classified material, however, requires more than a briefing, a regulation, or a law. Security will only be as effective as you make it. There is no one to whom you can transfer your responsibility for protecting this information. Security, along with operating signaling equipment, is a basic part of your duties. You must be security conscious to the point that you automatically exercise proper discretion in the discharge of your duties, and do not think of security as something separate and apart from other matters. In this way, security of classified information becomes a natural element of every task, and not an additionally imposed burden.

PURPOSE OF SECURITY PROGRAM

LEARNING OBJECTIVES: Explain the purpose of the security program. Define command management, security education, and security principles.

The security program deals basically with the safeguarding of information that should not be allowed to fall into the hands of foreign governments, foreign nationals, or other unauthorized persons. The danger being that such information might be used to the detriment of the United States.

Information may be compromised through careless talk, improper handling of classified material, and in various other ways. Some of the ways in which military personnel may accidentally give away vital information are discussed in *Basic Military Requirements*, NAVEDTRA 12043.

COMMAND MANAGEMENT

Commanding officers are responsible for effective management of the Information and Personnel Security Program within their command. Command security management discussion includes the following action areas:

- Designating a security manager
- Designating a Top Secret control officer (TSCO) if Top Secret material is handled by the command
- Designating an ADP security officer if the command processes data or prepares documents in an automated system
- Designating a security officer
- Preparing written command security procedures and an emergency destruction plan for the protection of classified material
- Reviewing and inspecting the effectiveness of the program in subordinate commands

Command Security Manager

Every command in the Navy and Marine Corps eligible to receive classified information is required to designate a security manager in writing. The security manager will be afforded direct access to the commanding officer to ensure effective management of the command's security program.

The security manager may be employed full-time, part-time, or as a collateral duty, but he/she must be an officer or a civilian employee GS- 11 or above. The security manager must be a U.S. citizen and have a favorably completed background investigation (BI).

The security manager is the main advisor on information and personnel security in the command and is responsible to the commanding officer for the management of the program.

The security manager, for effective management of the program, should do the following:

- Develop written command information and personnel security procedures, including an emergency destruction plan.

- Formulate and coordinate the command's security education program.
- Ensure that threats to security, compromises, and other security violations are reported, recorded and, when necessary, investigated.
- Administer the command's program for classification, declassification, and downgrading of classified material.
- Maintain liaison with the public affairs officer to ensure that proposed press releases do not contain classified information.
- Ensure compliance with accounting and control requirements for classified material, including receipt, distribution, inventory, reproduction, and disposition.

The duties of the security manager are numerous. Refer to *Department of the Navy Information and Personnel Security Program Regulation*, OPNAVINST 5510.1, for more information concerning his/her duties.

Top Secret Control Officer

Each command that handles Top Secret information must designate, in writing, a Top Secret control officer (TSCO). The person designated must be an officer, senior non-commissioned officer, or a civilian employee GS-7 or above. The TSCO must be a U.S. citizen with a Top Secret clearance.

The TSCO is responsible to the security manager for the receipt, custody, accounting for, and disposition of Top Secret material in the command. Procedures for the duties of the TSCO are set forth in OPNAVINST 5510.1.

Security Assistant

The security assistant must be a U.S. citizen and either an officer, an enlisted person E-6 or above, or a civilian employee GS-6 or above. The designation must be in writing. The assistant security manager does not require a BI unless he/she has been authorized to issue security clearances. The security assistant assists the security manager in his/her duties.

ADP/Information Systems Security Officer

Each command involved in processing data in an automated system must designate an ADP/IS security officer.

The ADP/IS security officer is responsible to the security manager for the protection of classified information being processed in the automated system and is responsible to the physical security officer for the protection of the personnel, equipment, and related resources.

SECURITY EDUCATION

Each command in the Department of the Navy (DON) that handles classified information will establish and maintain an active security education program to instruct all personnel, regardless of their position, rank, or grade, in security policies and procedures. The overall purpose of the security education program is to make sure that all personnel understand the need to protect classified information and know how to safeguard it.

Commanding officers, through their security managers, are responsible for security education in their commands, and for ensuring it is afforded a significant share of the time dedicated to command security.

SECURITY PRINCIPLES

The Department of Defense (DOD) security formula is based on the premise of circulation control (the control of dissemination of classified information). According to this policy, knowledge or possession of classified defense information is permitted only to persons whose official duties require access to the information (“need to know”).

CLASSIFICATION CATEGORIES

LEARNING OBJECTIVES: Identify and define the classification designations and special markings.

Official information that requires protection in the interests of national security is placed into one of three categories: Top Secret, Secret, or Confidential. Following are examples and definitions of each category.

TOP SECRET

Top Secret is the designation applied only to information that requires the highest degree of protection. It is of such a nature that its unauthorized disclosure could reasonably be expected to cause

exceptionally grave damage to the national security, such as the following:

- An armed attack against the United States or its Allies
- The compromise of military or defense plans, intelligence operations, or scientific or technological developments vital to the national defense
- Disruption of foreign relations vitally affecting the national security

SECRET

Secret is the designation applied only to information the unauthorized disclosure of which could reasonably be expected to cause serious damage to the national security, such as the following:

- Jeopardizing the international relations of the United States
- Endangering the effectiveness of a program or policy of vital importance to the national defense
- Compromising important military or defense plans, or scientific or technological developments important to national security
- Revealing important intelligence operations

CONFIDENTIAL

Confidential is the designation applied only to information the unauthorized disclosure of which could reasonably be expected to cause identifiable damage to the national security, such as the following:

- Information that reveals strength of our land, air, or naval forces in the United States and overseas areas
- Documents and manuals containing technical information used for training, maintenance, and inspection of classified munitions of war
- Research, development, production, and procurement of munitions of war

MARKING

Classified material will be physically marked, annotated, or identified by means as prescribed in this section. The purpose of marking classified material is to inform the holder of the classification level and the degree of protection required, and to assist in extracting, paraphrasing, and downgrading and

declassification actions. Therefore, all classified material must be marked in a manner that leaves no doubt about the level of classification assigned to the material.

Marking Requirements

Marking requirements and the application of the markings vary depending on the kind of material. The following markings are required for all classified material:

Originally classified material

The identity of the original classification authority

The agency or office of origin

Declassification date

The overall classification

Any downgrading instructions

Derivatively classified material

The source of classification

The agency and office of origin

The overall classification

Declassification date

Downgrading actions

Publication Markings

The basic markings will be placed on the front of the publication. The overall classification will be placed at the top and bottom center of the front cover, title page, and first page. Downgrading and declassification instructions appear only on the face of the publication.

A back cover is not required; if used, the overall classification is placed at the top and bottom center.

The classification of each interior page (except blank pages) of a publication will be marked at the top and bottom center of the page. Normally, the overall classification of the publication is used. The marking of each interior page with the highest classification it contains, to include UNCLASSIFIED, is permissible. When marked in this manner, and the page is printed on the front and back, both sides of the page must be marked with the highest classification of either side. When one side contains information of a lower classification than the marking applied, a statement

such as “This page is unclassified” or “This page is Confidential” is used.

When a change is being issued to an existing classified publication, the changed pages will be marked as if they were already entered into the basic publication. If any of the changes is on an interior page, it will be marked in the same way as the interior pages of the basic publication.

Portion Markings

Each section, part, paragraph, or subparagraph of a classified document will be marked to show its level of classification or the fact that it is unclassified. The reason for this requirement is to eliminate any doubt as to which portion of the document contains, or can reveal, information requiring protection. The appropriate symbol will be placed immediately following a portion letter or number, or in the absence of letters or numbers, immediately before the beginning of the portion. The symbols are as follows:

- Top Secret (TS)
- Secret (S)
- Confidential (C)
- For Official Use Only (FOUO)
- Unclassified (U)

In addition to the classification symbols, the following symbols may also be used:

- Restricted Data (S-RD)
- Formerly Restricted Data (S-FRD)
- Critical Nuclear Weapons Design Information (S-RD) (N)

When a major numbered or lettered paragraph and all of its subparagraphs are unclassified, each paragraph need not be marked. Marking the lead-in paragraph with a (U) is sufficient.

The full classification—not the abbreviated form—is marked on figures, tables, graphs, charts, and so forth. The classification marking must be centered just below the illustration. Special situations may dictate the placement of the markings above or actually within the general area of the illustration. The important point is that the reader understand the classification level of that illustration.

COMPROMISES AND SECURITY VIOLATIONS

LEARNING OBJECTIVES: Define *compromises* and *security violations*. List some of the reasons that lead to compromises and security violations.

There are two types of security violations: Those that result in a confirmed compromise or possible compromise of classified information, and those that do not but in which a security regulation has been violated.

Compromise is the disclosure of classified information to a person who is not authorized access. The unauthorized disclosure may have occurred knowingly, willfully, or through negligence.

The compromise of classified information presents a threat to national security. The seriousness of the threat must be determined and action taken to reduce the effects of compromise. At the same time, action must be taken to investigate the circumstances and determine the causes, to prevent recurrence.

Compromise of classified material results when a security violation has resulted in confirmed or suspected exposure of classified information or material to an unauthorized person. The compromise is considered “confirmed” when conclusive evidence exists that classified material was compromised; it is considered “suspected” when some evidence exists that classified material has been subjected to compromise.

Any individual in the DON who is aware of the compromise or possible compromise of classified material must report the facts immediately to the most readily available command.

Individuals who are aware of possible acts of sabotage, espionage, deliberate compromise, or other subversive activities must report immediately all available information to the most readily available command, which, in turn, will notify the appropriate Naval Investigative Service office.

SECURITY CLEARANCES

LEARNING OBJECTIVES: Explain the purpose of security clearances. List and explain the types of BI done on an individual requiring a security clearance.

A personnel security clearance is an administrative determination that an individual is eligible for access to classified information of the same category as or lower than the clearance being granted.

No one will be given access to classified information or be assigned to sensitive duties unless a favorable personnel security determination has been made of his/her loyalty, reliability, and trustworthiness. The initial determination will be based on a personnel security investigation (PSI) appropriate to the access required or to other considerations of the sensitivity of the duties assigned. Only the following personnel are authorized to request PSIs on personnel under their jurisdiction:

- Director, Central Adjudication Facility
- Commanders and commanding officers
- Chiefs of Recruiting stations

Request for PSIs must be kept to the absolute minimum. Reliance on PSIs as a means of identifying problem personnel security cases will be avoided. Special attention is to be given to eliminating unnecessary and duplicate reports. PSIs will not be requested to resolve allegations of a suitability nature for the purpose of supporting personnel administrative decisions or disciplinary procedures independent of a personnel security determination.

The Defense Investigative Service (DIS) or the Office of Personnel Management (OPM) conducts or controls all PSIs for the DON. DON elements are prohibited from conducting PSIs without a specific request from DIS to support its investigative responsibilities.

TYPES OF INVESTIGATIONS

The term *personnel security investigation* describes an inquiry by an investigative agency into an individual's activities for the specific purpose of making a personnel security determination. Investigations conducted for other purposes may have an impact on security clearances or assignments to sensitive duties, but are not PSIs. The following are some of the types of investigations. See *Department of the Navy Information and Personnel Security Program Regulation*, OPNAVINST 5510.1, for more information on PSIs.

National Agency Check

A national agency check (NAC) consists of a check of the files of a number of government agencies for pertinent facts bearing on the loyalty and trustworthiness of the individual. Examples of agencies checked are the FBI and the Defense Central Index of Investigations. The NAC conducted on a first-term enlistee in the Navy or Marine Corps is called an entrance NAC (ENTNAC). The primary reason for the ENTNAC is to determine the suitability of an individual for entry into the service. If a service member reenlists after a break in active service greater than 12 months, an NAC (not an ENTNAC) is requested.

Background Investigation

The background investigation (BI), conducted by DIS, is much more extensive than a NAC. It is designed to develop information as to whether the access to classified information by the person being investigated is clearly consistent with the interests of national security. It includes an NAC and probes deeply into the loyalty, integrity, and reputation of the individual.

Special Background Investigation

The special background investigation (SBI) is an investigation conducted by DIS, with extended coverage of the individual's background to provide a greater depth of knowledge than a BI. The scope of an SBI is 15 years or since the 18th birthday, whichever is shorter. At least 2 years will be covered, except that no investigation is conducted prior to the subject's 16th birthday.

CLEARANCE ELIGIBILITY

Eligibility for a security clearance is limited to members of the executive branch of the U.S. Government or to employees of the DOD contractors, under the Defense Industrial Security Program. Occasionally, it is necessary for the DON to clear persons outside the executive branch of the government. Only U.S. citizens are eligible for security clearances. Non-U.S. citizens may be considered for limited access authorization.

Classified information is made available to appropriately cleared persons only when it is necessary in the interests of national defense and the individual requires the information to carry out

assigned duties. Personnel authorized access to classified information must be trustworthy, loyal, and of good character.

In the following situations, a security clearance is not granted:

- To persons in nonsensitive civilian positions
- To persons whose regular duties do not require authorized access to classified information
 - For ease of movement within a restricted, controlled, or industrial area of persons whose duties do not require access to classified information
 - To persons who may only have inadvertent access to sensitive information or areas, such as guards, emergency service personnel, police, and so forth
 - To persons whose access to classified information can be prevented by a clear escort
 - To maintenance or cleaning personnel who may only have inadvertent access to classified information unless such access cannot be reasonably prevented
 - To persons who perform maintenance on office equipment, computers, typewriters, and similar equipment who can be denied classified access by physical security measures

Reserve personnel in an “active status” are eligible for a security clearance as required. Members of Congress do not require security clearances. They may be granted access to DOD classified information that relates to matters under the jurisdiction of the respective committees.

INTERIM AND FINAL CLEARANCES

Interim clearance may be granted only after the required investigative forms for final clearance have been sent to DIS or OPM and a check of available personnel, medical, legal, security, base police, and other command records do not contain information that clearly indicates that the individual is not a suitable candidate for a position of trust. Interim clearances are effective up to 6 months and may be extended another 6 months if a tracer has confirmed that the investigation is still pending.

A final clearance is granted upon completion of all investigative requirements as set forth in *Department of the Navy Information and Personnel Security Program Regulation*, OPNAVINST 5510.1.

ACCESS

No one has a right to have access to classified information solely because of rank, position, or security clearance. The final responsibility for determining whether a person’s official duties require access to any element or item of classified information and whether he/she has been issued the appropriate security clearance or authorization by proper authority rests with the individual who has the authorized possession, knowledge, or control of the information involved—not with the prospective recipient.

The ultimate authority for granting access to classified information rests with the commanding officer, who is responsible for the security of the information or material in his/her command. A commanding officer may grant access to classified information to an individual who has an official need to know, a valid security clearance or access authorization, and about whom there is no locally available disqualifying information.

More in-depth information concerning access to classified information and material is covered in chapter 24 of OPNAVINST 5510.1.

STORAGE OF CLASSIFIED MATERIAL

LEARNING OBJECTIVES: Explain the procedure for the storage of classified material. Define *security container* and explain requirements when keys and combinations to containers are used.

Commanding officers are responsible for safeguarding all classified information within their commands and for ensuring that classified material not in actual use by appropriately cleared personnel or under their direct personal observation is properly stored.

Any weakness in equipment being used to safeguard classified material in storage is reported to the Chief of Naval Operations. Each report must fully describe the weakness or deficiency and how it was discovered. Reporting is especially important when GSA-approved containers are involved.

Valuables, such as money, jewels, and so forth, will not be stored in the same containers used to safeguard classified material. These items increase the risk that the container will be opened or stolen, with the resulting compromise of the information within.

Table 11-1 identifies the minimum requirement for storing classified material. It must be used in evaluating the security container and supplemental control required to properly safeguard classified information stored within.

STORAGE

Top Secret material will be stowed in a class A or B vault, a strongroom that meets the prescribed standards, or a General Services Administration (GSA) approved security container. When located in a building, structural enclosure, or other areas not under U.S. Government control, the vault, strongroom or security container must be protected by an alarm system or guarded by U.S. citizens during nonoperating hours or located in an alarmed area that affords protection equal to or better than that prescribed. When an alarm is used, the physical barrier must be adequate to prevent the following actions:

- Surreptitious removal of the material
- Observation that would result in compromise of the material

The physical barrier must be such that forcible attacks will result in evidence of attempted entry into the room or area. The alarm system must, at a minimum, provide immediate notice to a U.S. security force of an attempted entry.

Secret and Confidential material will be stored in the manner prescribed for Top Secret material or until phased out; in a steel filing cabinet having a built-in GSA-approved combination lock; or as a last resort, a steel filing cabinet equipped with a steel lockbar, secured by an approved GSA combination padlock. When a lockbar container is used, the following procedures apply:

- The keeper and staples of the lockbar must be secured to the filing cabinet by welding, rivets, or peened bolts.
- The drawers of the container must be held securely closed when the lockbar is in place, so their contents cannot be removed by forcing open a drawer.
- During working hours, padlocks must be placed in the cabinet or locked through the staple until the cabinet is secured at the end of the day.

Table 11-1.—Storage Requirements

	SHORE INSTALLATIONS			SHIPS			AIRCRAFT		
	TS ¹	S	C	TS ¹	S	C	TS ¹	S	C
CLASS "A" VAULT	X	X	X						
CLASS "B" VAULT	X ²	X	X						
STRONGROOM	X ³	X ²	X	X ⁵	X ²	X	X ⁵	X ²	X
GSA CONTAINER	X ²	X	X	X ²	X	X	X ²	X ⁴	X
LOCK BAR CABINET		X ²	X ⁴		X ²	X		X ²	X ⁴
LOCKED CONTAINER OF SUBSTANTIAL METAL OR WOODEN CONSTRUCTION					X ⁶	X ⁶		X ⁶	X ⁶

¹ Must be located in buildings, ships, and aircraft that are under U.S. Government control; otherwise, must be protected by an alarm system or be guarded during non-working hours by U.S. citizens.

² Surrounding area locked and access to area controlled by U.S. personnel.

³ Container alarmed or guarded by U.S. personnel.

⁴ Surrounding area locked.

⁵ Area alarmed and patrolled every hour by U.S. personnel.

⁶ Surrounding area locked when not manned by U.S. personnel. Locked area must be checked every 24 hours.

- Precautionary measures must be taken so papers stored in the container will not protrude from the drawers when they are closed, or cannot be fished out through the cleft surrounding the drawers. One method is the insertion of stiff cardboard, such as a file folder, in a horizontal position above papers filed in the drawer.

Storage areas for bulky Secret or Confidential material must have access openings secured by GSA-approved combination padlocks or key-operated padlocks with high security cylinders. If these storage requirements cannot be met afloat or aboard aircraft, Secret or Confidential material may be stored in a locked container of substantial metal or wood construction secured by an approved GSA combination padlock. In this case, the area must be locked when not manned and checked at least once every 24 hours.

NEW STORAGE CONTAINERS

New security containers should not be procured until a physical security survey of existing equipment and a review of classified records on hand has been made. It might be determined that it would not be feasible to use the equipment or to retire, return, or declassify or destroy a sufficient volume of records currently on hand to make the needed security storage space available.

Only containers that have been approved by the Federal Government as security filing equipment should be procured. Equipment is selected from the National Supply Schedule of the GSA following the procedures outlined in SECNAVINST 10463.1. Modification of any equipment that is used to store classified material is prohibited. Exceptions to permit acquisition of special-purpose equipment or to modify filing cabinets to bar-padlock types suitable for storing classified material must be requested from the CNO.

A security container records form (fig. 11-1) will be maintained for each security container used for the storage of classified material. The container will be inspected each watch.

Security containers conforming to Federal specifications bear a test certification label on the locking drawer, attesting to the security capabilities of the container and lock.

NONAPPROVED SECURITY CONTAINERS

Nonapproved security containers are available in many shapes and sizes; however, containers of this type may not be used to store classified material even though they may be equipped with manipulation-

proof or manipulation-resistant locks and have other security and fire protection features.

Nonapproved containers used to safeguard classified material should be replaced by an approved GSA security container.

COMBINATIONS

A security container, vault, or storeroom must be fitted with a lock that resists opening by unauthorized persons. Manipulation-resistant (MR) and manipulation-proof (MP) locks are tested by the Underwriters' Laboratory (UL) and must have the UL label attached to the back of the lock.

Federal specifications governing the manufacture of security containers and security vault doors require that the unit be equipped with a top-reading changeable combination lock that controls the locking of the container. The top-reading design replaced the front-reading design to provide increased protection against the combination being ascertained by covert viewing. Combination locks are available with two forms of combination changing: hand or key. Hand-changing requires removing the wheel pack and changing the wheel to the new combination. Key-changing requires the use of a key that is inserted into the lock case, permitting a new combination to be set. The type of combination lock desired should be specified when ordering the container.

The following requirements help ensure the effectiveness of combination locks:

1. Combinations must be changed only by individuals having the responsibility and an appropriate security clearance.
2. The combination will be given only to people whose official duties demand access to the container.
3. The combination to a security container is changed at the time the container is received, at the time any person having knowledge of the combination leaves the organization, at any time there is reason to believe that it has been compromised, or as a minimum every 24 months.

In selecting combination numbers, multiples of 5, simple ascending or descending arithmetical series, and personal data (such as birthdates and service numbers) should be avoided. The same combination will not be used for more than one container in any one component.

SECURITY CONTAINER RECORDS FORM			
OPNAV FORM 5510/21 (10-70)		S/N 0107-LF-783-5100	
CONTAINER NUMBER 0284	LOCATION Room 750 CWB	OFFICE CODE CNO (Op-XXX)	TYPE OF CONTAINER (MAKE/SIZE) Mosler/5 drawer legal
DATE RECEIVED (Date)	CLASS OF CONTAINER <input type="checkbox"/> CLASS 2 <input type="checkbox"/> CLASS 3 <input type="checkbox"/> CLASS 4 <input type="checkbox"/> CLASS 5 <input checked="" type="checkbox"/> CLASS 6		FEDERAL STOCK NUMBER 7110-91-9193
SERIAL NUMBER 16155	DATE OF MANUFACTURE (Date)	QUANTITY OF DOCUMENTS 10 linear feet	SCOPE OF MATERIAL Confidential - Secret
SECURITY POINTS FOR CONTAINER		OTHER SECURITY POINTS	TOTAL SECURITY POINTS
PERCENTAGE OF CLASSIFIED MATERIAL STOWED			
TOP SECRET	0%	SECRET	65%
CONFIDENTIAL	35%	UNCLASSIFIED	0%
TYPE OF LOCK (MAKE/MODEL) Mosler Handchange		SERIAL NUMBER (IF APPLICABLE)	
		HASP	LOCK CASE
CONDITION OF CONTAINER Good			
REMARKS See reverse			

FRONT

OPNAV FORM 5510/21 (10-70) (BACK)			
INSPECTION AND REPAIR			
DATE INSPECTED	INSPECTED BY	CONDITION	REPAIRS MADE/DRILLED
(Date)	Rbc	NEW	
(Date)	scw	LOCKOUT	Drawer head replaced (Date)

BACK

86NP0231

Figure 11-1.—Security Container Records form, OPNAV Form 5510/21.

In setting a combination, numbers should be used that are widely separated by dividing the dial into three parts and using a number from each third as one of the combination numbers.

To prevent lockout, two people should try a new combination before closing the container or vault door.

The combination of a vault or container will be assigned a security classification equal to the highest category of the classified material authorized to be stored in it. Records of combinations shall be sealed in an envelope and kept on file by the security manager, duty officer, communications officer, or other persons designated by the commanding officer.

KEYS

When key-operated high-security padlocks are used, keys will be controlled at the level of the highest classification of material being protected. The following safeguards will also be used:

- A key and lock custodian for custody and handling of keys will be appointed.
- A key and lock control register that identifies keys for each lock and where and by whom they are held will be maintained.
- Keys and locks will be audited each month and a written record of each inventory will be made.
- Keys will be inventoried each time custody changes.
- Keys will not be allowed to be removed from the command.

- Keys and spare locks will be stored in a locked security container.

- Locks will be changed or rotated at least annually and replaced if their keys are lost or subjected to compromise.

- Master keying is prohibited.

A record for each vault, secure room, or container used for storing classified material will be maintained showing the location of the container, and the names, home addresses, and telephone numbers of persons having knowledge of the combinations. Standard Form 700 (fig. 11-2) is used for this purpose.

SECURING A SECURITY CONTAINER

When securing a security container, rotate the combination dial at least four complete turns in the same direction. In most locks, if the dials are given only a quick twist, it is possible to open the lock merely by turning the dial back in the opposite direction. Each drawer of the container and file cabinets will be checked to make sure the equipment has been secured.

REPAIRING SECURITY CONTAINERS

Lockouts or repair of any damage that affects the integrity of a security filing cabinet approved for storage of classified material will only be done by appropriately cleared or continuously escorted personnel.

A GSA-approved security file cabinet is considered to have been restored to its original state of security if all damage or altered parts are replaced

CLASSIFICATION		
SECURITY CONTAINER INFORMATION INSTRUCTIONS 1. COMPLETE PART 1 AND PART 2A (ON END OF FLAP). 2. DETACH PART 1 AND ATTACH TO INSIDE OF CONTAINER. 3. MARK PARTS 2 AND 2A WITH THE HIGHEST CLASSIFICATION STORED IN THIS CONTAINER. 4. DETACH PART 1 AND INSULT 1 IN ENVELOPE. 5. SEE PRIVACY ACT STATEMENT ON REVERSE.		
1. ARFA OR POST (if required)	2. BUILDING (if required) WOLF	3. ROOM NO. 363
4. ACTIVITY (DIVISION, BRANCH, SECTION OR OFFICE) NAIC-21	5. CONTAINER NO. 13	
6. MFG & TYPE TRT Metal	7. MFG & TYPE LOCK S & G	8. DATE COMBINATION CHANGED -3 SEP 87
9. NAME AND SIGNATURE OF PERSON MAKING CHANGE John Doe		
10. Immediately notify one of the following persons, if this container is found open and unattended.		
EMPLOYEE NAME	HOME ADDRESS	HOME PHONE
JOHN DOE	8623 Georgia Ave, Silver Spring	(301) 427-5969
B. JOE SMITH	1222 Oak Hill Rd. Olney	(301) 555-1234
1. ATTACH TO INSIDE OF CONTAINER		
700-101 NSN 7540 01 214 5372 STANDARD FORM 700 (8-85) Prescribed by GSA/1500 32 CFR 2003		
CLASSIFICATION		

CLASSIFICATION	
CONTAINER NUMBER 13	
COMBINATION	
4	turns to the (Right) (Left) stop at 28
3	turns to the (Right) (Left) stop at 77
2	turns to the (Right) (Left) stop at 46
1	turns to the (Right) (Left) stop at 0
WARNING	
THIS COPY CONTAINS CLASSIFIED INFORMATION WHEN COMBINATION IS ENTERED	
UNCLASSIFIED UPON CHANGE OF COMBINATION	
2A	INSERT IN ENVELOPE
CLASSIFICATION	
SF 700 (8-85) Prescribed by GSA/1500 32 CFR 2003	

Figure 11-2.—Security Container Information form, Standard Form 700.

with new cannibalized parts. A container that has been drilled immediately adjacent to or through the dial ring to neutralize a lockout should be restored in the following manner: The replacement lock is equal to the original equipment; the drilled hole is repaired with a tapered case-hardened steel rod with a diameter slightly larger than the hole. The outside of the drawer must be puttied, sanded, and repainted so no visible evidence of the hole or its repair is noticeable.

SAFEGUARDING

LEARNING OBJECTIVES: Explain the procedures for safeguarding classified information. Explain restricted area, the care of working spaces, the care to be taken during working hours, and security checks to help safeguard classified information.

Classified information or material will be used only where there are facilities, or under conditions, adequate to prevent unauthorized persons from gaining access to it. Where possible, classified holdings will be consolidated to limit the area where they will be used.

Anyone who has possession of classified material is responsible for safeguarding it at all times, and particularly for locking classified material in appropriate security equipment whenever it is not in use or under supervision of authorized persons. The custodian must follow procedures that ensure unauthorized persons do not gain access to classified information by sight or sound or other means. Classified information will not be discussed with or in front of unauthorized persons.

A custodian will not remove classified information or material from designated office or working areas except in the performance of his/her official duties and under conditions providing the protection required by OPNAVINST 5510.1.

Under no circumstance is a custodian to remove classified material from designated areas for the purpose of working on such material during off-duty hours or for other purposes involving personal convenience unless specifically approved by the Chief of Naval Operations, a fleet commander in chief, the commander of the Naval Space Command, the commanders of the Naval System Commands, the Chief of Naval Research, the Commandant of the Marine Corps, or the Commanding General of Fleet

Marine Force Atlantic or Pacific. Approval will be given only when there is an overriding need; when the required physical safeguards, including a GSA-approved container, are met; and when a list of all the material removed is kept at the command.

RESTRICTED AREAS

Depending on the nature of the work, information, equipment, and material concerned, different areas within a command may have varying degrees of security. To meet this situation, the command should apply different protective measures.

To provide for an effective and efficient method to restrict access and to control movement where classified material is stored or used, such areas will be designated Restricted Areas and only those persons whose duties actually require access and who have appropriate security clearances will be allowed freedom to move within the area. Persons not having the proper clearances may, with appropriate approval, be admitted into an area, but they must be controlled by an escort.

Restricted Area warning signs will be posted at all normal points. When a language other than English is prevalent, warning signs will be in both English and the local language.

CARE DURING WORKING HOURS

During working hours, precautions should be taken to prevent access to classified information by unauthorized personnel. Among the necessary precautions to be followed are the following:

- When classified documents are removed from storage for working purposes, they are to be kept under constant surveillance, face down or covered when not in use. Cover sheets will be Standard Forms 703, 704, or 705 respectively, for Top Secret, Secret, and Confidential documents.

- Classified information will be discussed only when unauthorized persons cannot overhear the discussion. Particular care should be taken when there are visitors or workmen present. Escorts should alert fellow workers when visitors or workmen enter the space.

- Drafts, carbon sheets, carbon paper, typewriter ribbons (one-time), plates, stencils, stenographic notes, worksheets, and similar items containing classified information are either destroyed by the person responsible for the preparation of material after they

have served their purposes, or are given the same classification and safeguarded in the same manner as the classified material produced with them.

- New typewriter ribbons used in the preparation of classified material are either typed on until illegible or given the same classification and safeguarded in the same manner as the classified material prepared with them.

- Personnel will not normally be permitted to work alone in areas where Top Secret information or information controlled under special access program procedures is used or stored and is accessible to those employees. This policy, the two person integrity requirement, does not apply in those situations where one individual is left alone for a brief period during normal duty hours. It does not require both individuals to have equal access or that a "no lone zone" be established around Top Secret areas, nor is the requirement as stringent as the two-person control requirement for the Communication Material System

(CMS). Outside normal duty hours, strict adherence to two-person integrity will be followed.

SECURITY CHECKS

Commanding officers must require a security check at the end of each working day to ensure that all classified material is properly secured, and that Standard Forms 701 and 702 (figs. 11-3 and 11-4) are used. The security check determines the following:

- All classified material is stored in the manner prescribed.
- Burn bags are properly stored or destroyed.
- The contents of wastebaskets that contain classified material have been properly stored or destroyed.
- Classified shorthand notes, carbon paper, carbon and plastic typewriter ribbons, rough drafts, and similar papers have been properly stored or destroyed.

ACTIVITY SECURITY CHECKLIST		DIVE/OWBRAMQ/OFFICE <i>NSIC 21</i>										ROOM NUMBER <i>363</i>			MONTH AND YEAR <i>JAN 88</i>																	
Irregularities discovered will be promptly reported to the designated Security Office for corrective action.		Statement I have conducted a security inspection of this work area and checked all the items listed below.																														
TO (if required)					FROM (if required)										THROUGH (if required)																	
ITEM	1	2	3	4	5	6	7	8	9	10	11	12	13	14	15	16	17	18	19	20	21	22	23	24	25	26	27	28	29	30	31	
1. Security containers have been locked checked.	✓	✓	✓	✓	✓																											
2. Desks, wastebaskets and other surfaces and receptacles are free of classified material.	✓	✓	✓	✓	✓																											
3. Windows and doors have been locked (where appropriate).	✓	✓	✓	✓	✓																											
4. Typewriter ribbons and AMP discs (i. e., disks, tapes) containing classified material have been removed and properly stored.	✓	✓	✓	✓	✓																											
5. Security alarm(s) and equipment have been activated (where appropriate).	✓	✓	✓	✓	✓																											
INITIAL FOR DAILY REPORT	<i>MBMBMBMB</i>																															
TIME	<i>11:00 / 7:00 AM / 7:00</i>																															

Figure 11-3.—Activity Security Checklist, Standard Form 701.

behind pictures and radiators, and under desks. Repairs, routine maintenance, and cleaning in sensitive areas should be performed by reliable personnel under supervision.

DECLASSIFICATION, DOWNGRADING, AND UPGRADING

LEARNING OBJECTIVE: Explain the procedures for declassification, downgrading, and upgrading of classified information.

DECLASSIFICATION/DOWNGRADING

Information classified by the DON will be declassified as soon as national security considerations permit. Declassification or downgrading must be based on the loss of sensitivity of the information with the passage of time or the occurrence of an event that permits declassification or downgrading.

The following officials are authorized to declassify or downgrade classified information:

- Secretary of the Navy
- The original classification authority, his/her successor, or a superior of either
- The deputies or chief of staff to those original classification authorities for classified information within their functional areas
- The director of Navy history and the director of Marine Corps history and museums, in coordination with original classification authorities, for historical records in their custody

The above mentioned officials are the only ones who can decide that certain information no longer requires the protection originally assigned. The authority to declassify or downgrade is not to be confused with the administrative responsibility of a holder of classified information to declassify or downgrade it as directed by a classification guide, the continued protection guidelines, or the instruction on a document.

TRANSFERRED MATERIAL

When classified material is officially transferred from one command to another, the receiving commanding officer, if he/she is a designated authority, becomes the declassification and

downgrading authority over the material. If the commanding officer is not designated, the next senior official in his/her command will be responsible for declassification and downgrading.

When practicable, material will be reviewed for declassification or downgrading before it is sent to records centers or to the national archives for storage.

UPGRADING

Authorities may upgrade classified information within their functional areas only when:

- all known holders of the information can be promptly notified; and
- all known holders of the information are authorized access to the higher level of classification, or the information can be retrieved from the known holders not authorized access to the higher level of classification.

Information previously determined to be unclassified may be classified only when the original classification authority determines that correct criteria has been met, that control of the information has not been lost, and that loss of control can still be prevented.

If classified information is, through administrative or other error, disseminated as unclassified or is underclassified, every effort will be made to retrieve, safeguard, and properly mark and control the information.

NOTIFICATION

Notices are not issued to declassify or downgrade material marked with specific events for declassification or downgrading. All original addressees will be notified, however, of an unscheduled change to shorten or lengthen duration of or to change the classification level. A notice assigning classification to currently unclassified information will be classified Confidential unless the notice itself contains information at a higher level. The notice declassification date will be no less than 90 days from the date of the notice.

ACCOUNTING AND CONTROL

LEARNING OBJECTIVE: Explain the procedures for the accounting and control of Top Secret, Secret, and Confidential material.

The accounting system for an activity should provide readily available information on what classified material it has received, what classified material it has produced, and who has custody of the material.

The control of classified material is necessary for several purposes. It must be controlled (1) to limit dissemination and to prevent excessive production or reproduction; (2) so that when the material is regraded or declassified, the holder or recipients can be determined and notified; and (3) so that the office or person normally responsible for its security can be determined.

Top Secret Material

The command TSCO is responsible for receiving, maintaining, distributing, and destroying Top Secret documents. All Top Secret material received by a command will be entered into the command's accountability register. This register will identify each Top Secret document, including the changes, show the number of copies, and give the disposition of each copy. The register will be retained for 5 years after the documents are transferred, downgraded, or destroyed.

All Top Secret documents and equipment will be serially numbered at the time of origination. Additionally, each document will be marked to indicate its copy number as follows:

Copy No. ____ of ____ copies

Top Secret documents must contain a list of effective pages and include a record of page checks. When that is impracticable, as in correspondence or messages, the pages shall be numbered as follows:

Page ____ of ____ pages

Retention of Top Secret documents will be kept to a minimum. Nonrecord documents will be destroyed as soon as their intended purpose has been served. When Top Secret documents are destroyed, a record of destruction will be prepared identifying the material destroyed and the two officials who witnessed the destruction. Top Secret documents that cannot be destroyed will be reevaluated and, when appropriate, downgraded, declassified, or retired to designated records centers.

Top Secret material may not be reproduced without the permission of the issuing office or higher authority; and when copies are made, each will be annotated to show its copy number.

A disclosure record, which shows the document title, the names of all individuals who have been afforded access to the document, and the date of access, must be maintained for each Top Secret document. Those in the command who may have access to containers in which Top Secret information is stored or who regularly handle large volumes of Top Secret information need not be included in the disclosure records. Disclosure records will be maintained for 5 years after the information has been downgraded, the document has been destroyed, or custody has been transferred.

The control of Top Secret information is maintained by the TSCO, if one is designated, or the classified material control officer. You may be required to assist either of them.

Secret Material

As a minimum requirement, commands must establish administrative procedures for recording all Secret material originated by, received and distributed or routed to components of or activities within the command, or disposed of by the command by transfer of custody or destruction. Records will be retained for at least 2 years.

Confidential Material

There is no requirement to maintain records of receipt, distribution, or disposition of Confidential material. Administrative provisions are required, however, to protect Confidential information from unauthorized disclosure by access control and by compliance with the regulations on marking, storage, transmission, and destruction.

DISPOSITION OF CLASSIFIED MATERIAL

LEARNING OBJECTIVE: List procedures for the disposition of classified material when an individual is separated, dies, deserts, is relieved, or is missing in action.

When military or civilian personnel are separated from the DON, all classified material held by them is turned in to the source from which it was received, to their commanding officer, or to the nearest naval command, as appropriate, prior to delivery of final orders or separation papers.

A person about to be relieved will deliver to his/her successor all classified material in his/her custody. Appropriate receipts will be completed covering the change of custody for all Top Secret material. Classified material required by an individual at his/her next duty station, when approved, may be officially transferred.

When an individual dies, deserts, or is declared missing in action, the commanding officer, in disposing of the personal effects, makes sure no classified material is contained in the effects. Every effort will be made to recover classified material known to have been in possession of the person. Material not recovered or not known to be destroyed will be reported as a possible compromise.

DISSEMINATION

LEARNING OBJECTIVE: List procedures for the dissemination of classified material.

Commanding officers establish procedures for the dissemination of classified information originated or received by their command to limit outside dissemination to those activities having a need to know and to reflect any restriction imposed by originators or higher authority. Commanding officers also ensure that material prepared or submitted for public release does not contain classified information or proscribed technical data.

Except where specifically permitted, classified material originating in a non-DOD department or agency will not be disseminated outside the DOD without consent of the originating department or agency.

TOP SECRET

Top Secret material originated within the DOD will not be disseminated outside the DOD without consent of the originating department or agency, or higher authority.

SECRET AND CONFIDENTIAL MATERIAL

Secret or Confidential material originated within the DOD may be disseminated to other departments and agencies of the executive branch of the government unless specifically prohibited by the originator.

DISTRIBUTION

The distribution of classified material must be limited to those persons whose official duties require them to have knowledge or possession of such material. Responsibility for determining whether a person's duties require access to classified information and that the person is authorized to receive it rests upon each individual who has possession, knowledge, or control of the information involved.

The existence, nature, content, or whereabouts of classified information must not be divulged needlessly.

Classified material may be distributed to all agencies of the executive branch of the government. On requests from DOD agencies, the "need-to-know" may be judged on the face of the request. When the "need-to-know" is not discernible from the scope of the requester's activities, the need must be determined. Classified material sent to other activities of the executive branch of the government must be sent via the departmental headquarters of the requesting activity for a determination of "need-to-know" and capability to handle classified material.

No person in the DON is to convey orally, visually, or by written communication any classified information outside the executive branch of the government of the United States unless such disclosure has been specifically authorized by the CNO.

Classified information must not be discussed over telephones because of insecurity resulting from executive cut-in, phantom voice interceptions, and wiretapping. Telephones located in sensitive areas must be provided with a means of complete disconnection, such as a plug or jack arrangement if they are considered safe. Intercom systems located in sensitive areas must be confined to the sensitive area.

DESTRUCTION OF CLASSIFIED MATERIAL

LEARNING OBJECTIVE: Explain the procedures for the destruction and emergency destruction of classified material.

Top Secret, Secret, and Confidential material may be destroyed by burning, pulping, pulverizing, or

shredding, provided the destruction is complete and reconstruction is impossible. The destruction of Top Secret and Secret material will be recorded. Destruction may be recorded on OPNAV Form 5511/12 or on any other record that includes complete identification of the material, the number of copies destroyed, and the date of destruction. Destruction must be witnessed by personnel having a security clearance at least as high as the category of material being destroyed, and those witnesses must be thoroughly familiar with regulations and procedures for safeguarding classified information. Two officials will be responsible for the destruction of Top Secret and Secret material and will sign the record of destruction. Records of destruction will be retained for a period of 2 years.

When Top Secret or Secret material is placed in a burn bag, the witnessing official signs the record when the material is actually placed in the burn bag. Burn bags containing classified material must be safeguarded according to the classification of the material therein. When the burn bags are destroyed, the destruction must be witnessed by two appropriately cleared personnel. The persons accomplishing the actual destruction need not sign the record of destruction, but it would be appropriate to require a signature for the number of burn bags destroyed. All burn bags will be serially numbered, and a record will be kept of all handling until destroyed. The two persons actually doing the destroying will sign the record of handling. The record of handling will be retained for 2 years.

Confidential material and classified waste are destroyed by authorized means by appropriately cleared personnel, but these materials do not require a record of destruction.

Assignment to the destruction detail will be rotated periodically. Both personnel will be cleared to the highest level of information being destroyed. They must be familiar with the regulations and procedures for safeguarding classified information.

EMERGENCY DESTRUCTION

Commands located outside the United States and its territories, all deployable commands, and all commands holding COMSEC material must include in their emergency plan the destruction of classified material. Emergency destruction plans must be practical and reasonable and take into account the following factors:

- The level and sensitivity of classified material held by the activity
- The proximity of land-based commands to hostile or potentially hostile forces
- Flight schedules or ship deployments in the proximity of hostile or potentially hostile forces or potentially hostile environments
- The sensitivity of operation assignment (contingency planning should also be considered)
- The size and armament of land-based commands and ships
- The potential for aggressive action of hostile forces

Effective emergency planning includes the following measures:

- Reducing the amount of classified material held to the absolute minimum.
- Storing less frequently used classified material at more secure commands.
- To the extent possible, transferring retained material to magnetic media, which is more easily destroyed than paper. This precaution will also reduce the bulk that needs to be evacuated or destroyed.

The emergency destruction plan will emphasize the procedures and methods of destruction. It will clearly identify the exact location of all classified material. The plan will include priorities for destruction, billet designations of personnel responsible for destruction, and the prescribed place and method of destruction.

The emergency destruction plan will authorize the senior individual present in a space to deviate from established plans when situations warrant. It will also identify the individual who is authorized to make the determination as to when emergency destruction is to begin and the means by which this determination is to be communicated to all subordinate elements maintaining classified information.

Emergency destruction drills will be conducted at least annually to ensure that personnel concerned are familiar with the plan and associated equipment. Records of drills will be maintained for 2 years.

Emergency destruction falls into three priority classes: priority one, two, and three. These priorities will be based on the potential effect on national

security should holdings fall into hostile hands. The priorities are as follows:

Priority One—Top Secret material

Priority Two—Secret material

Priority Three—Confidential material

The requirement for priority-one material is that it must be destroyed first, with a time objective as follows:

Shore stations—60 minutes

Afloat stations—30 minutes

Aircraft—3 minutes

METHODS OF EMERGENCY DESTRUCTION

Classified material may be jettisoned at sea at depths of 1,000 fathoms or more. If such water depth is not available and if time does not permit other means of emergency destruction, the material should, nonetheless, be jettisoned to prevent its easy capture. When shipboard emergency destruction plans include jettisoning, document sinking bags shall be available. If a vessel is to be sunk through intentional scuttling or is sinking due to hostile action, classified material should be locked in security filing cabinets or vaults and allowed to sink with the vessel rather than attempting jettisoning.

Other means of emergency destruction include dismantling or smashing metallic items beyond reconstruction by available means such as sledge hammers, cutting tools, and torches; and supplementing emergency destruction devices with routine destruction equipment when time and circumstances permit. As a last resort and where none of the methods previously mentioned can be employed, use other means, such as dousing the classified material with a flammable liquid and igniting it; for instance, throwing all your classified material in the flagbag and igniting it.

REPORTING EMERGENCY DESTRUCTION

Accurate information concerning the extent of emergency destruction of classified material is second in importance only to the destruction of the material itself. Accordingly, the facts surrounding the destruction shall be reported to the CNO and other interested commands by the most expeditious means available. Reports are to contain the following information:

- Identification of the items of classified material that may not have been destroyed
- Information concerning classified material that may be presumed to have been captured
- Identification of all classified material destroyed and the methods of destruction

Additionally, within 6 months after the destruction, a written statement describing the character of the records and showing when and where the destruction was accomplished will be submitted to the Commander, Naval Data Automation Command.

The requirement for reporting of the emergency destruction of classified material shall be included as a part of the command's emergency plan.

SUMMARY

In this chapter, you learned the importance of security. You learned the purpose of the security program and the different classification categories. You learned what a compromise is and how to obtain a security clearance. You learned about the storage of classified material and the custodial precautions. You also learned how to destroy classified material and the procedures for reporting destructions. Security is a major part in running an effective signalbridge. So take a little time and learn your security!

CHAPTER 12

AMPHIBIOUS DUTIES

A special amphibious signal system for ship-to-shore movements is used when amphibious landings are conducted. Panels, shapes, flags, and lights are used for this system. Do not confuse these signals with any of those in ATP 1, volume II, or the *International Code of Signals*. Review the amphibious signal system instructions in NWP 22-3, *Ship-to-Shore Movement*, for complete details on all amphibious signals and instructions. This chapter covers just the basics that you, as a Signaller, need to know for an amphibious landing.

AMPHIBIOUS OPERATIONS

LEARNING OBJECTIVE: Explain the general concept of an amphibious operation ship-to-shore movement.

The ship-to-shore movement is the portion of the assault phase of an amphibious operation that includes the deployment of the landing forces from assault shipping to designated areas. Its object is to ensure the landing of troops, equipment, and supplies at prescribed times and places and in the formation required by the landing force scheme of maneuver for operation ashore. Ship-to-shore movement may be executed by water, air, or a combination of both. It commences at the order of the Commander, Amphibious Task Force (CATF), and concludes when the unloading of all assault shipping is completed.

AMPHIBIOUS SHIPS AND CRAFTS

LEARNING OBJECTIVES: Identify and explain the duties of ships and landing crafts involved in an amphibious operation.

The following ships and landing craft are vital to carrying out the operation of an amphibious assault.

COMMAND SHIP (LCC)

The amphibious command ship serves as a command ship for the amphibious task force (ATF), landing force, and tactical air commanders during an

amphibious assault. It also provides facilities for a joint communications center, supporting arms coordinating center, and central control of both the waterborne and helicopterborne ship-to-shore movement. The LCC may also provide facilities for the task force medical regulating center, but has limited medical facilities and is unsuitable as a major casualty receiving and treatment station.

GENERAL-PURPOSE ASSAULT SHIP (LHA)

The LHA combines many of the operational capabilities of other amphibious ships. It has helicopter operating facilities greater than those of an assault ship (LPH), and has well deck capacity twice the size of a transport dock (LPD). The LHA is also capable of carrying the landing craft, air cushion (LCAC) in the well deck. The LHA also provides facilities for Navy and Marine command and control, including a helicopter direction center and a medical regulating control officer. When augmented with appropriate personnel, LHAs serve as primary casualty receiving and treatment ships and provide triage functions and early definitive medical and surgical care for combat casualties.

MULTIPURPOSE ASSAULT SHIP (LHD)

The LHD is the largest class amphibious ship in service. It has improved capabilities over the LHA, in particular; the LHD is able to operate conventional landing craft, LCAC, fixed-wing tilt-rotor aircraft, and helicopters.

TRANSPORT DOCK (LPD)

The LPD transports and lands troops and their equipment and supplies by means of landing craft, amphibious vehicles, and helicopter. An LPD can function as a primary control ship (PCS) for waterborne crafts, but it has limited boat haven, helicopter storage, and control facilities. Some ships of this type are configured with Navy and Marine command and control facilities. The LPD has less extensive medical facilities than the LPH/LHA, but

would be suitable for use as a secondary casualty receiving and treatment ship.

ASSAULT SHIP (LPH)

The LPH is the principal ship employed to support vertical assault (helicopterborne) ship-to-shore movement. It embarks, transports, and lands troops and their equipment and supplies. It may land the personnel and equipment by embarked transport helicopters or, under unusual circumstances, by landing craft provided by other ships. The LPH also provides facilities for Navy and Marine command and control, including a helicopter direction center, and a medical regulating control officer. When appropriate personnel are on board, the LPH serves as a primary casualty receiving and treatment ship and provides triage functions and early definitive medical and surgical care.

LANDING SHIP (LSD)

The LSD transports and lands amphibious vehicles or landing craft and their accompanying troops and equipment. It is capable of repairing landing craft and may also be used as a helicopter landing platform, a PCS for waterborne craft, and a boat haven. The LSD has limited medical facilities, and is not suitable for service as a casualty receiving and treatment ship.

LANDING CRAFT

The types of landing craft used to land assault troops, their equipment, and supplies are as follows:

- LANDING CRAFT PERSONNEL LARGE (LCPL)—The LCPL is used to support UDT operations, as a gig/officer boat, and as a general

utility boat. Although not normally used for troops/cargo, it is capable of transporting 17 troops or 3,000 pounds of cargo. In amphibious operations, it is used for control/safety purposes within the boat group or as the LVT safety boat.

- LANDING VEHICLE TRACKED (LVT)—The LVT operates on both land and water and can negotiate obstacles that prevent other landing craft from beaching. Primarily used as a personnel carrier, it may also be used later in offshore personnel transfer. In addition, the LVT is an important vehicle for logistic support, since cargo may be carried directly from the ship to an inland beach dump.
- LANDING CRAFT UTILITY (LCU)—The LCU is made of steel with cargo space measuring 100— feet long by 18— feet wide and 4.5— feet deep, for a carrying capacity of 400 tons. See figure 12-1.
- LANDING CRAFT MECHANIZED—There are two types of LCMs: LCM 6 and LCM 8. The LCM 6 can carry 34 tons of cargo, 80 combat-equipped troops, or a 36-ton tank. The LCM 8 steel hull can carry up to 65 tons, 200 combat-equipped troops, or a 60-ton tank. The LCM is shown here in figure 12-2.
- LANDING CRAFT, AIR CUSHION (LCAC)—The LCAC is a fully amphibious, air-cushion vehicle capable of operating from an existing well deck ship. Its mission is to transport weapons systems, equipment, cargo, and personnel of the assault elements of the Marine Air/Ground Task Force both from ship-to-shore and across the beach. Figure 12-3 is a picture of an LCAC.

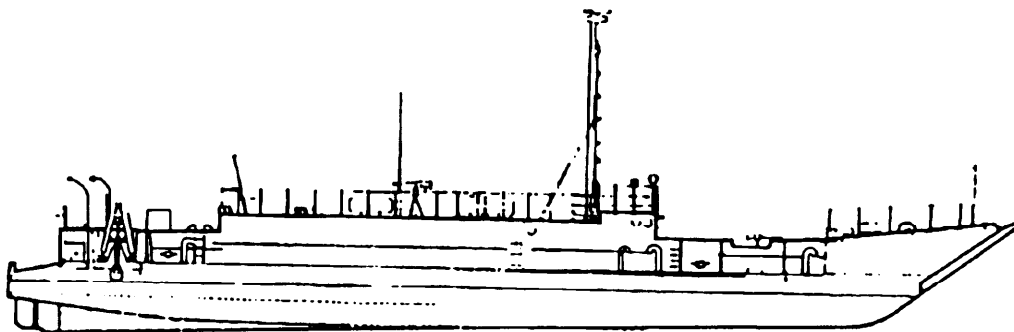

LANDING CRAFT UTILITY (ASSAULT), LCU 1610, 1626, AND 1646 CLASS

73NP0078

Figure 12-1.—Landing craft utility (LCU).

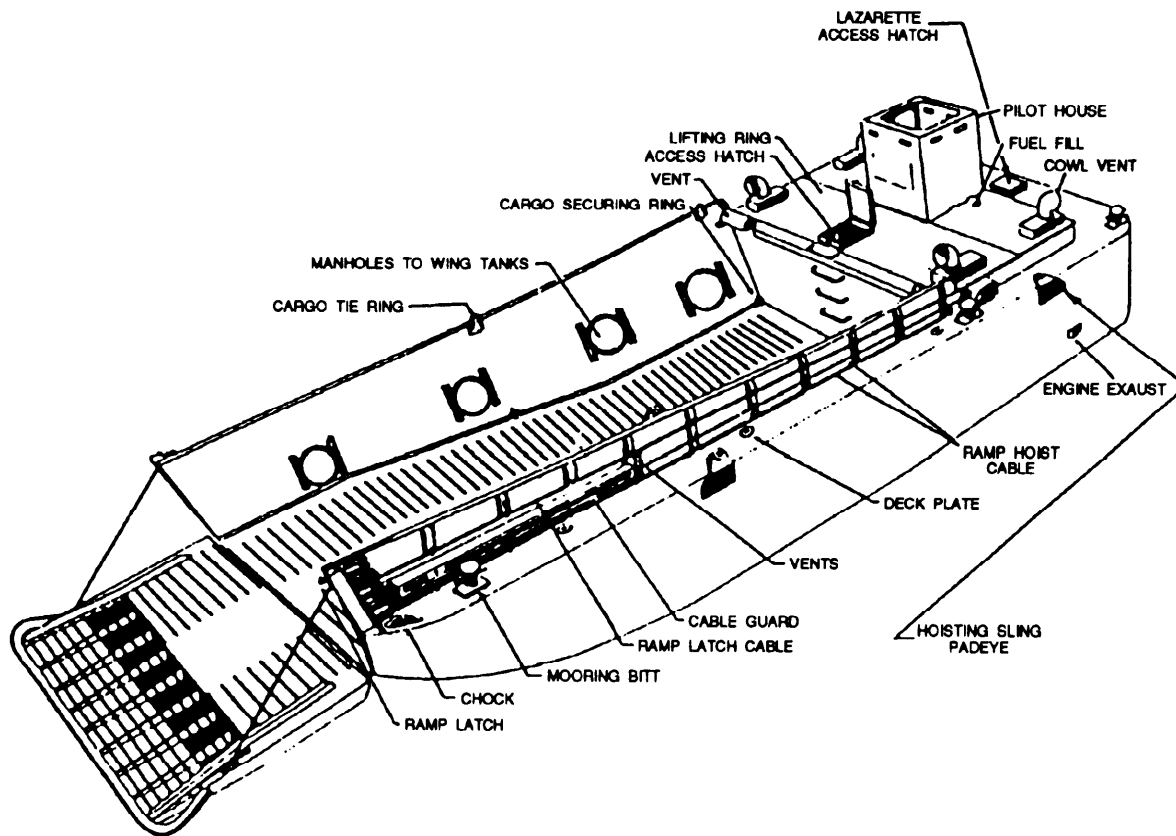

Figure 12-2.—Landing craft mechanized (LCM).

73NP0079

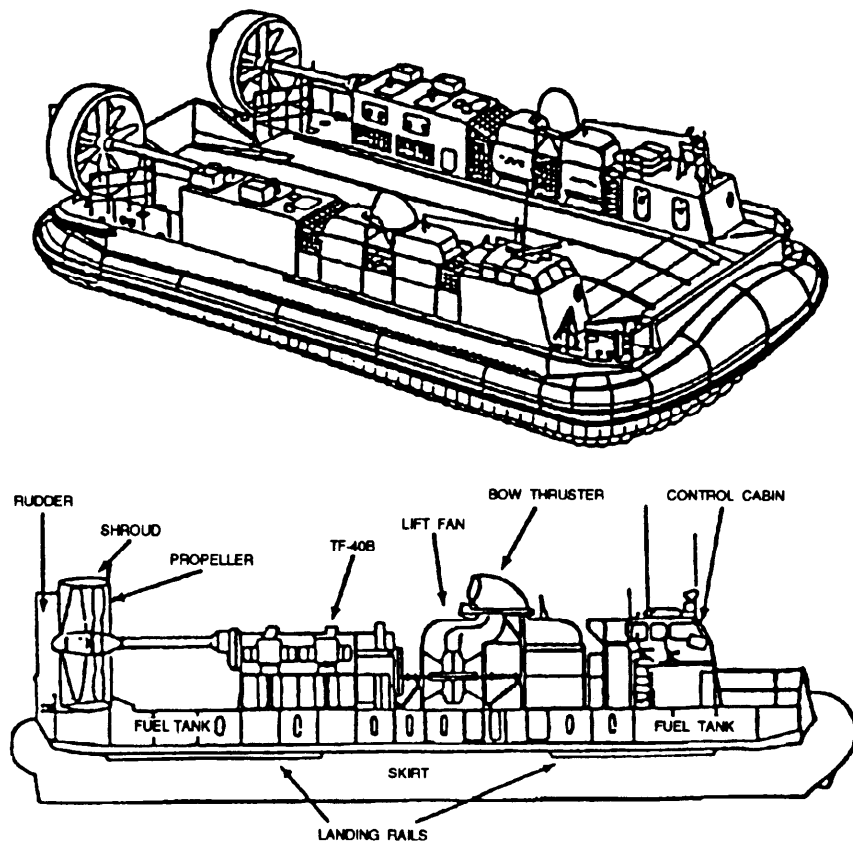

Figure 12-3.—Landing craft, air cushion (LCAC).

73NP0080

These craft are capable of beaching where conditions permit and, with the exception of the LCPL, are provided with bow ramps for discharging personnel and equipment directly on the beach. Landing craft are usually preloaded and lifted to the objective area in the well of LHAs, LHDs, LSDs, and LPDs.

WATERBORNE SHIP-TO-SHORE MOVEMENT

LEARNING OBJECTIVES: Explain the procedures for conducting a ship-to-shore waterborne movement, including the sequence of operation, preparation, and execution.

Waterborne ship-to-shore movements are conducted in the following sequence:

1. Assembly and formation of landing ships, amphibious vehicles, and landing craft in the transport area.
2. Debarkation of troops and equipment from assault shipping into the landing craft and amphibious vehicles.
3. Transfer line operations, when required.
4. Landing of assault, combat support, combat service support, and reserve troops and their supplies.

When underway launch of amphibious vehicles and/or preloading landing craft is used, the ship-to-shore movement is modified. The sequence begins with the underway launch of the troops and equipment from assault shipping by amphibious vehicles or landing craft, and then continues as just listed.

FINAL PREPARATION

As the ATF starts the final approach to assigned positions for the assault, ships prepare for the debarkation of embarked troops, equipment, and supplies according to previously prepared plans. The beginning of debarkation and the timing of the ship-to-shore movement depends on the designated H-hour. All elements must be prepared to modify timing on short notice to conform with changes to H-hour.

SHIPS AND ELEMENTS POSITIONING

To ensure that H-hour will be met, all elements of the ATF arrive on station sufficiently in advance of H-hour to permit preliminary operations between the time the signal "Land the landing force" is made and H-hour. The time required depends upon a number of things, such as the need for pre-H-hour transfers, the nature of loading, and the number of scheduled waves.

EXECUTION

Prior to the arrival of the assault elements in the transport area, the decision will have been made to execute either the primary assault plan or one of the alternate plans. The amphibious task force commander initiates the landing with the landing force signal. When the signal has been made, ships that are debarking troops or material in the scheduled waves will take the actions that are necessary to meet the prescribed H-hour, and boats and craft that are being discharged proceed to the assembly area. After being advised on the progress of debarkation and consulting with the landing force commander, the amphibious task force commander will either confirm or modify H-hour.

DEBARKATION

LEARNING OBJECTIVES: Explain debarkation, debarkation areas, and control areas. List the day and night procedures for calling boats alongside and into the well deck area.

Designated debarkation stations are used for off-loading troops into boats alongside. Debarkation nets for debarking over the side of the ship are used by all troops to be landed in boats except those accompanying equipment preloaded in craft. The following paragraphs pertain to the debarkation process.

DEBARKATION AREAS

Landing craft or boats are placed in assembly circles, wave-forming circles, or rendezvous areas (fig. 12-4) prior to dispatching them for their duty.

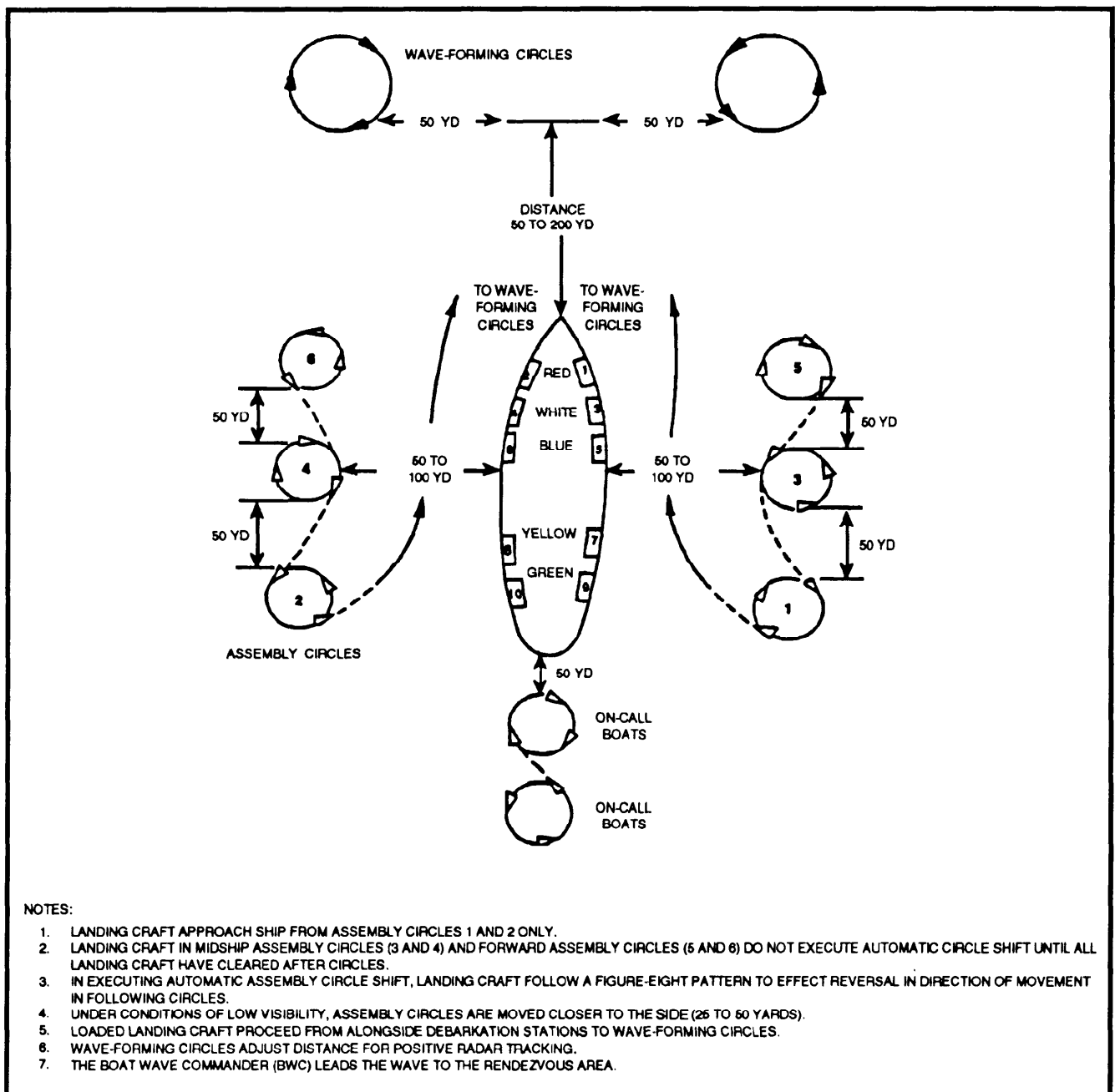

73MP0081

Figure 12-4.—Landing craft assembly circles.

Assembly Areas

Assembly circles are located on each bow, beam, and quarter of the transport, as appropriate. On-call circles are located astern of the transport. Boats will only approach when called from the aft circle. Boats in midships and boats in the forward circle cannot shift until all boats have cleared the aft circle.

Wave-Forming Circles

Wave-forming circles are located close to the bow of the parent vessel to facilitate the assembly

of a wave after loading. The wave-forming circles provide CIC with the opportunity to better identify and control the wave.

Landing Craft Rendezvous Area

The rendezvous area is designated for assembling loaded landing craft by waves prior to dispatching them along the designated approach lane to the line of departure (LOD).

CONTROL AREAS

Line of Departure (LOD)

The assault wave control areas (fig. 12-5) of an amphibious assault are discussed in the following paragraphs.

The LOD is a designated line offshore approximately parallel to the landing beach. From this line the successive assault waves are dispatched for

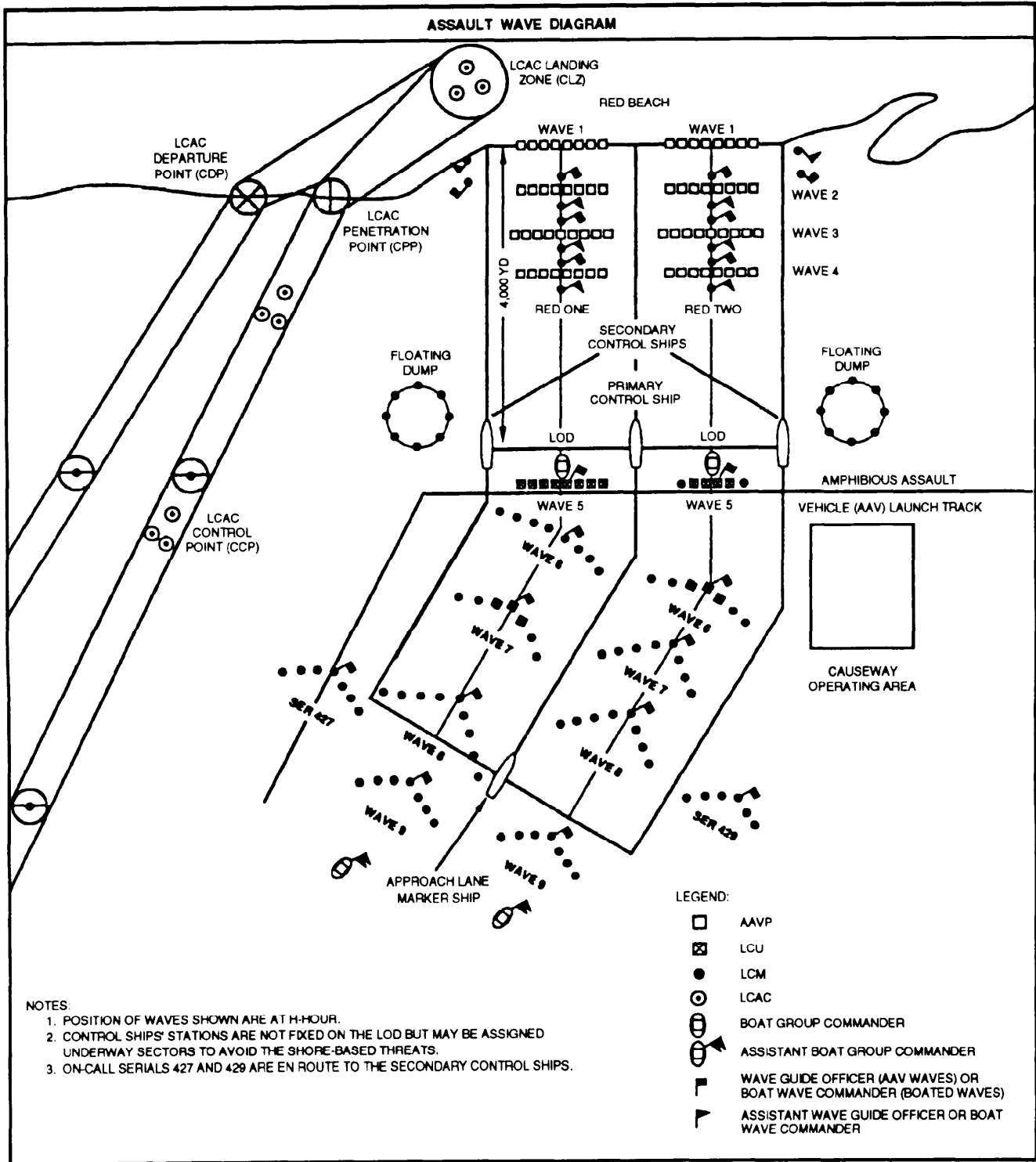

73NP0082

Figure 12-5.—Example of an assault wave diagram.

their final movement to the beach. When landing beaches are separated, each beach has its own LOD, which may be marked by a ship or ships of the control organization or by boats or buoys. In some landings the LOD may not be marked.

Boat Lanes

Boat lanes extend seaward from the landing beach to the LOD. The length of the landing beach determines the width of the boat lane. The flanks of the boat lane may be marked at the LOD by a control ship, a marker boat, or a buoy.

Approach Lanes

Approach lanes are extensions of the boat lanes from the LOD towards the transport area. They may be terminated by marker ships, boats, or buoys. Adjacent approach lanes may be parallel or may diverge seaward to provide for early dispersion of the

assault waves. Approach lanes indicate the exact routes for craft to use in approaching the LOD.

IDENTIFICATION OF DEBARKATION STATIONS

There is a maximum of ten debarkation stations, five on the starboard side and five on the port side, each identified by color and number (odd-numbered, starboard; even-numbered, port). See figure 12-4.

PROCEDURES FOR CALLING BOATS ALONGSIDE

Signals are used to call boats and landing craft from the assembly areas to embark troops at the debarkation stations.

Day

The starboard and port yardarms are used to signal for the starboard and port debarkation stations, respectively. The type of boat or craft is called to the

Information to Signal		Day Signal Flag	Night Signal Lights
Sides	Starboard Port	Use starboard yardarm Use port yardarm	Top GREEN light Top RED light
Boats and Displacement Landing Craft	LCPL LCU AAV LCM 6 LCM 8	L FLAG U FLAG T FLAG 6 FLAG 8 FLAG	Middle AMBER light Middle WHITE light Middle AMBER light, flashing Middle BLUE light Middle Green light
Stations	Color Starboard Port		
	RED 1 2	REDFLAG	Bottom RED light
	WHITE 3 4	WHITEFLAG	Bottom WHITE light
	BLUE 5 6	BLUEFLAG	Bottom BLUE light
	YELLOW 7 8	YELLOW FLAG	Bottom AMBER light
	GREEN 9 10	GREEN FLAG	Bottom GREEN light
Well Deck/ Tank Deck	Note: Paragraph A. 1.4. of NWP 22 contains special signals for the LHA well deck.	WHISKEY FLAG	Top WHITE light Middle (type landing craft indicated by middle light marry up and enter well deck) Bottom WHITE light Note: Turned off for calling single landing craft into well deck or to tank deck

Figure 12-6.—Signals for calling boats and landing craft to debarkation stations.

station by displaying the designated flag over the colored debarkation station flag (see fig. 12-6). For example, to call the LCM 8 required at (port) debarkation station BLUE 6, the signal bridge hoists the 8 flag over the BLUE flag at the port yardarm. When boats are alongside the designated station, the flag signal is hauled down.

Night

A light box (fig. 12-7) is mounted on a swivel base at the signal station on each side of the ship for aiming at a particular assembly area. The box is fitted with three holes on a vertical line and is shielded at the front so the lights are visible in one assembly area only. The holes will be of such size to permit interchange of the standard colored light filters for a 12-inch searchlight.

The top color in the light box indicates starboard or port side; the middle color indicates type of boat or craft desired; and the bottom color designates the debarkation station (see fig. 12-6).

Each debarkation station suspends a small, single-cell flashlight colored the same color as the debarkation station marker. All lights are in the same location as the station marker painted on the hull. These small lights serve only to identify the stations as the boat or craft comes close alongside.

Day and Night

Landing craft are called alongside by signal on orders from the debarkation officer. Loudspeaker equipment may be used as a supplementary means of

communication. Radio to the boat group commander (BGC) or his or her assistant may be used as a backup.

PROCEDURES FOR CALLING BOATS AND CRAFT INTO WELL DECKS/TANK DECKS

Signals are used to call boats and landing craft from on-call circles into the well decks, to the tank of an LST for stern gate marriages, or to embark troops or cargo.

Day

Signals are similar to those used in calling boats or craft to debarkation stations. To call boats or craft into well decks, the signal bridge hoists the signal for a type of boat or craft (see fig. 12-6). To call an LCM 8, for example, the signal bridge hoists (on either yardarm with the exception of LHAs) flag 8 over flag WHISKEY, which would tell the boats in the on-call circle that a single LCM 8 is to enter the well deck. To bring two LCM 8s married into the well, the signal is flag 8 over flag 8 over flag WHISKEY. This indicates that two LCM 8s are to marry up in the on-call circle and enter the well deck. Once the boats cross the sill, the well deck control officer positions them at any desired station. For calling boats or craft into the well deck of an LHA, the signal bridge hoists flag signals on the port or starboard yardarm to indicate which side of the split well deck the boat or craft is to make.

To call LCUs or LVTs to the tank deck, the signal bridge hoists the appropriate flag over the WHISKEY flag from either yardarm.

Night

At night, the light box and the same middle light color signals are used for calling individual boats and craft alongside. The top light for calling boats to the well deck is white instead of red or green. The bottom light is left blank when single boats are called. To have boats marry up, the bottom light is white. For LHAs, a steady top light indicates a boat or craft is to make the starboard side of the split well deck. A flashing top light indicates the port side of the split well.

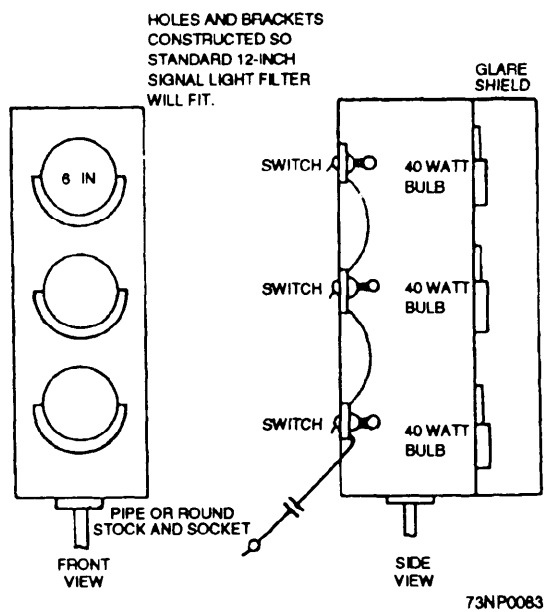

Figure 12-7.—Debarkation light box.

CONTROL ORGANIZATION

LEARNING OBJECTIVES: Explain the duties of the control organization personnel, including the duties of the central control officer (CCO), a BGC, and the BWC.

This section discusses the duties and organization of control personnel and the procedures for coordinating the various ships for an amphibious operation.

CENTRAL CONTROL OFFICER (CCO)

The CCO is designated by the CATF for overall coordination of the waterborne assault. This officer is embarked on the control ship, and his/her responsibilities include the following:

- Planning and supervising the waterborne ship-to-ship movement
- Organizing the Navy control group to support the ATF landing plan
- Maintaining liaison with the tactical air officer (TAO)
- Maintaining liaison with the tactical logistics (TACLOG) group

ASSISTANT CENTRAL CONTROL OFFICER (ACCO)

An ACCO may be designated if the scope of the operation requires it. He/she embarks in an appropriate ship or craft and coordinates, as necessary, the movement of landing craft, amphibious vehicles, and landing ships in his/her designated area.

PRIMARY CONTROL OFFICER (PCO)

A PCO is designated for each colored beach and is responsible for the following:

- Providing detailed plans, called PCO instructions, to conduct the ship-to-shore movement for amphibious assaults or withdrawals across a colored beach
- Maintaining current location and status of all ships, landing craft, and boats assigned to conduct the landing on the assigned beach
- Monitoring surf conditions and weather predictions and recommending the termination of boating when conditions warrant
- Maintaining the status of debarkation or embarkation
- Landing scheduled waves at the correct beach at the specified time

- Arranging for fueling boats and providing rest and food for boat crews
- Providing liaison to the surfaceborne RLT TACLOG detachment
- Conducting assault craft salvage operations
- Coordinating the employment of landing ships and craft within his or her area of responsibility following the initial assault

SECONDARY CONTROL OFFICER (SCO)

The SCO embarks in the secondary control ship (SCS) and is a principal assistant to the PCO. The SCS is assigned a fixed point station on the LOD or underway sector in the vicinity of the PCS; SCO\SCS duties include the following:

- Maintaining duplicate control records and plots required of the PCO and PCS
- Monitoring PCO radio circuits
- Controlling the waterborne ship-to-shore movement over a numbered colored beach when two or more numbered beaches are designated for colored beach
- Assuming PCO and PCS duties in an emergency

BOAT GROUP COMMANDER (BGC)

The BGC is embarked in an LCPL displaying the ZERO flag over the beach flag and is under the tactical control of the PCO. The BGC is thoroughly briefed on the approach schedule; assault wave, landing area, and transport area diagrams; and weather conditions; and is responsible for the following:

- Maintaining discipline within the boat group
- Maintaining proper wave positions in the rendezvous area
- Leading the first displacement landing craft wave from the rendezvous or underway launch area to the surf zone
- Controlling waterborne traffic off the beach

After the last scheduled wave has landed, the BGC assumes the duties as the traffic control officer (TCO) for the beach.

ASSISTANT BOAT GROUP COMMANDER (ABGC)

The ABGC embarks in an LCPL displaying the WHISKEY flag over the beach flag and reports to the BGC. The ABGC is responsible for the following:

- Assuming BGC duties in an emergency
- Assisting in organizing waves into proper position in the rendezvous area
- Assisting in dispatching waves from the rendezvous area to arrive at the LOD on time
- Checking for stragglers or malfunctioning/damaged assault craft in later waves
- Following the last scheduled wave to the surf zone
- Conducting landing craft and amphibious vehicle salvage operations

Upon departure of the last scheduled wave from the rendezvous area, the ABGC becomes the senior salvage officer afloat and reports to the beachmaster for duty.

BOAT WAVE COMMANDER (BWC)

The BWC embarks in the number one displacement landing craft and displays the beach flag over the wave number numerical flag. The BWC communicates with the BGC, ABGC, and PCS and is responsible for the following:

- Forming the wave into proper organization for landing
- Maintaining boat discipline in the wave
- Maintaining proper boat and wave intervals
- Arriving at the LOD and beach on time

WAVE GUIDE OFFICER/ASSISTANT WAVE GUIDE OFFICER

A wave guide officer and an assistant wave guide officer are assigned to each wave of amphibious vehicles. They are normally provided by the ship in which the wave is embarked. Each officer embarks in an LCPL that is equipped for communication the same as the BWC's craft. The wave guide officer's duties are as follows:

- Forming up the amphibious vehicles and guiding them to position seaward of the LOD line.

- Reporting to the PCS, giving details affecting the readiness of his/her wave.
- Taking station ahead of the wave, with his/her assistant astern of the wave, and leading the wave to the LOD and across on signal from the PCS.
- Ensuring that the wave is maintaining proper position in the boat lane and reaches the proper beach on time. (This officer is assisted by directions from the PCS.)
- Guiding the wave to the first line of breakers. Here the wave guide boats take station in the return lane if the amphibious assault vehicles are to return seaward after landing, and guide returning vehicles to the designated control ship or boat haven. If the vehicles do not return seaward, the guide boats normally report to the PCS.

STANDARD IDENTIFICATION FLAGS, LIGHTS, MARKERS, AND SIGNALS

LEARNING OBJECTIVE: Identify the standard identification flags, lights, markers, and signals used in ship-to-shore movement.

A variety of standard identification flags, lights, and markers are used in the ship-to-shore movement (refer to NWP 22-3, appendix C). In addition, a number of special markers and signals are used, as described in later paragraphs of this chapter.

BEACH MARKING FLAGS AND PANELS

During the planning stage of an amphibious assault, beach areas are divided into sections and assigned colors for identification purposes. Beach markers are approximately the size of a No. 4 flag, and are with the normal beach colors of red, yellow, green, or blue. Fluorescent cloth is used in beach flags and markers wherever possible for greater ease in identification under all weather conditions.

BEACH FLAGS

Beach flags (fig. 12-8) are flown from designated boats and ships; the color and design of the flag corresponds to the beach assignment. When not otherwise specified, the size of flags flown from boats will be a No. 8 signal flag or larger. Fluorescent cloth

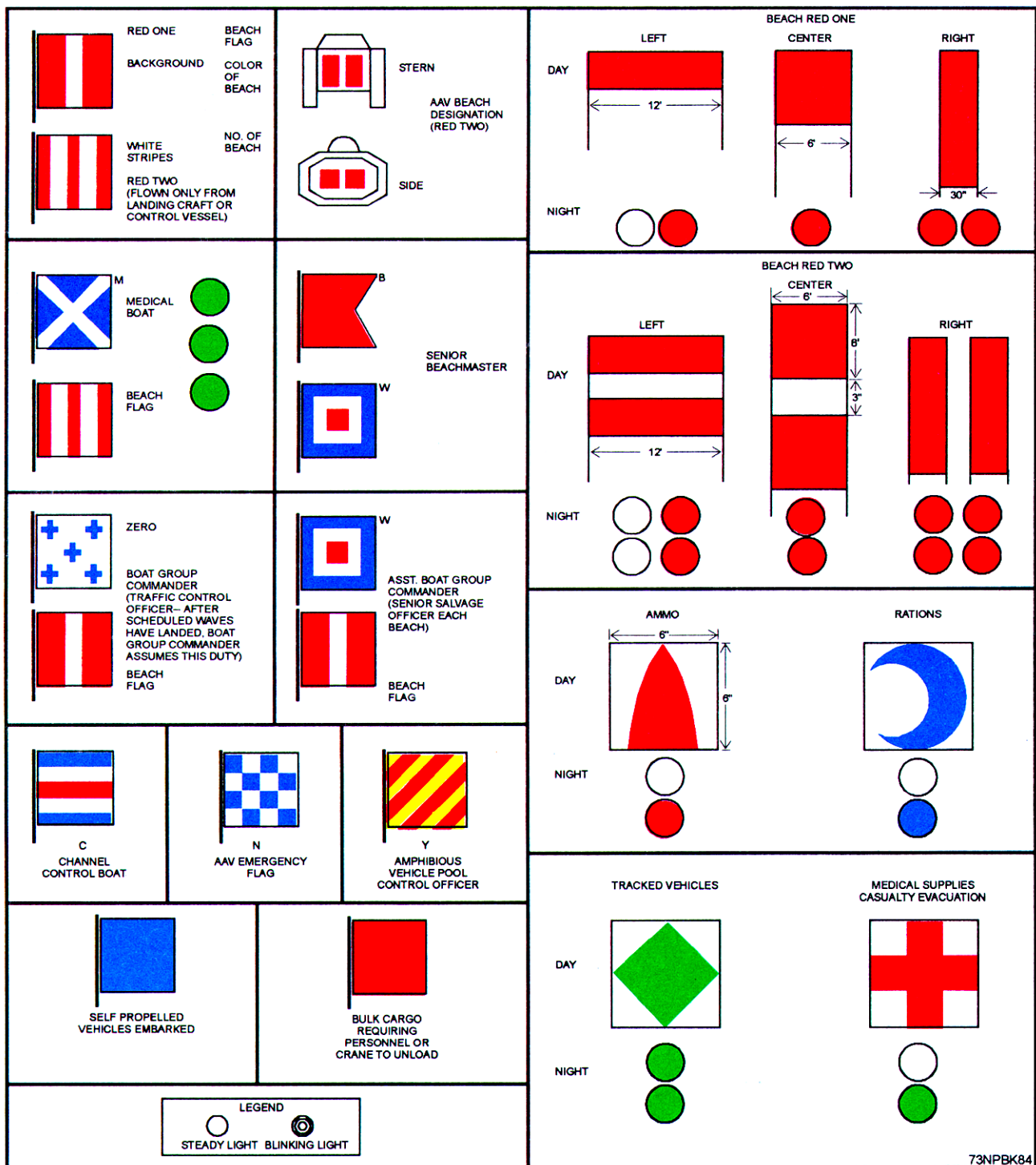

73NPBK84

Figure 12-8.—Beach flags, markers, and signs.

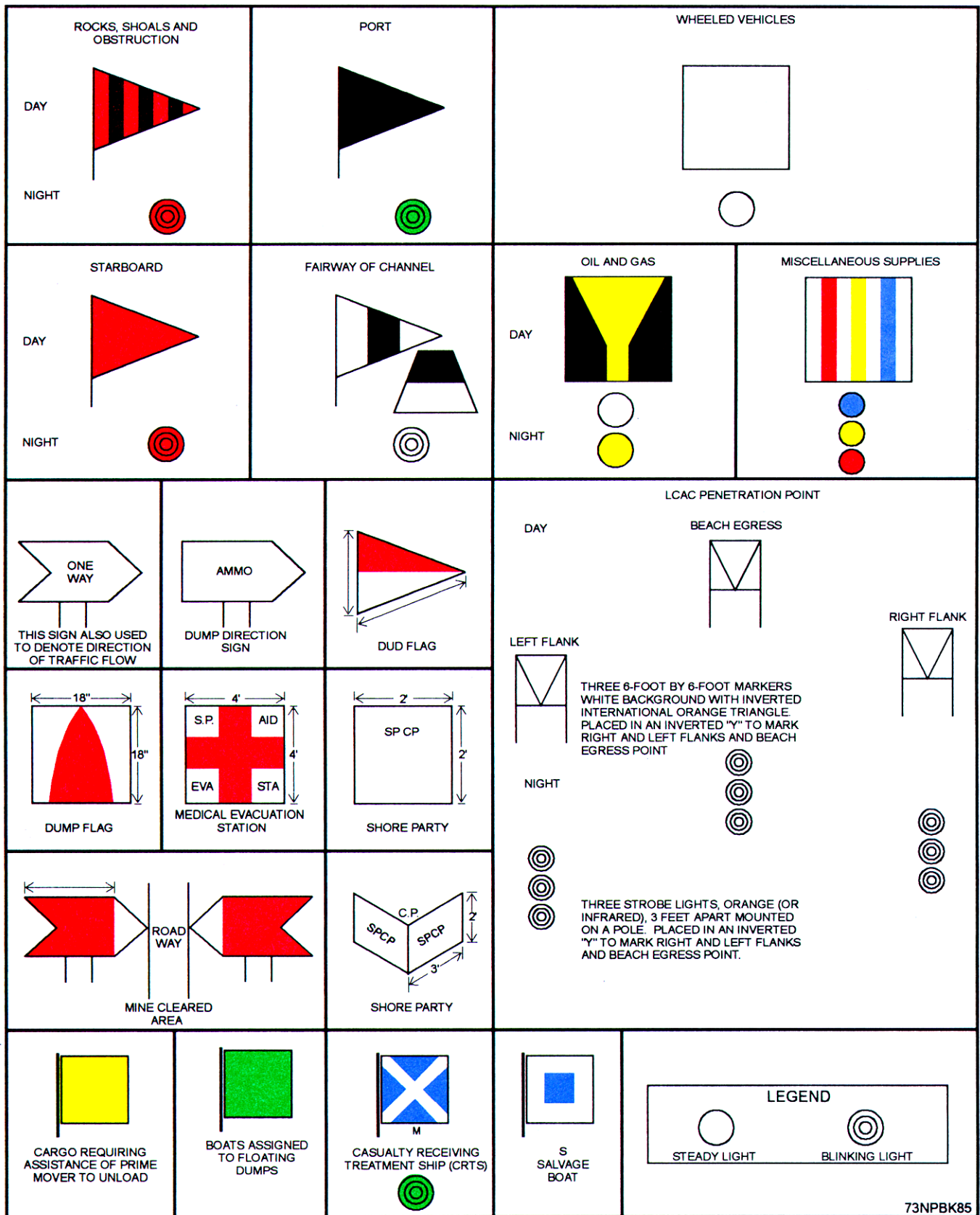

73NPBK85

Figure 12-8.—Beach flags, markers, and signs—Continued.

is used in beach flags and markers whenever possible for greater ease in identification.

SIGNAL OR MARKER LIGHTS

Signal or marker lights should be of sufficient intensity to be visible at a distance of at least 1,000 yards. Beach and unloading marker lights should be directional with not over 10-point visibility to seaward only. Should marker lights conflict, unloading-point marker lights may be one-half the intensity of beach center and flank markers.

DISPLAY OF STANDARD FLAGS AND MARKERS

Boats, craft, and amphibious vehicles in scheduled waves should remove from sight all special designators, such as flags and boat team paddles, at the time of crossing the LOD. Required designators should again be displayed following the landing of the last scheduled wave, or earlier if directed by the beachmaster, as shown in figure 12-9.

FLAG REQUIREMENTS

All wave guide officer, BWC, salvage, medical, safety, and ABGC boats should carry the ZERO, the WHISKEY, and the numeral flags for all waves in order to facilitate substitution of one boat for another, if required.

NIGHT AND LOW-VISIBILITY SIGNALS

At night and during conditions of low visibility, colored lights should be used instead of flags and other daylight markers. All-around lights, except oceanographic markers, should be displayed only after H-hour. During darkness, screened wake lights should be used on the sterns of all assault boats and vehicles. Lights should be displayed as indicated in figure 12-10.

BOAT TEAM PADDLES

Each boat team should be provided with a boat team paddle on which is prominently marked the boat team number that is shown in the landing craft and amphibious vehicle assignment table. A member of each boat team should be designated to display the paddle prominently at all times that the team is in the landing craft or amphibious vehicle, until the LOD has been crossed.

1. Paddle Number—The number on the paddle indicates both the scheduled wave number and the position of the boat or amphibious vehicle in that wave. The first digit(s) indicate(s) the wave; the last digit(s), the position within the wave. For example, boat team paddle 2-3 (fig. 12-11) indicates the third boat or amphibious vehicle in the second wave; boat team paddle 9-3 indicates the third boat or amphibious vehicle in the ninth wave. Each coxswain should be furnished with a copy of the landing diagram showing wave composition and timing.

2. Visibility—Boat team paddles are constructed for good visibility at a considerable distance, yet are easy to handle. They are three-sided, readable from any direction, with black numerals on a white background. Paddles are made to the following specifications:

- Three rectangularly shaped boards, 14 by 10— inches, nailed together to form a three-sided figure, attached to a wooden staff 6—feet by 2— inches by 2— inches
- Black numerals, 7— inches high, on a white background

3. Boats carrying serials and free boats—These boats should display paddles on which is clearly marked the serial number of the embarked serial. Each ship is responsible for ensuring that boats carrying serials unloaded from that ship clearly display the correct serial numbers. The numbers must be displayed constantly until the landing craft has beached.

Cargo Identification

Boats carrying various types of cargo display distinctive flags or lights so control and beach party personnel may readily identify the type of cargo embarked. The colored and numeral flags or colored lights used to identify various types of cargo are listed in figure 12-12. For example, a boat that is assigned to a floating dump and carries flame-thrower fuel flies a 3 flag under a GREEN flag or, at night, shows a fixed RED light under a fixed GREEN light.

Load Dispatching Signals

All signals normally are paralleled by voice radio from the central control ship. All lights used are shielded and aimed at the approaching wave only.

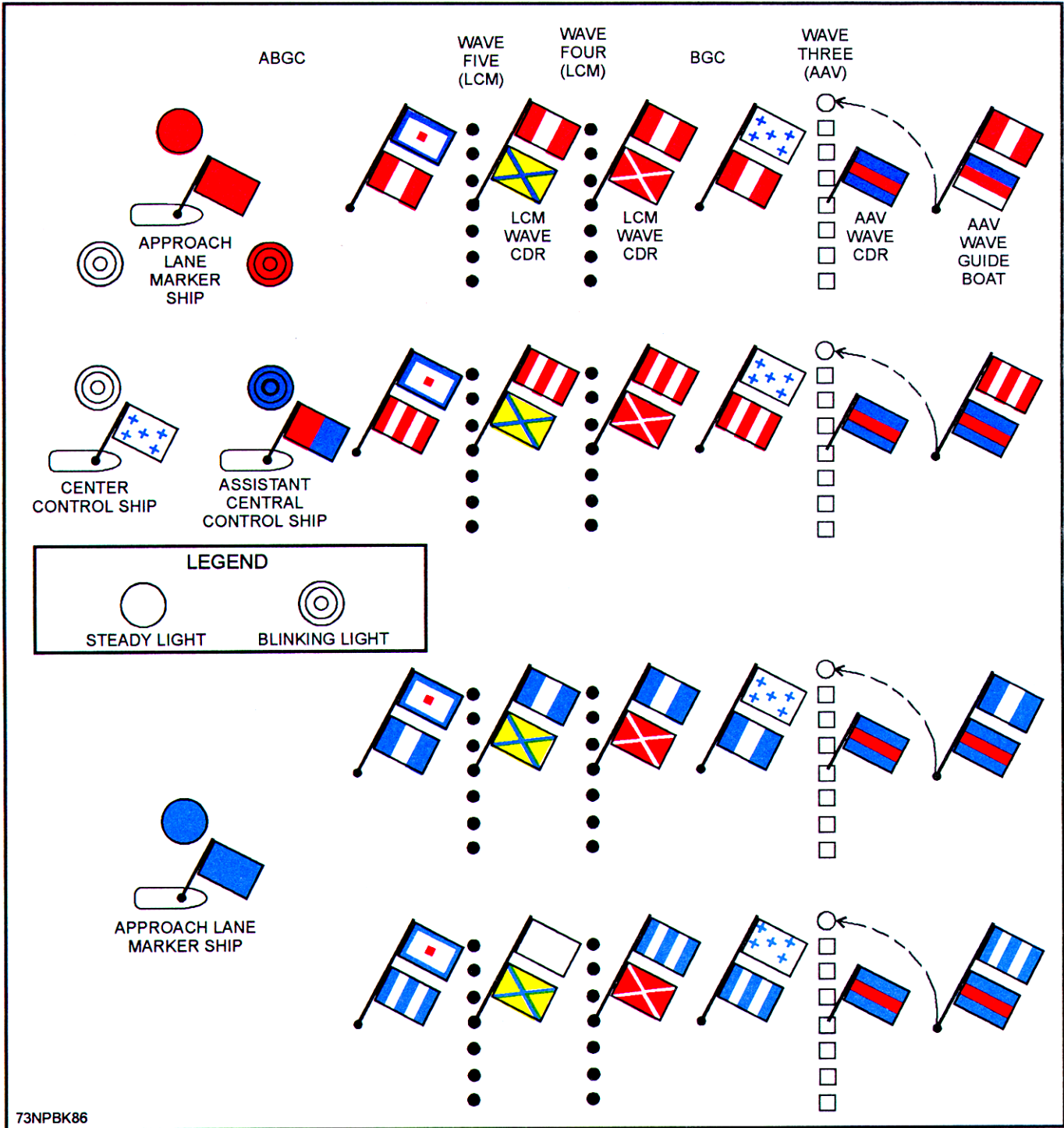

73NPBK86

Figure 12-9.—Standard flags and identification insignia.

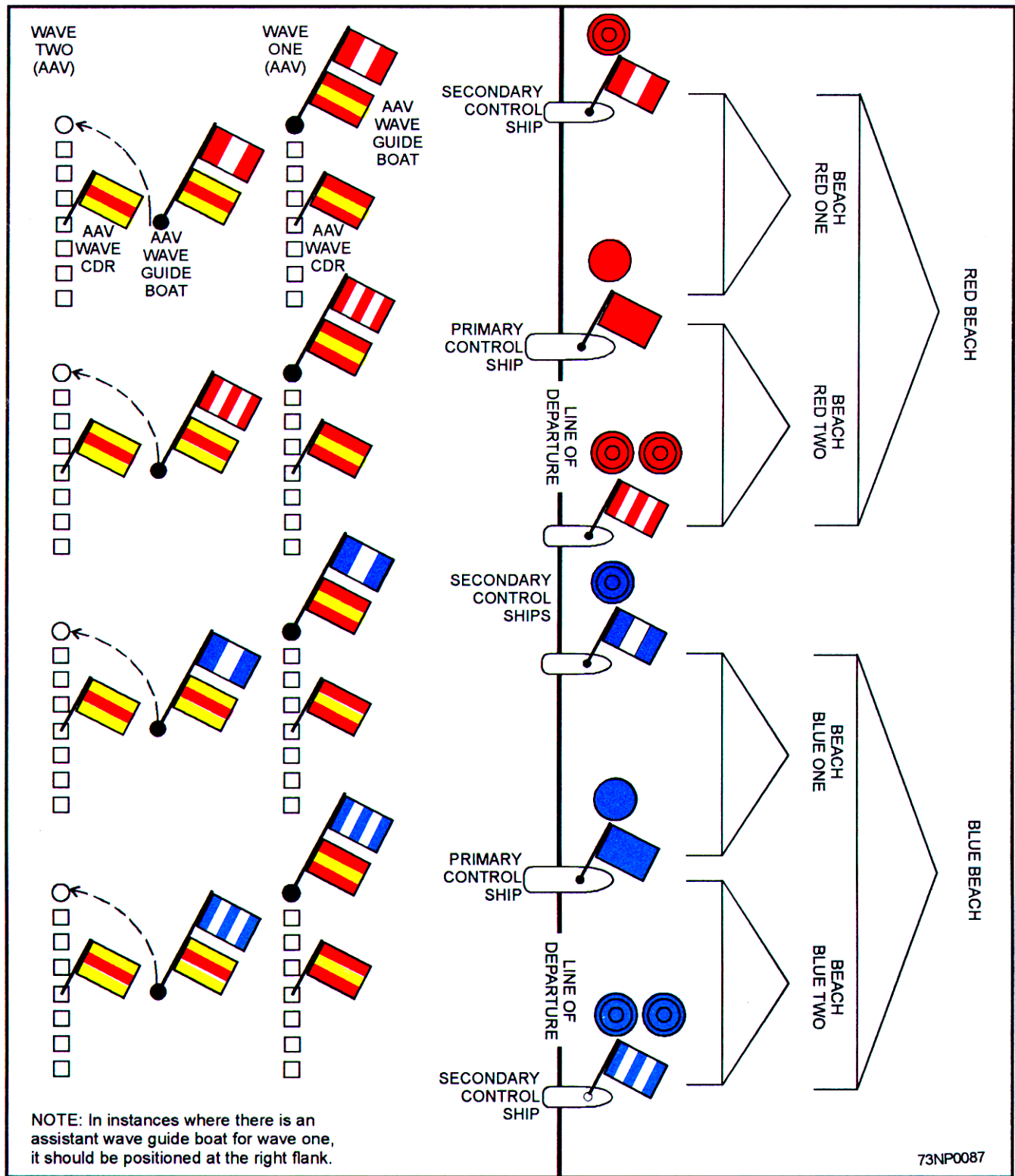

Figure 12-9.—Standard flags and identification insignia—Continued.

	Light
<p>a. Ships, Boats, and Landing Craft</p> <p>Central Control Ship Assistant Central Control Ship Primary Control Ship</p> <p>Secondary Control Ship Approach Lane Marker Ship Boat Group Commander (Traffic Control Officer)</p> <p>Assistant Boat Group Commander (Senior Salvage Officer) Boat Wave Commander Wave Displacement Landing Craft Salvage Boats</p> <p>Medical Boats Floating Dumps</p>	<p>2, vertical, blinking WHITE 2, vertical, blinking, color to be designated 1, steady, directed seaward, same color as beach (all-around after 1st wave touches down)</p> <p>1, blinking, same color as beach 1, steady, same color as beach, directed seaward 3 wake lights, vertical, 1 foot apart, same color as beach (convertible to all-around) 3 wake lights, horizontal, 2 feet apart, RED (convertible to all-around) 2 wake lights, vertical, 1 foot apart, same color as wave 1 or 2 wake lights, horizontal, colored (see c) 3 wake lights, horizontal, 2 feet apart, RED (convertible to all-round) 3, vertical, steady, 1 foot apart, GREEN, all-around 2 or 3 vertical (1 steady GREEN over 1 to 2 cargo colors, 2 feet apart (see figure 12-12)</p>
<p>b. Ocean Markers and Navigation Aids</p> <p>Obstruction Channel, port side Channel, Starboard side Fairway</p>	<p>Blinking WHITE over blinking RED Blinking GREEN Blinking RED Blinking WHITE</p>
<p>c. Screened Wake Lights</p> <p>1st Wave 2nd Wave 3rd Wave 4th Wave 5th Wave 6th Wave 7th Wave 8th Wave Successive Waves</p>	<p>1 RED 1 BLUE 1 AMBER 1 GREEN 2 RED (see note) 2 BLUE (see note) 2 AMBER (see note) 2 GREEN (see note) Repeat entire sequence</p>
<p>Note: Two lights, horizontal, 3 feet apart.</p>	

Figure 12-10.—Wave Lights requirements.

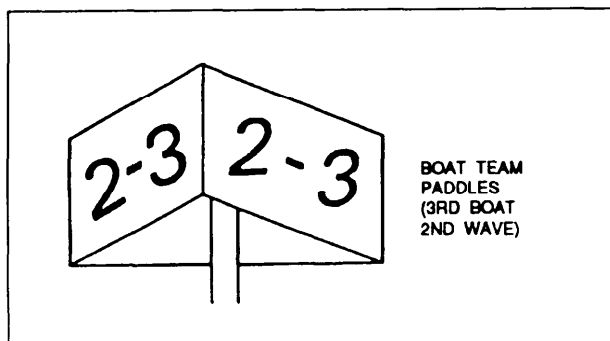

Figure 12-11.—Boat team paddle.

Departure

Departure time sequence is shown in figure 12-13. For a 5-minute standby for wave one, the ONE flag will be placed at the dip. The nighttime signal is a steady RED light for 30 seconds. For a 2-minute standby, the ONE flag is closed up, and the nighttime signal is a flashing RED light for 30 seconds. The nighttime signal for a 1-minute standby is a flashing RED light for 50 seconds, then a 10-second steady RED light. There is no daytime signal for a 1-minute

Floating Dump Supplies	Day	Night
	Green flag light over cargo flag	Steady GREEN light over cargo color light(s), 2—feet apart
Rations	ONE flag	1 steady WHITE light
Medical supplies	TWO flag	1 steady GREEN light
Water	Four flag	1 steady BLUE ight
81-mm Ammunition	FIVE flag	1 steady AMBER light
Bulk Cargo	RED flag	2 steady RED lights
Self-Propelled Vehicles	BLUE flag	2 steady BLUE lightrs
Cargo Requiring Prime Mover	YELLOW flag	2 lights, steady BLUE over steady AMBER

Figure 12-12.—Floating dump cargo identification.

Wave	Departure	Day	Night
Wave One	5 minute 2 minute standby 1 minute standby	One flag at dip One flag close-up — — —	Steady RED light for 30 seconds Flashing RED light for 30 seconds Flashing RED light for 50 seconds then a 10-second steady RED light
	Departure time	One flag hauled down to dispatch wave	Extinguish 10-second steady RED light to dispatch wave
Wave Two	2 minute standby	Numeral flag of wave close-up	Flashing BLUE light for 30 seconds
	1 minute standby	— — —	Flashing BLUE light for 50 seconds, then a 10-second steady BLUE light
	Departure time	Numeral flag hauled down to dispatch wave	Extinguish 10-second steady BLUE light to dispatch wave
Wave Three		Same as wave two	AMBER light is used
Wave Four		Same as wave two	GREEN light is used
Wave Five		Same as wave two	RED light is used
Wave Six		Same as wave two	BLUE light is used
Successive Waves		Continue using cycle outlined above for waves three through six	

Figure 12-13.—Departure time sequence.

standby. For dispatching during daytime, the ONE flag will be hauled down; and for nighttime, extinguishing of the 10-second steady RED light. The color lights for wave two will be blue; wave three, amber; wave four, green. After wave four, the color of lights starts repeating: wave five would be red; wave six, blue; and so on. After the 5-minute standby for wave one, no other 5-minute standby will be used.

Numeral flags are normally flown from both port and starboard yardarms. However, waves on both sides might not be scheduled to land at the same time. In that case, the PCS hoists the appropriate signal on the yardarm on the side of the ship the wave is scheduled to pass. Waves with two-digit numbers are dispatched by a hoist using the numeral flag corresponding to the last digit of the wave number.

In addition to megaphone, radio, and blinker messages, various visual signals are used in beach operations, as shown in NWP 22-3, appendix C.

Visual Emergency Signals for Boats

The following signals are visual emergencies:

OSCAR flag—Man overboard

Life jacket on perpendicular boat hook—Breakdown

BRAVO flag—Fire/flooding

ZULU flag—Loss of receive/transmit communications

GRID REFERENCE SYSTEM

LEARNING OBJECTIVES: Explain the purpose of the grid reference system. Identify procedures for using it.

The amphibious grid reference system is used primarily to control waves moving in the lanes from the rendezvous area to and across the LOD and until they land on the assigned beach. The grid is an overlay composed of a series of boat lanes (LOD to beach), one for each scheduled wave. Each boat lane is marked with the time and speeds applying to that specific wave. A standard voice procedure is used that reduces voice transmissions to a minimum while transmitting accurate positions to the waves. The procedure virtually eliminates the probability of “pyramiding” vectors to the waves.

The system may also be used in the approach lanes and enroute from the parent ship or transport area to the rendezvous area or LOD provided frequencies are assigned that prevent interference. Boat waves or nonscheduled units may be guided effectively by this system during periods of darkness or reduced visibility.

BEFORE DEBARKATION

Before debarkation of the boats and amphibious vehicles of an amphibious assault, the BGC, all BWCs, and all wave guide officers are issued a gridded diagram of the boat lane to be used (see fig. 12-14). The diagram is an approximate picture of the boat lane from the rendezvous area to the beach.

- Longitudinal lines in the diagram divide the lane into three sections: L (left), C (center), and R (right). Left and right sections are each 40 percent of the total width; the center section is 20 percent of the total width.

- Lateral lines are drawn at 200-yard intervals along the lane and are numbered to indicate distance to go in hundreds of yards.
- Lane positions are described by a letter (*L*, *C*, or *R*) followed by a number of one or two digits. Positions outside the lane are indicated by a double letter: *RR* or *LL*.

Time lines should be plotted on the grid overlay by the following method:

- Using the given wave speed of advance (SOA) and touchdown time, determine LOD crossing time for that wave.
- For the final 1,000-yard transit, waves will be making battle speed (BS); therefore, count backwards from touchdown time to the BS line, accounting for the complete time (whole minutes and fractions).
- Divide the time from LOD to BS, again accounting for every whole minute and fraction.
- Label all times on the boat lanes blank, as shown in figure 12-14.
- When more than one wave is being controlled, the time clock will be divided into four primes:

Prime	Time (Seconds)	Waves Marked
0	52 1/2 to 07 1/2	1, 5, 9
1	07 1/2 to 22 1/2	2, 6, 10
2	22 1/2 to 37 1/2	3, 7, 11
3	37 1/2 to 52 1/2	4, 8, 12

If the 15-second primes for grid construction (and grid position transmission) are used, the complete time for the transit can be accounted for.

The control party has the gridded boat lanes plotted to scale in CIC, one lane for each wave to be tracked and controlled, to minimize confusion and obtain a clear and concise picture of the movement of each wave.

RENDEZVOUS AREA

In the rendezvous area, boats should be provided navigational assistance to keep the waves in their rendezvous circles. In addition, CIC tracks the waves and fixes the position of each wave on the grid upon the departure of the waves from the rendezvous area. The control party then transmits the position to the BWC by flashing light or by voice radio. The BWC, on receipt of a grid position that indicates the wave is

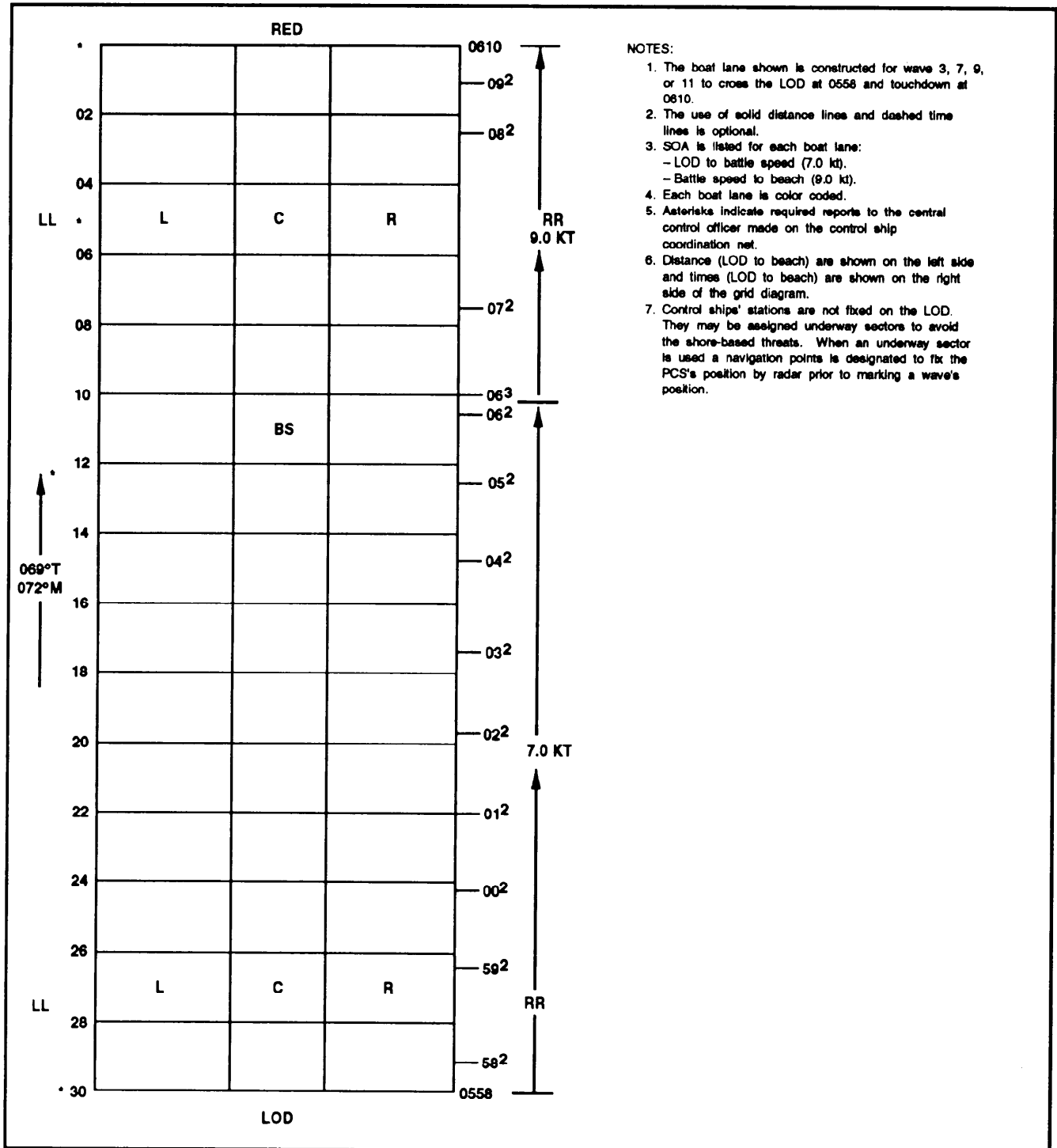

73NP0089

Figure 12-14.—Amphibious grid reference system.

not in the center of the proper lane and/or not progressing along the lane according to schedule, corrects the position and movement of the wave. Control officers supplement grid positions with vectors and “early” or “late” information as necessary.

Grid positions normally are transmitted every minute from the rendezvous area to 200 yards from the beach unless corrective action is required, in which case they are transmitted more frequently. Grid positions will be provided once each minute in periods of low visibility, from the predesignated assembly

circle to the beach. The last 1,000 yards to the beach is run at full (battle) speed. However, the control group commander should ensure that wave one never arrives early, because of the hazards from pre-H-hour neutralization fires, the difficulty of terminating such fires early, and the necessity for beach preparation by such fires.

To obtain full benefit from the grid and to track the wave's progress, wave commanders will plot their position each time the controlling station transmits it. The effects of wind and sea and/or taking incorrect headings can thus be determined and corrected. Once firm radio communications are established, grid positions can be transmitted without requiring wave commanders to receipt. However, vectors should be receipted for. If the wave commander fails to receipt for orders by radio, the primary control ship will continue to transmit "blind" and request visual acknowledgment.

COMMUNICATION CIRCUITS

Two nets are designated for each colored beach: channels ALFA and BRAVO. Channel ALFA is a direct net, used by the PCS to pass grid positions and boat wave directions to the BWCs and wave guide officer from the LOD until touchdown. Channel BRAVO, the beach boat operations net, is used by the PCO/PCS and ships to control assigned boats before they are dispatched to the beach. Touchdown reports and operational/administrative traffic between control ships and boats are passed on to this station. Good judgment should be used when using the net, to avoid cluttering.

Voice Calls

Voice calls on the control group net and beach boat operation net use daily changing call signs. The beach boat control net uses JANAP 119 call signs. Additionally, the boat group commander uses the JANAP 199 call signs on all nets to avoid confusion with wave call signs.

Voice Transmissions

The following are examples of voice transmissions:

Turnover from parent ship to PCS (channel BRAVO)

"____ ONE, THIS IS____ SWITCH TO CHANNEL ALFA AND REPORT TO____ FOR CONTROL AND VECTOR TO THE BEACH. OVER."

Reporting it to PCS (ALFA)

"____, THIS IS TWO BLUE ONE. REPORTING FOR CONTROL AND VECTOR TO THE BEACH. OVER."

Positive control

"TWO BLUE ONE, THIS IS____ HOLD YOU UNDER POSITIVE RADAR CONTROL. STEER COURSE ____ AND SPEED ____ FOR THE LOD. SET AND DRIFT AT THE LOD IS (DIRECTION) AND (SPEED, IN KNOTS). OVER."

"TWO BLUE ONE, THIS IS____. DO NOT HOLD YOU UNDER POSITIVE RADAR CONTROL. MAINTAIN PRESENT COURSE AND SPEED (POSITION). OVER."

"ONE BLUE ONE, THIS IS____ HOLD YOU UNDER POSITIVE RADAR CONTROL. STEER COURSE____ AND SPEED____ FOR THE LOD. SET AND DRIFT AT THE LOD IS (DIRECTION) AND (SPEED, IN KNOTS). MY INTENTION IS TO EXECUTE A LEFT (RIGHT) FLANKING MOVEMENT SEAWARD OF THE LOD. OVER."

Dispatch from LOD

"TWO BLUE ONE, THIS IS____. YOU ARE DISPATCHED FROM THE LOD TO THE BEACH. STEER COURSE____, SPEED____. OVER."

LOD crossing report (control group net)

____, THIS IS____. TWO BLUE ONE CROSSED LOD LATE ONE HALF. OVER."

Grid posits (ALFA)

"TWO BLUE ONE, THIS IS____. GRID POSIT ROMEO THREE EIGHT OUT." (Wave 2 Blue 1 is right side of boat lane, 3,800 yards from the beach and on time.)

TWO BLUE ONE, THIS IS____ GRID POSIT ROMEO THREE TWO EARLY ONE. OUT." (Wave 2 Blue 1 is right side of boat lane, 3,200 yards from beach and is ahead of schedule 1 minute.)

Vectoring waves (ALFA)

"TWO BLUE ONE, THIS IS____ GRID POSIT ROMEO THREE ZERO EARLY ONE. VECTOR LEFT TEN. OVER." "TWO BLUE ONE, THIS IS____ GRID POSIT ROMEO, ROMEO TWO SEVEN EARLY ONE. VECTOR LEFT TWENTY. OVER."

Battle speed (ALFA)

“TWO BLUE ONE, THIS IS _____ GRID POSIT CHARLIE ONE ZERO. BATTLE SPEED. BATTLE SPEED. OVER.”

Touchdown report (wave) (channel ALFA)

“_____, THIS IS TWO BLUE ONE. TOUCHDOWN, TOUCHDOWN, TOUCHDOWN. OVER.”

Touchdown reports (control group net)

“_____, THIS IS _____. TWO BLUE ONE TOUCHDOWN. LATE ONE QUARTER. OVER.”

Governing Notes

The following governing notes are to be used when communicating to waves:

- _____, where appearing, indicates daily changing Call signs.
- The shift to channel ALFA can be ordered by PCS when desired, but no later than when boat waves cross the LOD. If no channel shift order is given, boat waves will automatically shift to channel ALFA upon crossing the LOD.
- Amphibious assault vehicle (AAV) waves require an intention statement from PCS when PCS takes positive control.
- A full call-up is required for all transmissions to ensure that the proper wave received the information. When ordering courses to boat waves, make sure they are given in magnetic degrees.
- All reports to the CCO should include a time status. Fractions of minutes are spoken one-quarter, one-half, three-quarters, and so forth.
- Because many boat compasses are unreliable, it is best to change the course of boats by vectors of 10 degrees to 30 degrees instead of course headings. To minimize the initial error and consequent loss of time, the BGC, ABGC, and all BWCs should check and compare their magnetic compass headings with the PCS while transmitting from the wave-forming circles to the landing craft rendezvous area. Vectors may be given at any time to maintain a wave's position in the boat lane center. However, vectors should be held to 10 degrees or less in the surf zone for boat safety.

- Waves outside the boat lanes must be vectored to regain boat lane positioning.
- Prior to the order for BS, speed changes may be given at any time to keep waves on time. Speed changes must be ordered when waves are early or late 2 minutes or more.
- BS must be ordered at the 1,000-yard mark. Even if a wave is doing maximum speed before the 1,000-yard mark, the order “BATTLE SPEED” is still mandatory at that time.
- Note that all information transmissions end in OUT and those directing waves to perform a duty end in OVER. If at any time you desire a wave to acknowledge receipt of information, end the transmission with OVER, thus requiring an answer.
- Dispatched orders are not required if waves have been shifted to channel ALFA or the shift to channel ALFA upon each wave's crossing LOD is provided for in the OORDER or prebrief.

VISUAL PROCEDURES FOR TRANSMITTING GRID POSITIONS

LEARNING OBJECTIVE: Explain procedures for visually transmitting grid positions.

Grid positions by flashing light or Nancy will normally be preceded only by flashing the wave number. However, if confusion would result from transmitting into different numbered boat lanes or different colored beach lanes, it will be necessary to modify the call accordingly. For example, to call the wave commander of Wave Three, Blue Beach Two, the normal call-up is the numeral 3. If confusion would result, and it is therefore necessary to send the complete call, the call is transmitted as numeral 3, Blue, numeral 2. The control ship, after establishing communications with the wave commander, then transmits the grid position.

The wave commander receipts for each group by flashing a *T* with his or her signal equipment and receipts for the message with the usual *R*.

Visual grid positions and information are transmitted by control ships using the procedures in the following paragraphs.

After the wave call-up, insert the group GP. This acts as a proword and alerts the receiver that a grid position is to follow.

Transmit the grid position using letter *L* for left, *C* for center, *R* for right, and *LL* or *RR* for being outside of the boat lane to the left or right, respectively. The distance from the beach is transmitted in hundreds of yards as a single or double numeral. For instance, 1 equals 100 yards; 11 equals 1,100 yards.

Transmit the letter T followed by two digits to indicate the time, in minutes, of the grid position. Given the time of the position, the wave commander knows how early or late he or she is once the position is plotted. Knowledge of grid position time is important because, depending on the proficiency of the control team, receipt of the position can be up to 2 minutes after actual time.

If necessary to order a speedup or slowdown, the group SS or TT is sent, respectively.

If necessary to order a course change, a vector in tens of degrees indicating direction left or right is sent. For instance, to vector 30 degrees to the right, the group V3R is sent. Direction of the vector should always be included, because waves are not necessarily always heading for the beach but may be under control seaward towards the rendezvous area.

The group BS BS is an order to go to BATTLE SPEED.

If needed, the group TA indicates an order to turn away.

The following are examples of grid posits sent visually:

SIGNAL	MEANING
4GPL4OT32	Wave four grid posit is in the left portion of the boat lane 4,000 yards from the beach at time 32.
2GPR32T47SS	Wave two grid posit is in the right portion of the boat lane 3,200 yards from the beach at time 47 and is to speed up.
1GPLL29T52V2R	Wave one grid posit is outside of the boat lane to the left 2,900 yards from the beach at time 52 and is ordered to vector 20 degrees to the right.
3GPC20T17TT	Wave three grid posit is in the center of the boat lane 2,000 yards from the beach at time 17 and is ordered to slow down.

Upon touchdown of the first boat/vehicle of each wave, the signal TD TD TD is sent to the control ship. Remember, its going to be very difficult at times to transmit back or receive from the control ship; you must be proficient and get the job done. Visual communication is a very important part of an amphibious assault, so be prepared to do your best.

QUIET LANDING PROCEDURE

LEARNING OBJECTIVE: Explain the method of control for quiet landing, including visual signals, radio circuit, and manning requirements.

Visual signaling (flashing light, flaghoist, and/or semaphore) will be used as the primary means of controlling the movement of surface craft during the initial assault portion of a quiet landing. Radio circuits normally used in controlling the ship-to-shore movement should be checked out before the assault, subject to emission control (EMCON) policy. These radio circuits should be guarded and should be used only when all other means of communicating with surface assault waves have failed and when it is necessary to correct or alter the movement of an assault wave.

It is imperative that experienced Signalmen be embarked in control boating. They must watch the control ship constantly and must be capable of receiving at the rate of eight words per minute. Since embarked craft (LCUs and LCMs) do not normally include Signalmen in deploying boat crews, host ships should ensure that a Signalsman is assigned to embarked craft for assault operations.

PCS will transmit a vector and speed signal to each wave at 1-minute intervals once the wave has been dispatched from the LOD. The signal will be in three parts: wave identification, vector, and speed. Identification of the wave is signaled by the corresponding numeral. Vector direction is indicated by flashing ROMEO for right and LIMA for left. The amount of vector is indicated by the multiple letters, each representing 10°; for example, R indicates vector right 10°, and RRR indicates to vector right 30°. If vectoring is not necessary, the letter CHARLIE is signaled. Speed orders will be signaled by numerals indicating

speed desired. For example, 7 indicates 7 knots. BS is indicated by repeating the letter BRAVO three times. Examples of quiet landing signals follow:

SIGNAL	MEANING
3RR5	Wave three, vector right 20°; make 5 knots
5C5	Wave five, maintain course; make 5 knots
2L3	Wave two, vector left 10°; make 3 knots
1CBBB	Wave one, maintain course; make battle speed

AFLOAT SALVAGE OPERATIONS

LEARNING OBJECTIVE: Explain the purpose of the afloat salvage operation and the craft involved in the operation.

During a ship-to-shore surface assault on a hostile beach, a certain number of casualties among the assault craft are inevitable. The mission of the salvage organization is to keep boat lanes and beachheads clear of disabled assault craft so that movement to the beach is maintained.

CRAFT INVOLVED IN SALVAGE OPERATIONS

A heavy salvage boat is normally an LCM converted as stated in BOATALT 19C, dated 05/10/63, and is stationed outside the surf zone but close enough

to maintain good visibility of the beach and its approaches.

A light salvage boat is normally an LCPL and is stationed seaward of the surf zone along the boat lanes as required.

Salvage teams should consist of personnel from one ship trained as a team to maintain consistency. Personnel for salvage teams should be assigned as shown in figure 12-15.

NOTE

One team member must be a qualified search and rescue (SAR) swimmer.

The boat equipage for the heavy salvage and the ABGC/light salvage boats is detailed in NWP 22-3.

DISPATCHING VESSELS

The visual signals used to dispatch the boat waves from the LOD are displayed by both the primary and secondary control vessels. Every wave commander has a radio in the boat, and the foregoing signals are paralleled by radio signals.

Wave commanders control their boats by means of hand signals, as shown in figure 12-16.

At night, lighted wands or flashlights are used. The positions are the same as for the day signals. Lights are turned on when the hands are in the starting positions and turned off when the signals have been

HEAVY SALVAGE BOAT	LIGHT SALVAGE BOAT
1 - Salvage officer	1 - BM2/BM3 (salvage rigger)
1 - BMC/BM1 (salvage rigger)	1 - SM3/SMSN
1 - EN1/EN2	1 - HT2/HT3
1 - HT2/HT3	1 - RM3/RMSN
1 - RM3/RMSN	1 - SN
1 - SM3/SMSN	
1 - HM3/HMSN	
1 - SN	

Figure 12-15.—Salvage team personnel.

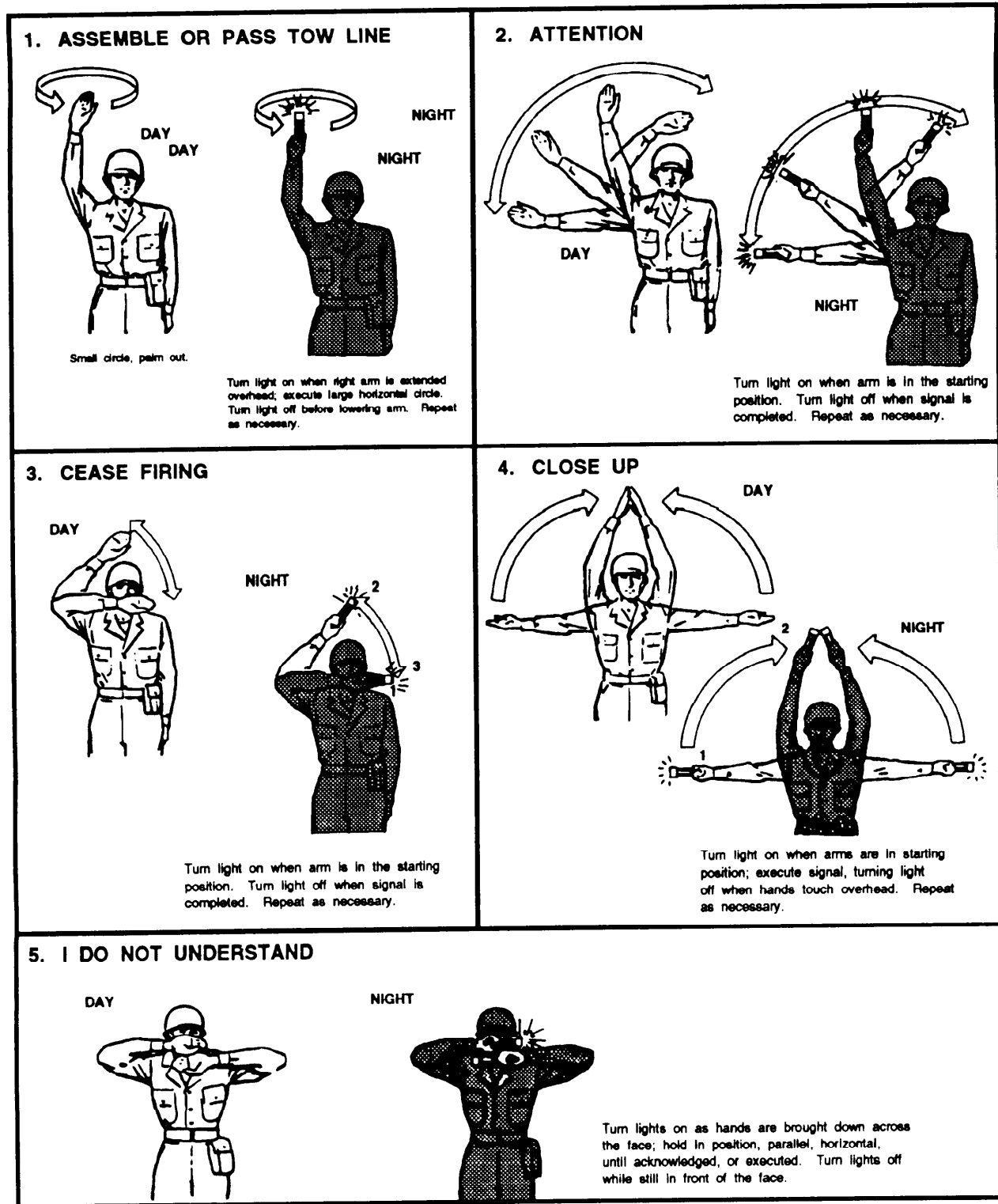

73NP0090

Figure 12-16.—Arm and hand control signals—landing craft and amphibious vehicles.

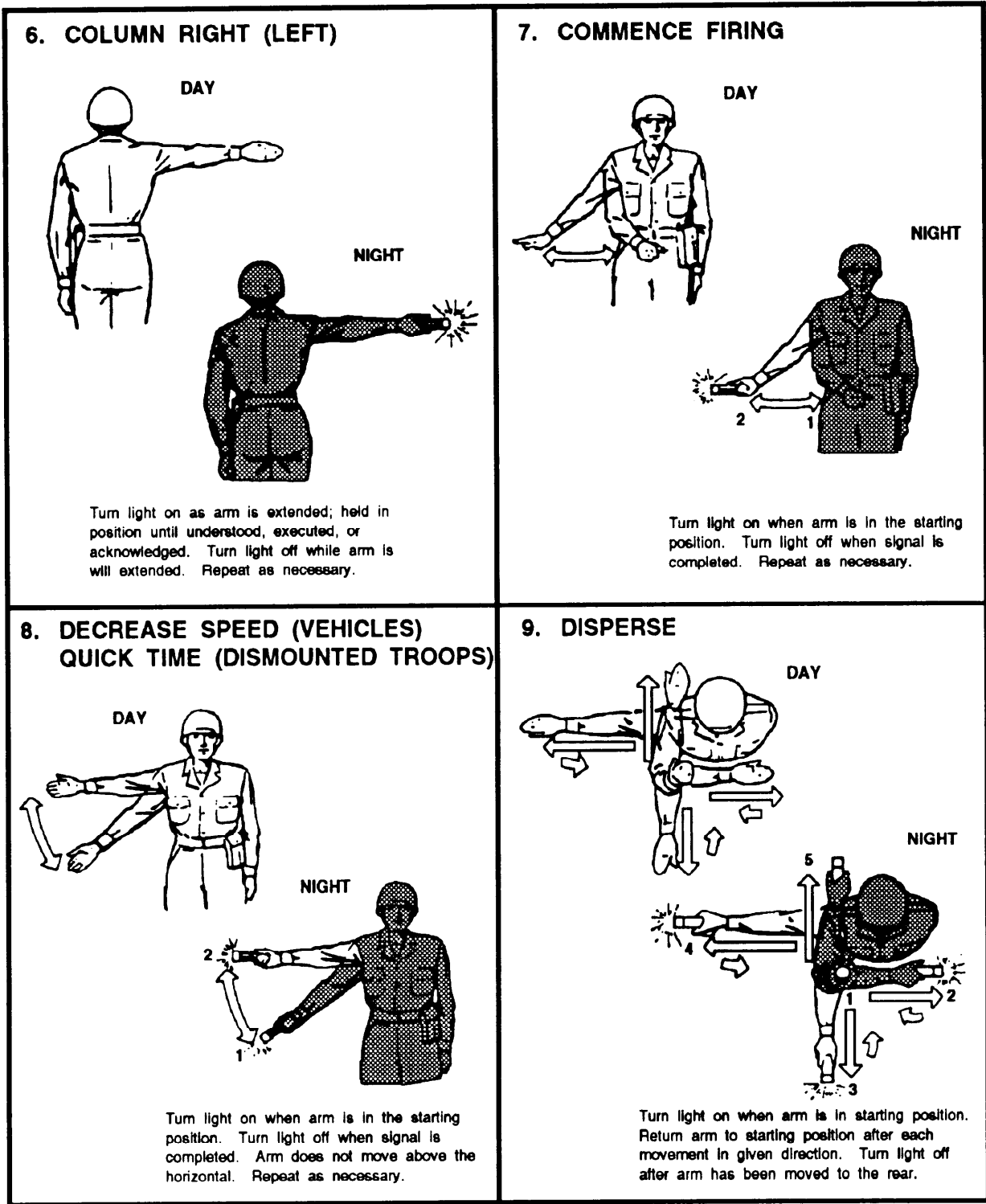

73NP0091

Figure 12-16.—Arm and hand control signals—landing craft and amphibious vehicles—Continued.

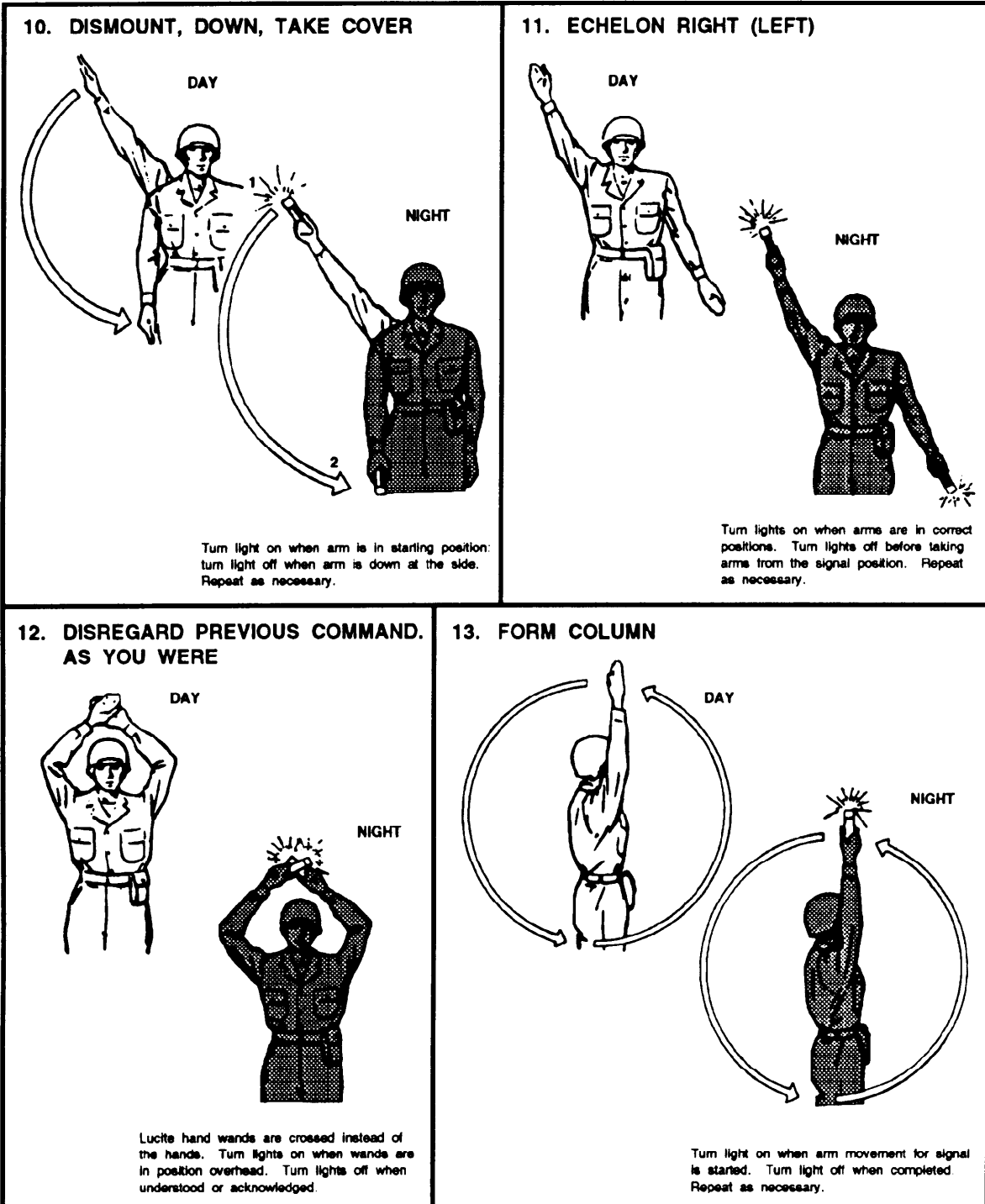

73NP0092

Figure 12-16.—Arm and hand control signals—landing craft and amphibious vehicles—Continued.

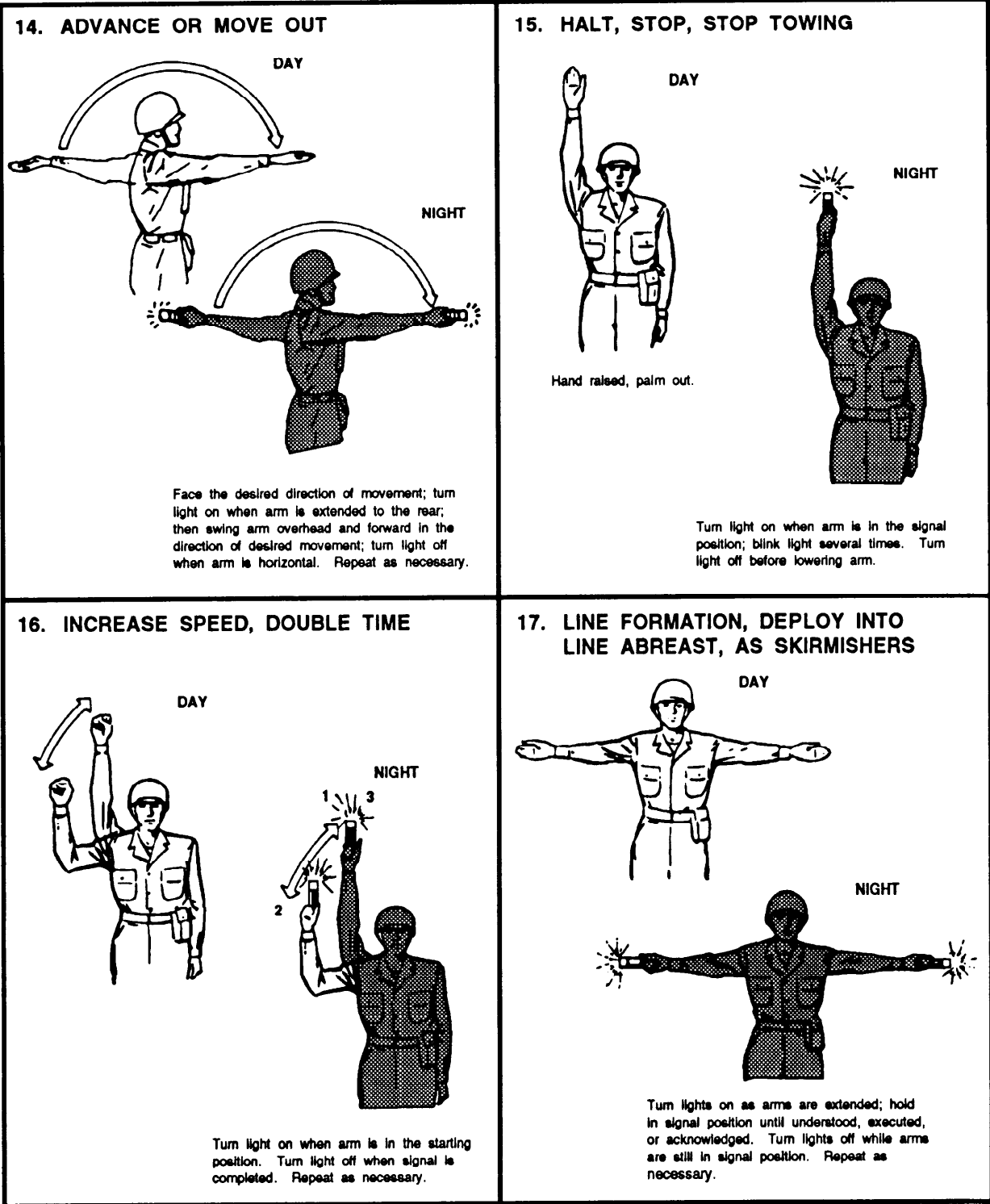

73NP0093

Figure 12-16.—Arm and hand control signals—landing craft and amphibious vehicles—Continued.

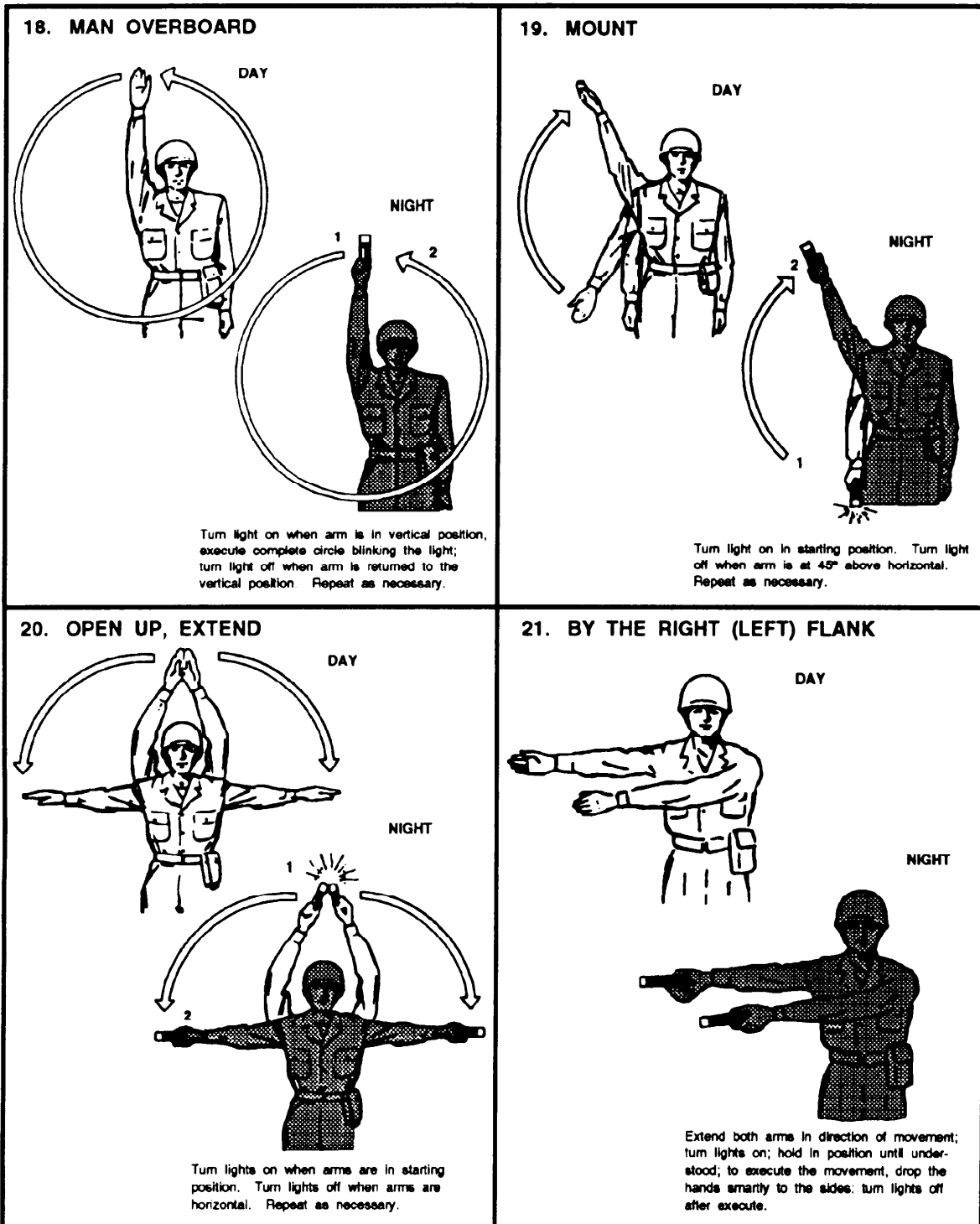

73NP0094

Figure 12-16.—Arm and band control signals—landing craft and amphibious vehicles—Continued.

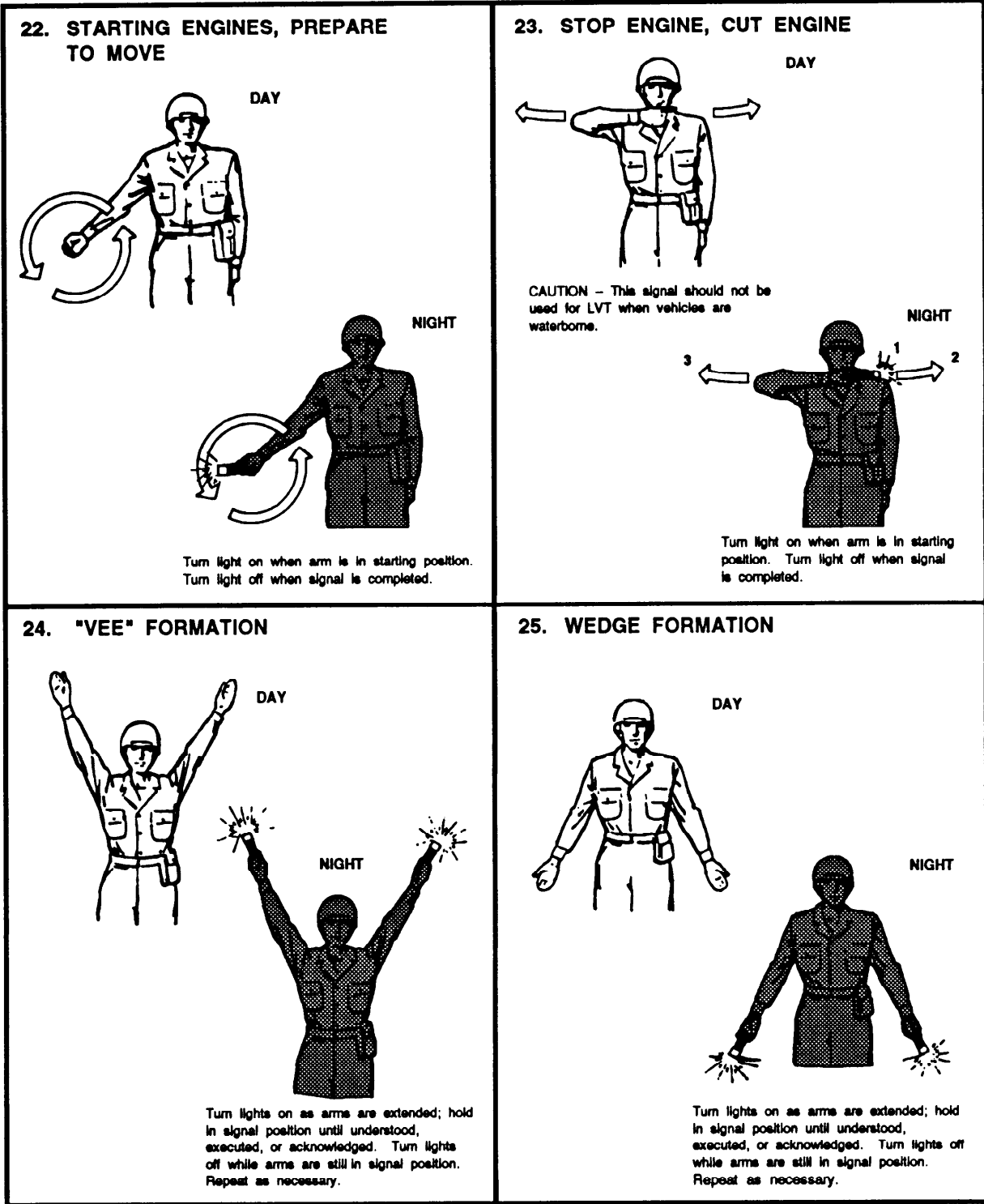

73NP0095

Figure 12-16.—Arm and hand control signals—landing craft and amphibious vehicles—Continued.

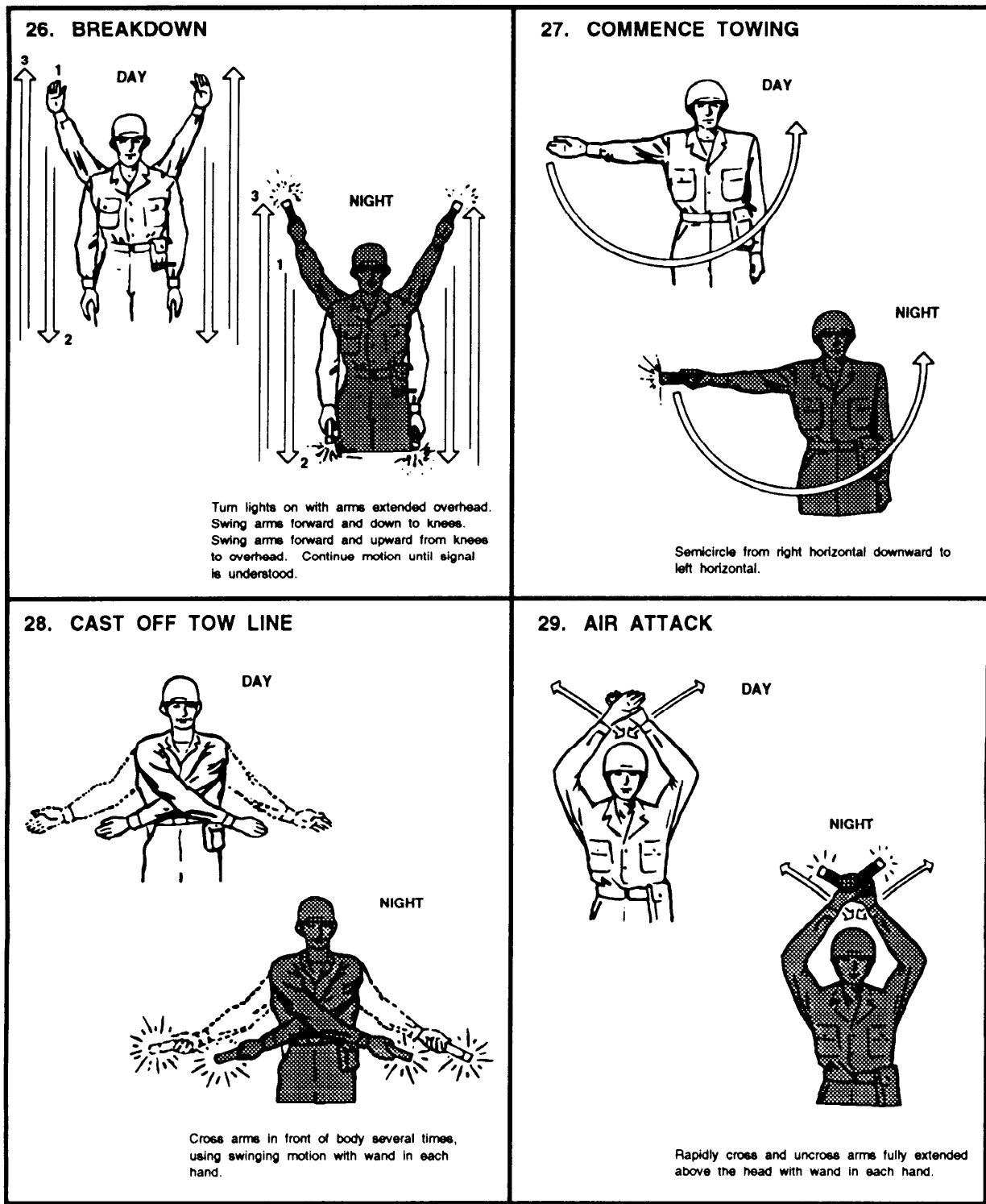

73NP0096

Figure 12-16.—Arm and hand control signals—landing craft and amphibious vehicles—Continued.

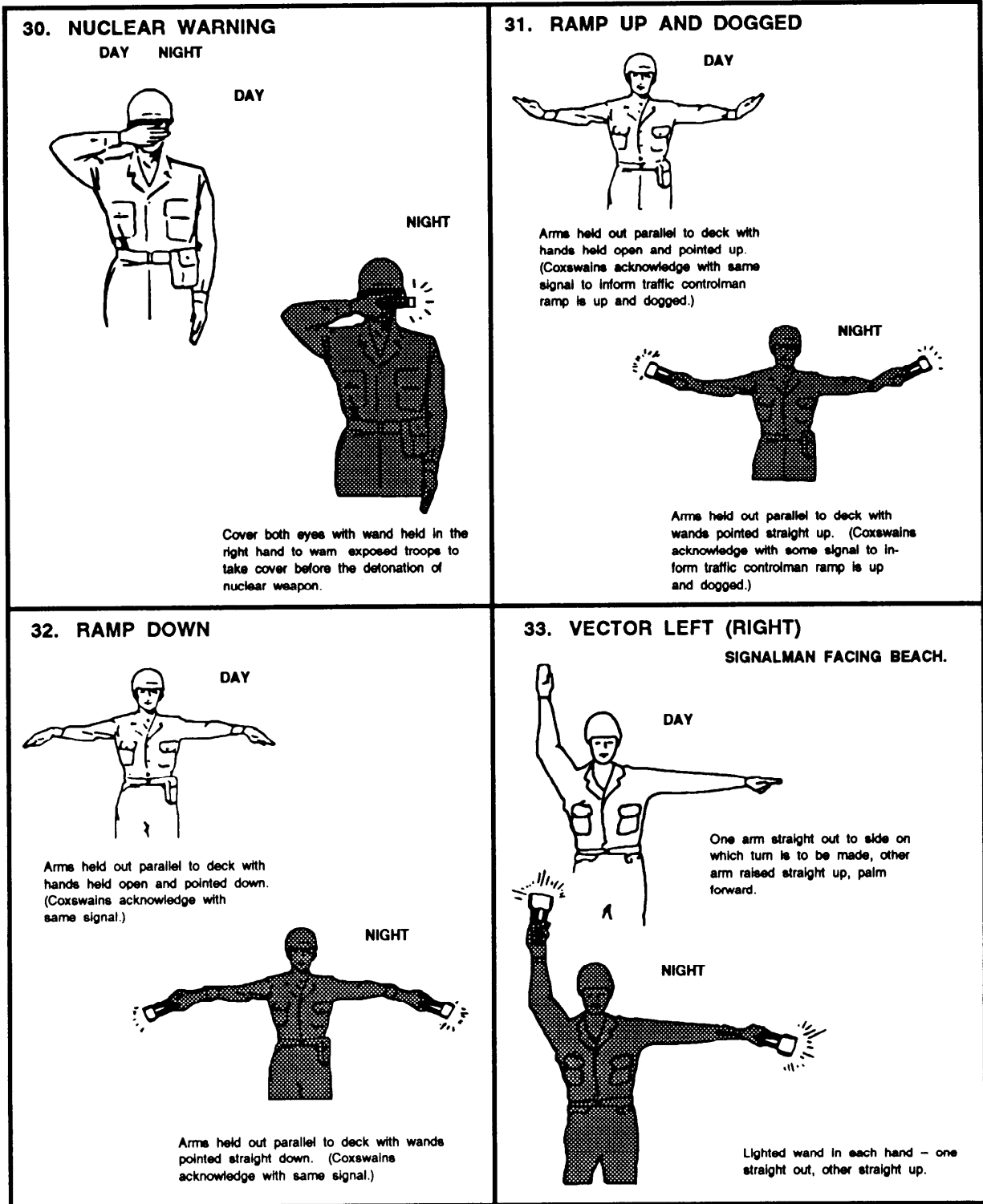

73NP0097

Figure 12-16.—Arm and hand control signals—landing craft and amphibious vehicles—Continued.

completed. At the end of start and stop signals the light is blinked several times. Night signals are repeated as necessary. The formations used are illustrated in figure 12-17. Assault boat coxswains should know all of these signals and formations. Those signals concerning starting, stopping, breakdown, towing, and so on, might also prove useful to any coxswain in the event of an emergency.

The naval beach party is landed early in the assault. When they reach the beach, they proceed with their duties of marking channels and hazards to navigation, establishing communications, improving beaches, and so forth.

After a boat unloads on orders from the beach party, it retracts past the surf line and proceeds to a designated flank of the boat lane. Keeping clear of the boat lane, it proceeds to seaward and reports to the control vessel for further orders.

GENERAL UNLOADING PHASE

During the general unloading phase, loaded boats do not maintain a formation on the trip to the beach, although several of them may be required to move as a unit. On the way to the beach they must stop for orders at the PCS and the BGC's boat.

The type of cargo in a boat is indicated by the color of special flags flown. Red denotes bulk cargo, which needs manpower for unloading; yellow shows the load is such that a prime mover is required; blue denotes self-propelled cargo; and a red burgee shows the boat is a bowser (fuel) boat. A green flag shows a boat belongs to a floating dump, and a numeral flag may be flown under it to indicate the type of cargo carried.

SUMMARY

In this chapter, you have learned the general concept of an amphibious operation and the different

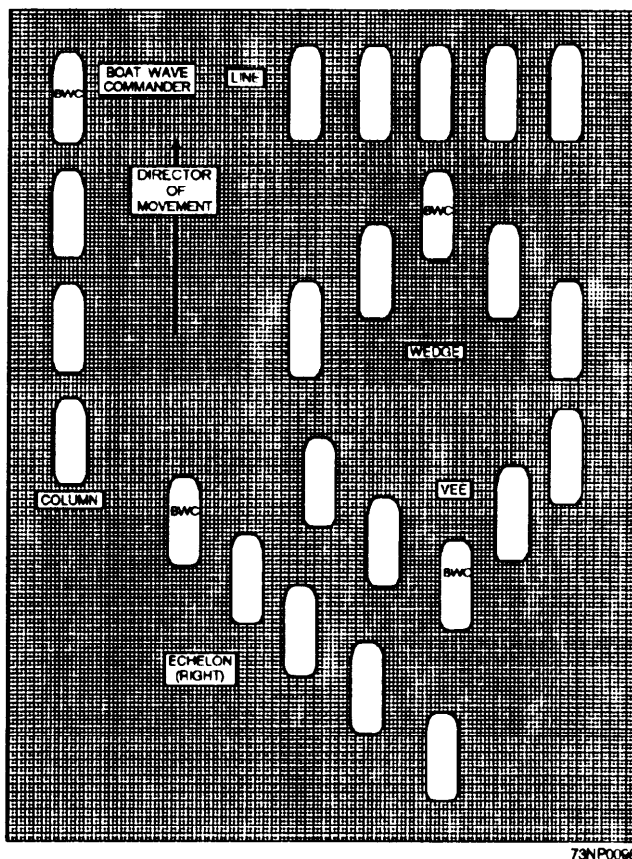

Figure 12-17.—Boat formations.

ships, boats, and landing craft involved. You have learned about standard flags and markers, control areas, and debarkations. You also have learned to transmit grid position both by radio and visually and the procedures for dispatching waves to the LOD during daylight and nighttime. You have learned the duties of the different personnel associated with an amphibious landing. Although this chapter has a lot of information to learn about amphibious landings, your best source of information is NWP 22-3.

AIRCRAFT AND SHIP IDENTIFICATION

As you learned in previous chapters, lookout duties are some of your most important duties. As a part of your lookout duties you must be able to identify aircraft, ships and, on occasion, submarines. This chapter covers the basics in identification procedures.

AIRCRAFT IDENTIFICATION

LEARNING OBJECTIVE: Explain the procedures for the identification of aircraft, including aircraft type, aircraft measurement, and other identification aids.

Aircraft identification is a very important asset to the Signalman on watch, so you must learn as much as you can to assist in the identification of aircraft.

Although this chapter will familiarize you with the most frequently used aircraft, you should guard against making positive identification hastily. The identity of every aircraft must be checked by even the most knowledgeable interpreter. You should study unidentified aircraft carefully, using all available references on recognition and identification. The dimensions and characteristics of all known aircraft are available from many sources, including *Aircraft of the World*, *Aircraft Armament Handbook (Characteristics and Performance) Eurasian Communist Countries*, and probably the most popular, *Jane's All the World's Aircraft*, just to name a few.

AIRCRAFT TYPES

When the scale or quality of imagery makes it difficult to identify the type of aircraft (jet or prop), you must rely on distinguishing characteristics to aid in identification. A single-engine jet, as opposed to a single-engine propeller-driven aircraft (fig. 13-1), has one or more of the following recognition characteristics:

- The wings are farther back from the nose.
- The widest part of the fuselage is near the center.
- The wings are usually angled back, inboard to outboard.

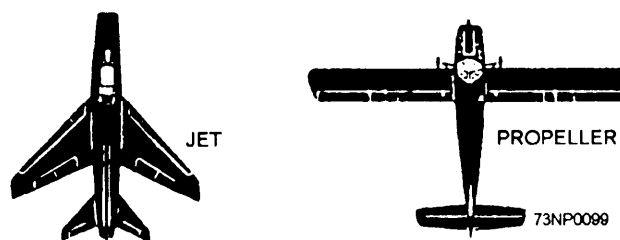

Figure 13-1.—Single-engine aircraft recognition characteristics.

- The wings usually have less surface area.
- The distance from the wings to the horizontal stabilizer is less than that from the wings to the nose.

There are fewer visible differences between multiengine jet aircraft and multiengine propeller aircraft than between the single-engine types. However, the twin and multiengine jets (fig. 13-2) usually have one or more of the following characteristics.

- The wings are usually angled back, inboard to outboard.
- The engines are usually suspended from the wings.
- The wings have less surface area.

AIRCRAFT MEASUREMENTS

The two major characteristics in aircraft interpretation are the size of the image and the shape of various components. Accurate measurements are vital because the general appearance of certain aircraft often may be so similar that only the difference in

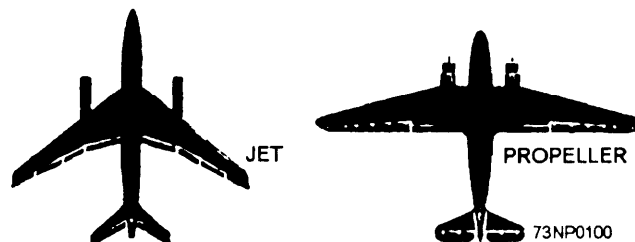

Figure 13-2.—Twin and multiengine aircraft recognition characteristics.

wingspan provides the final clue for identification (fig. 13-3).

IDENTIFICATION AIDS

The study of aircraft shadows can often lead to identification. Since shadows tend to overemphasize aircraft features, it is sometimes better to study the shadow rather than the aircraft itself. Wing shadows, however, are misleading because of their relation to the direction of light, upsweep of the wings or dihedral, and the ground angle of the aircraft. Nose shadows are helpful; even transparent noses will cast a shadow where there is rear light. Under the conditions of rear lighting, the shadow of the nose, engine, nacelles, and gun turrets are well defined. Fin and rudder shadows also should be carefully studied since they provide important recognition features.

Wing Characteristics

Because of their size and shape, the wings of aircraft are perhaps the easiest aircraft component to identify. The wings constitute the most important identification feature on vertical imagery. The identification features of the wings are their overall

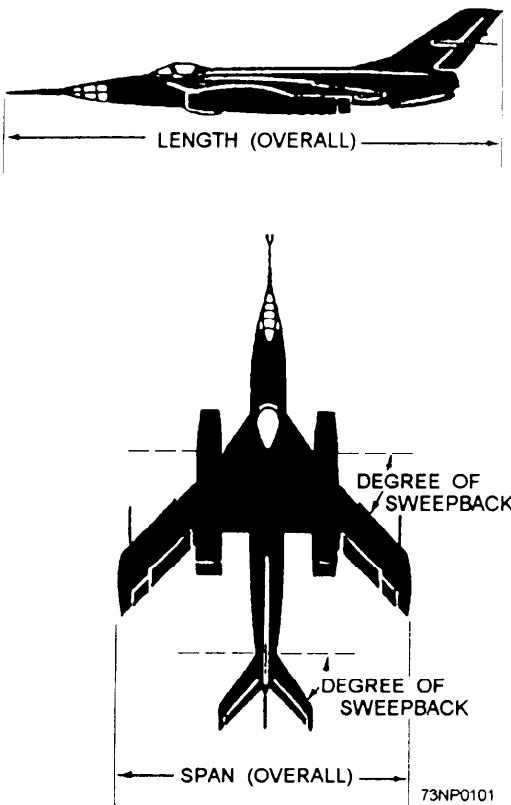

Figure 13-3.—Aircraft measurements.

shape (fig. 13-4) and the shape of their tips (fig. 13-5). Wing shapes are generally classified according to their taper, amount of sweepback, design of leading edge, symmetry, or delta configuration, as shown in figure 13-5. Wing sweepback is measured as shown in figure 13-3. Recent technological advances have developed a unique ultraforward-swept wing (fig. 13-6), which may lead to a new line of super-fast tactical fighters with enhanced maneuverability.

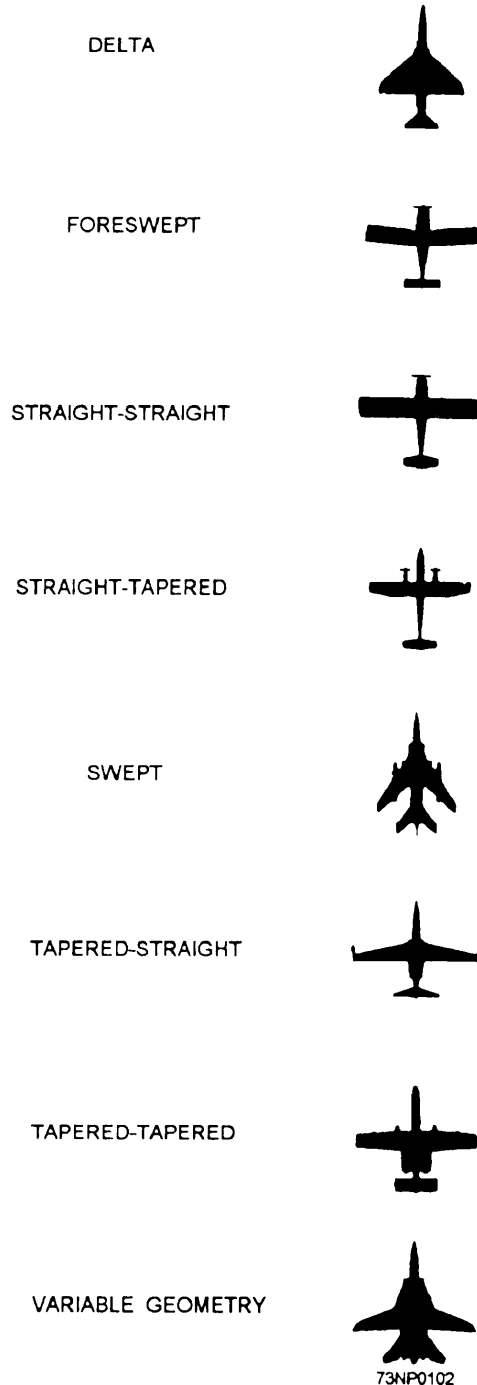

Figure 13-4.—Wing shapes.

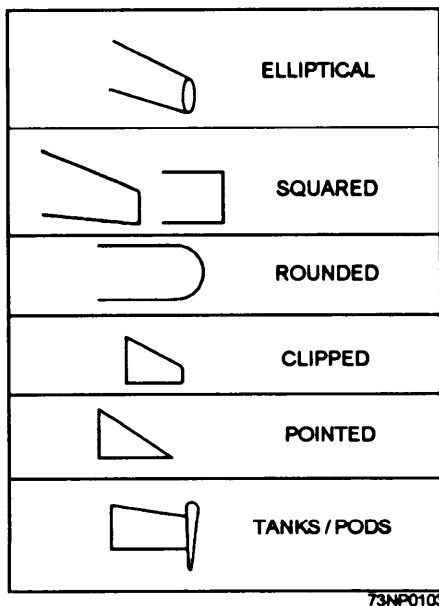

Figure 13-5.—Wingtip shapes

Engine Criteria

The methods of determining engine type (jet or prop) were previously discussed under Aircraft Types. Identification of the type, number, and location of engines, used in conjunction with two keys, will help you identify aircraft. For example, the Soviet TU-95 BEAR is the only turboprop-powered heavy bomber in the world. The wing mounts four turboprop engines with coaxial, contrarotating propellers. As shown in figure 13-7, all of the engine nacelles protrude forward of the wing, but only the inboard engines have landing gear nacelles that extend aft of the wing.

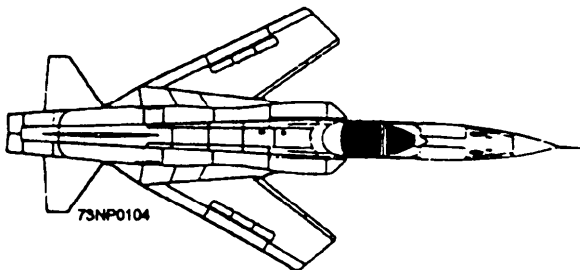

Figure 13-6.—Ultraforward-swept wing.

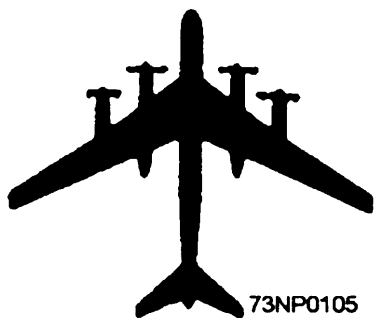

Figure 13-7.—Silhouette of the TU-95 BEAR

Fuselage Types

Use of the fuselage in aircraft recognition is primarily restricted to its size and shape (fig. 13-8) and the shape of the nose section (fig. 13-9). Nose sections may also be glazed or have a shock cone. In some jet models, the air intake may be located if the imagery is of satisfactory quality. Seaplanes have very distinct features in their fuselage design, but such design characteristics are often difficult to determine on vertical imagery. Shadows can be of great help in this regard.

Tail Surfaces

Recognition characteristics of tail surfaces are generally the shape and location of the horizontal stabilizer, since the vertical stabilizer is difficult to analyze in vertical imagery. The basic features recognizable in the horizontal stabilizer are very similar to those used for identifying wing surfaces: shapes and tip shapes.

Another feature that can be of help is the position of the horizontal stabilizer. For example, the horizontal stabilizer may be located (1) on the axis (centerline) of the fuselage, (2) below the centerline, (3) above the centerline, or (4) on the vertical stabilizer, above the fuselage. (See fig. 13-10.)

HELICOPTER IDENTIFICATION

Helicopters are among the most easily recognizable military equipment. The term *rotary-wing aircraft* includes those aircraft that depend primarily on lift from their rotary-propulsion systems. Also, the maneuverability and the forward thrust are controlled either by the rotor system or by an auxiliary engine system. For our discussion, aircraft meeting this criteria are called helicopters.

The primary recognition features used in helicopter identification are the rotor system and the number of rotor blades (never less than two). After determining the type of rotor system and the number of blades, you should refer to the appropriate aircraft book for final determination of the model. *Military Aircraft of the World* is a good source.

Other factors that will assist you in helicopter identification are the shapes of the fuselage and tail boom and the presence or absence of wings.

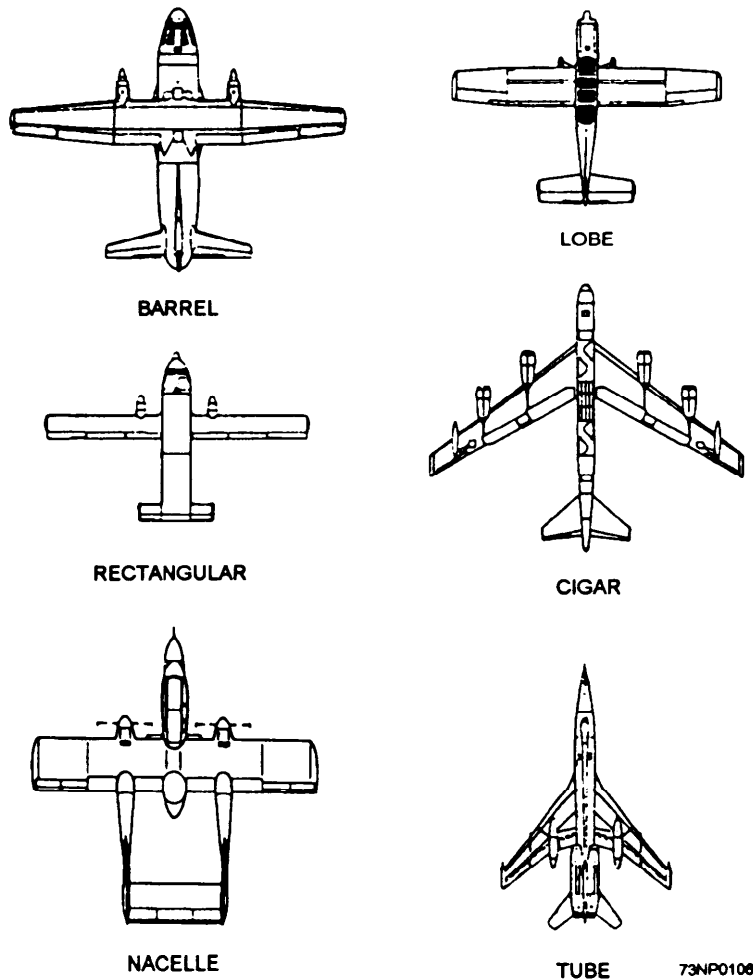

Figure 13-8.—Fuselage shapes

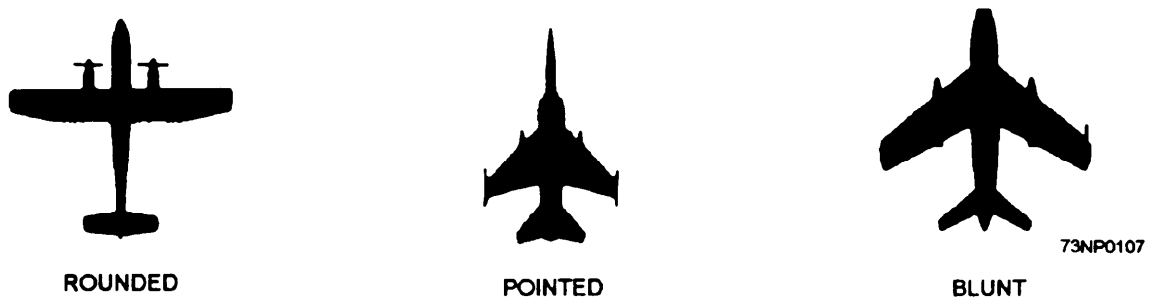

Figure 13-9.—Nose shapes.

Figure 13-11 shows these and other less important recognition features.

AIRCRAFT IDENTIFICATION CONCLUSION

The different types of aircraft presently in use by military and naval powers are so numerous that only an expert can be expected to know and recognize them all. Bombers, fighters, fighter-bombers, and

reconnaissance planes may be propeller-driven or jet; single- or multiengine; straight-wing or delta-wing; or a combination of these.

Instruction in identification of aircraft should consist primarily of classroom lectures, slides, and motion pictures, together with on-the-job instruction when aircraft are operating in the ship's vicinity.

Determination of the friendly or unfriendly character of aircraft is a prime mission of the ship's

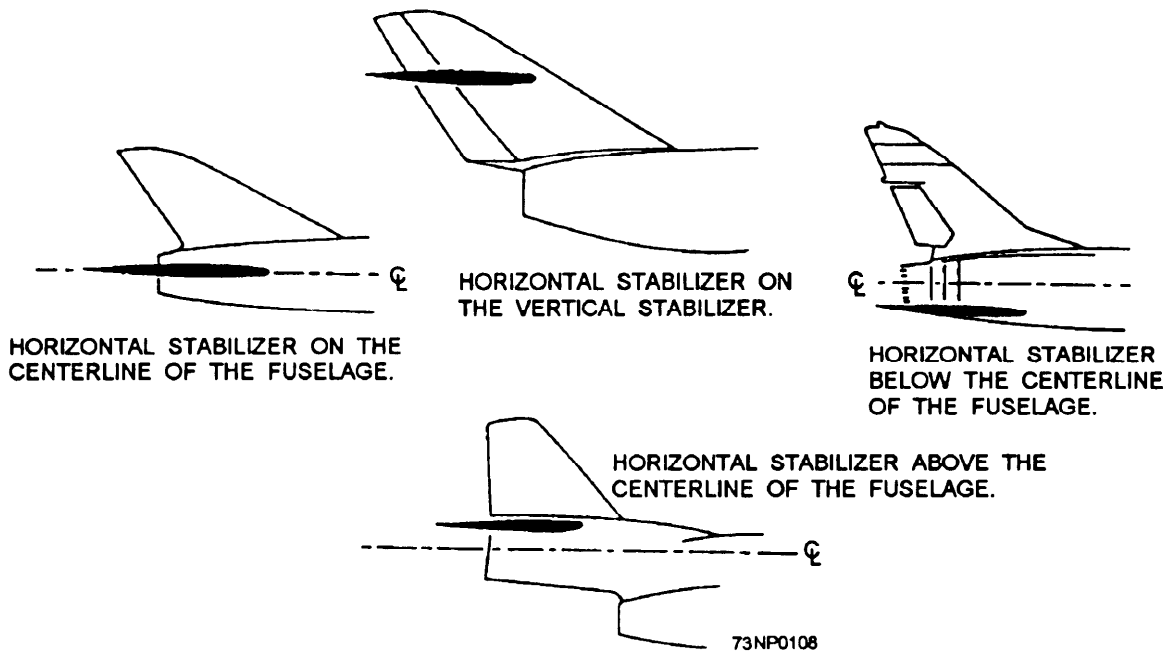

Figure 13-10.—Position of the horizontal stabilizer.

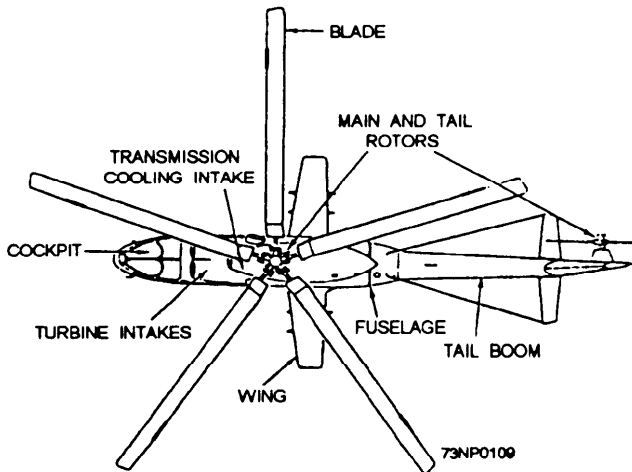

Figure 13-11.—Helo recognition features

installed IFF (identification friend or foe) system, which can be used to interrogate aircraft long before the aircraft is in visual range. Exact names and designations of aircraft not only may be hard to get but also may prove unimportant. Personnel should be taught to distinguish between the various classes of aircraft: bombers, fighters, transports, and so forth.

SHIP IDENTIFICATION

LEARNING OBJECTIVE: Explain the procedures for identifying naval ships, including combatants, auxiliaries, and amphibious ships.

Ship identification requires the same type of instruction as for aircraft identification. It is possible here to place more emphasis on on-the-job training, because wide variations in ship types are encountered in normal operations on the high seas.

Recognizing ships at sea is as important as recognizing airborne aircraft. Since surface vessels travel in two dimensions and are slower than aircraft, they are much easier to identify visually. Ships normally should be identified while they are still distant enough to present only a silhouette to the observer. The type/classes of ships should be determined from their silhouette long before their hull numbers or names can be distinguished. The first determination to be made is whether the vessel is a naval or merchant ship.

In general, naval ships do not appear as bulky as merchant ships. The naval ships have flowing lines and usually have less deckhouse and superstructure. Virtually all maritime powers paint their naval ships some shade of gray or blue-gray that blends easily with the ocean background. When close enough for colors to be distinguishable, merchant ships can easily be identified because they are painted in a variety of colors. During peacetime another indication of naval-merchant character of a vessel is the presence of visible weapons. The absence of guns may have little significance, but their presence almost certainly indicates a naval vessel. Merchant ship identification will be covered later in this chapter.

SURFACE SHIPS

There are many types of surface ships, such as combatants, auxiliary ships that support combatants, and auxiliaries called special-purpose ships (they perform specific functions), and amphibious. For example, replenishment ships and repair ships are auxiliary ships, and icebreakers and intelligence collectors are special-purpose ships. The *Glossary of Naval Ship Types* is a guide to the classification and typing of non-U.S. Navy ships and craft. *Jane's Fighting Ships* is also a good reference for the identification of non-U.S. and U.S. Navy ships.

COMBATANTS

The purpose of combatants is to engage enemy ships in naval warfare. Combatants are assigned various missions, depending primarily on their armament and secondarily on characteristics such as size, speed, and maneuverability. The following ships fall into the combatant category: aircraft carriers, battleships, cruisers, destroyers, and frigates.

Aircraft Carriers

Aircraft carriers (CV/CVNs) are generally the largest warships afloat and are the major offensive surface ships of the U.S. fleet. Aircraft are their chief weapons, and missions are determined by the type of aircraft carried. The high freeboard and expansive, uncluttered flight deck give the aircraft carrier a distinctive appearance. On many carriers, the superstructure or island (usually offset to the starboard side of the flight deck) is the only prominent feature of the flight deck. Figure 13-12 shows examples of different classes of aircraft carriers.

Cruisers

Cruisers are multimission anti-air (AAW), antisubmarine (ASW), antisurface (ASUW) surface combatants capable of supporting carriers, battle groups, and amphibious forces or of operating independently. They usually measure about 550 to 700 feet in length and displace from 7,000 to 15,000 tons. The trend in modern cruisers features tall, solid towers amidships instead of separate pole masts and cylindrical stacks. These midships towers often incorporate masts, stacks, and other superstructure elements in various combinations. See figure 13-13 for examples of cruisers.

The bow and forward superstructure of the modern helicopter cruiser (fig. 13-14) resemble those found on cruiser warships. The stern section consists of level, uncluttered deck space used for launching and landing operations. The bow section contains weapons and electronics equipment. The primary mission of the helicopter cruiser is ASUW.

Destroyers

Destroyers (DD/DDGs) are versatile, multipurpose warships of moderate size (3,000 to 8,000 tons and 400 to 600 feet long) and are equipped to perform ASW operations, while guided-missile destroyers are multimission and perform AAW and ASUW operations. Modern U.S. destroyers and guided-missile destroyers are called upon to perform primarily in a battle force combatant role. They operate in support of carrier or battleship battle groups, surface action groups, amphibious groups, and replenishment groups. Destroyers typically have two large stacks with considerable rake, light mast, superimposed gun mounts forward, ASW gear aft, and torpedo tubes topside. Figure 13-15 shows examples of destroyers.

Frigates

Frigates (FF/FFGs) fall into the general category of smaller major combatants whose offensive weapons and sensors are used for a particular warfare role, such as screening support forces and convoys. Frigates range in length from 300 to 400 feet and displace 1,500 to 4,000 tons. They usually have only one gun mount forward, while the aft armament often consists of ASW and/or AAW weaponry. A helicopter pad frequently is present in the stern area. (See fig. 13-16.)

MINOR COMBATANTS

There are numerous types of minor combatants, such as minesweepers and patrol boats. Many countries that either do not require or cannot afford larger ships use these smaller combatants for river and coastal defense patrol.

Many of the newer patrol boats are armed with missiles, and some are equipped with hydrofoils, or air cushions, which greatly increase their firepower, speed, and maneuverability. Figure 13-17 is an example of a minor combatant.

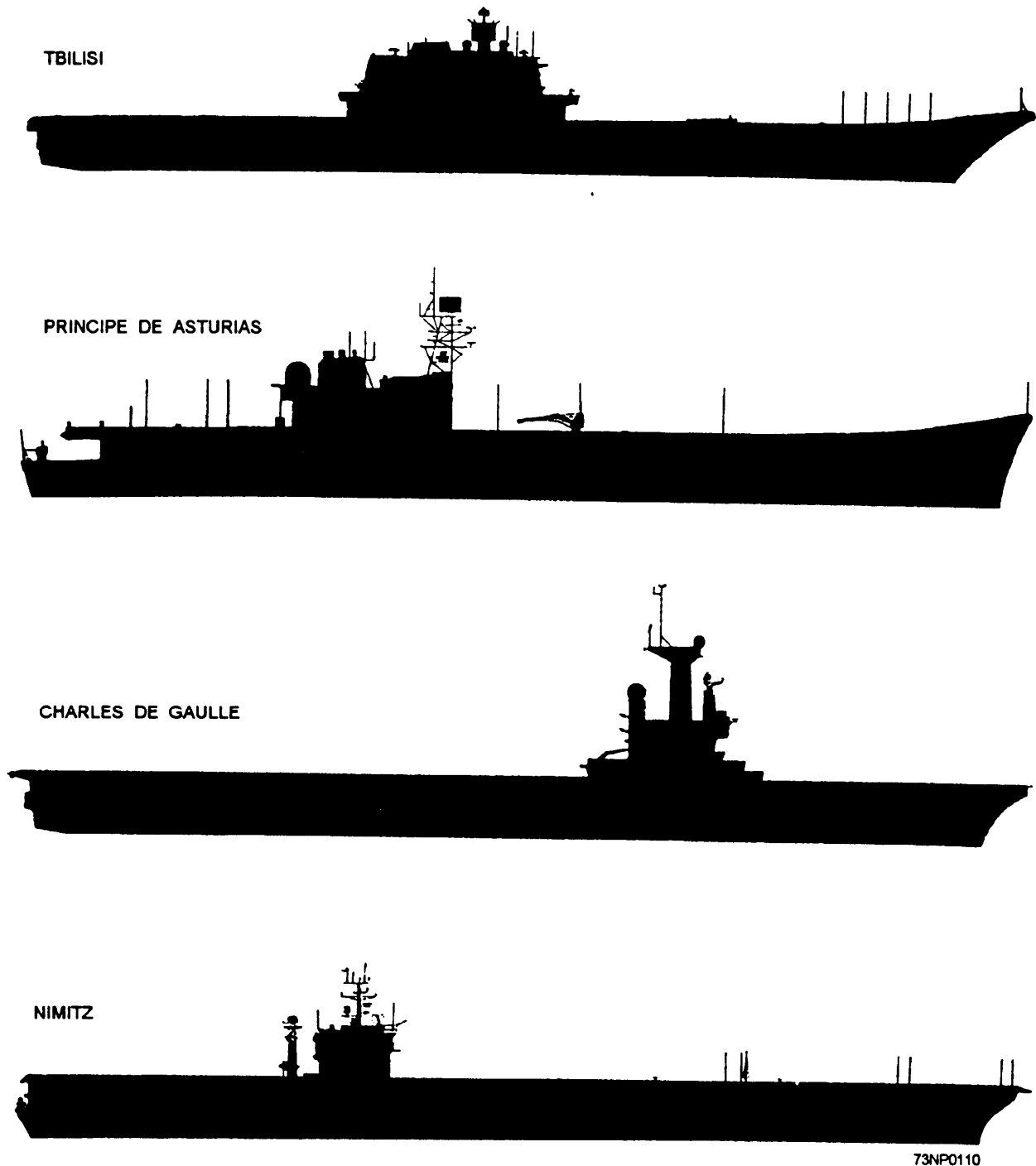

73NP0110

Figure 13-12.—Classes of aircraft carriers.

AMPHIBIOUS SHIPS

Amphibious ships are designed to move combat personnel and equipment ashore. With the exception of shore bombardment, the armament of amphibious ships is usually intended for defensive purposes only. We will discuss a few of the amphibious ships in the following paragraphs.

The largest amphibious ships (LHDs, LHAs) can be identified by the large boxlike superstructure. They measure from 800 to 850 feet and displace 28,000 to 40,000 tons. Amphibious command ships (LCC) can be identified by their visible electronic gear; they measure 620 feet and displace 19,000 tons. Amphibious transport docks (LPDs) can be identified by their having weaponry forward and a flight deck

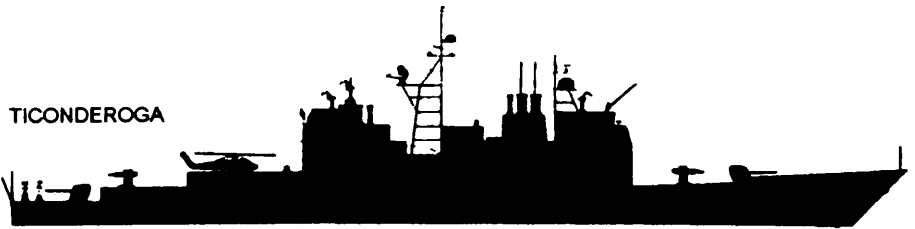

73NP0111

Figure 13-13.—Classes of cruisers.

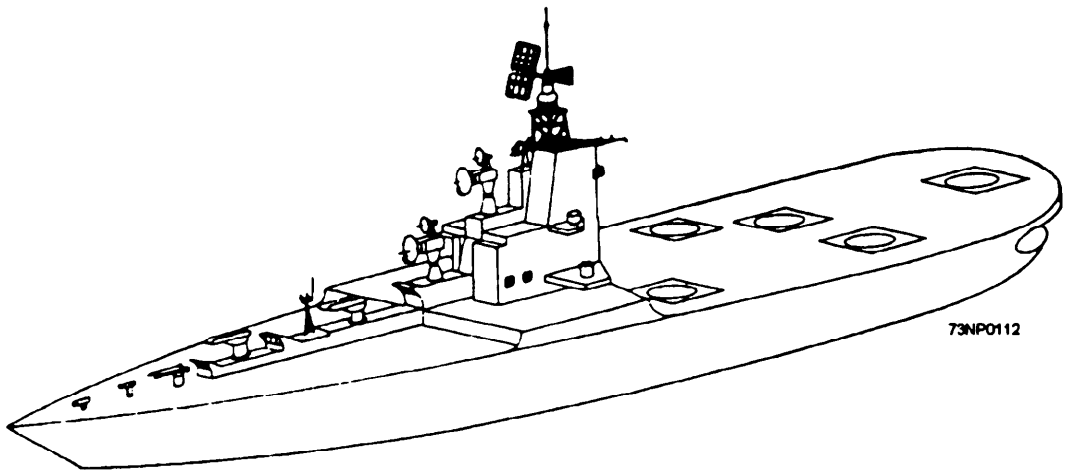

73NP0112

Figure 13-14.—Helicopter cruiser.

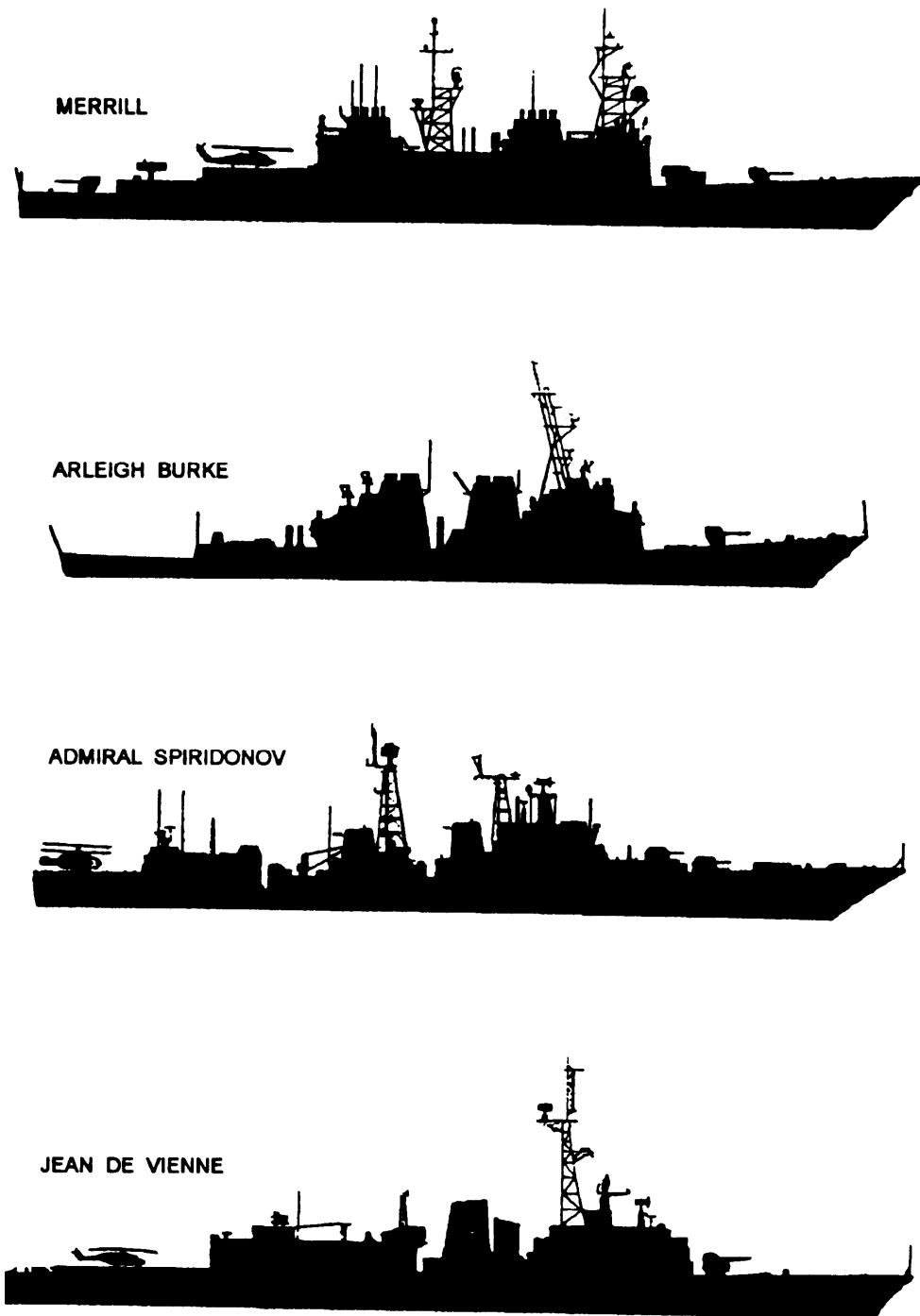

73NP0113

Figure 13-15.—Classes of destroyers.

aft. They include two helicopter landing pads, a fold-down ramp gate at the stern, and topside cranes and other machinery. They measure 570 feet and displace 17,000 tons. Small amphibious ships (LSTs) are characterized by the ramp extending from the forward part of the ship. They measure about 520 feet and displace 8,450 tons. Small Soviet ships are usually characterized by a superstructure aft and a long, open

deck area forward. Figure 13-18 shows examples of amphibious ships.

AUXILIARY SHIPS

There are many types of auxiliary ships that perform various duties. They range from oilers to repair ships. They are usually lightly armed for



KONI CLASS

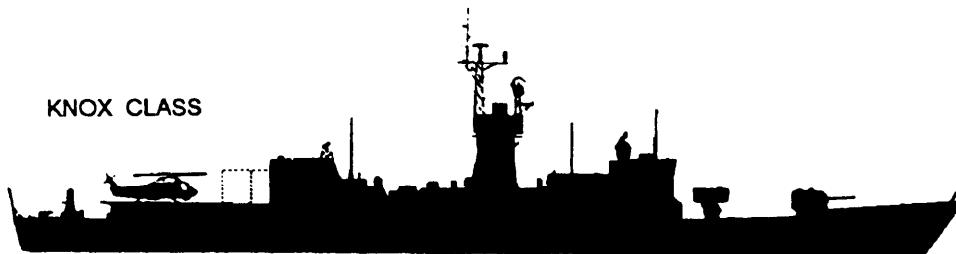

KNOX CLASS

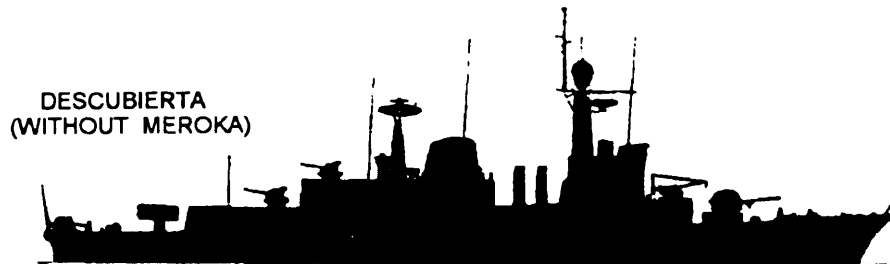

DESCUBIERTA
(WITHOUT MEROKA)

73NP0114

Figure 13-16.—Classes of frigates.

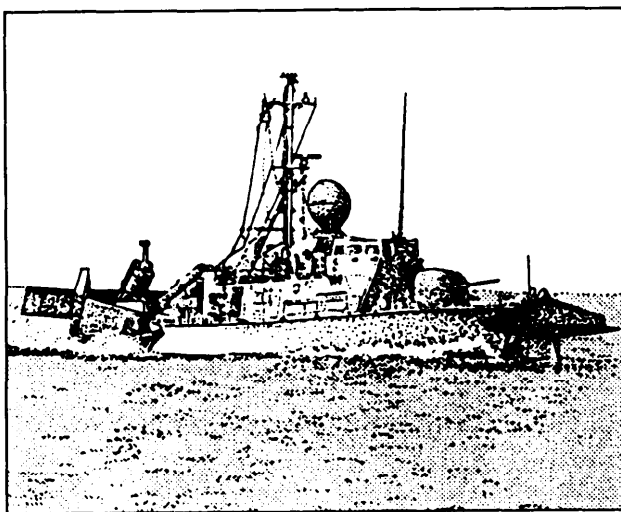

73NP0115

Figure 13-17.—Pegasus-class hydrofoil.

self-defense and rely mainly on combatants for protection. They are constructed in various sizes and configurations unique to their role. Many auxiliary

ships, especially those used for replenishment and repair, have cranes and booms on deck that are used for transferring equipment, supplies, and fuel to the fleet.

SHIP IDENTIFICATION CONCLUSION

The need for rapid and accurate identification of Soviet ships is important with the number of Soviet naval sightings throughout the world. Figure 13-19 shows the silhouettes of the most commonly sighted Soviet warships. To help you translate Russian ships' names, figure 13-20 is a transliteration table to convert the Russian alphabet into the English alphabet. You must familiarize yourself with both the silhouettes and the transliteration table to be able to identify, on sight, ships of the Soviet Navy.

IVAN ROGOV CLASS



WHIDBEY ISLAND CLASS

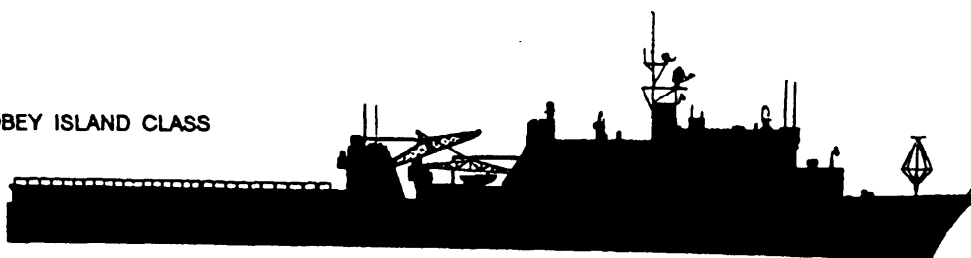

AUSTIN CLASS



IWO JIMA



WASP CLASS

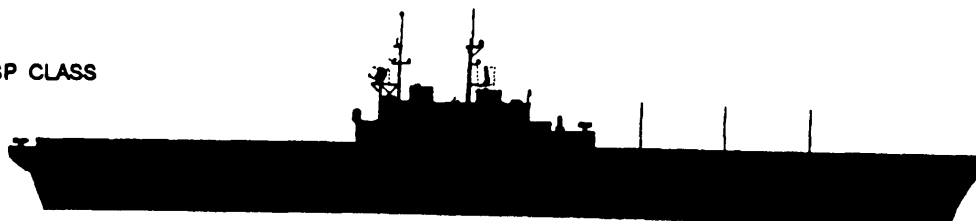

73NP0116

Figure 13-18.—Classes of amphibious ships.

AIRCRAFT CARRIER



MODIFIED KIEV (KURIL) CLASS (CVSG)

HELICOPTER CRUISER

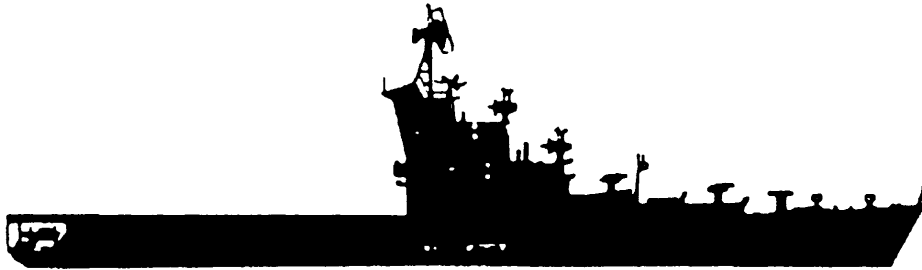

MOSKVA (MOSKVA) CLASS (CHG)

CRUISERS



KIROV CLASS (CGN)



KARA CLASS (CG)



KRESTA I CLASS (CG)



KRESTA II CLASS (CG)



SLAVA CLASS (CG)



KYNDA CLASS (CG)

73NP0117

Figure 13-19.—Recognition silhouettes of Soviet ships page 1 of 3.

DESTROYERS



SOVEREMENNY CLASS (DDG)



KILDIN CLASS (DDG)



MOD. KASHIN CLASS (DDG)



KANIN CLASS (DDG)



KOTLIN CLASS (DD)



SKORY CLASS (DD)

FRIGATES



KRIVAK CLASS (FFG)



PETYA I AND II CLASS (FFL)



RIGA CLASS (FF)



MIRKA I AND II CLASS (FFL)



GRISHA I, II, AND III, CLASS (FFL)

73NP0118

Figure 13-19.—Recognition silhouettes of Soviet ships, page 2 of 3.

INTELLIGENCE COLLECTORS (AGI'S)



PRIMORYE CLASS

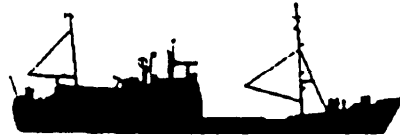

OKEAN CLASS



LENTRA CLASS

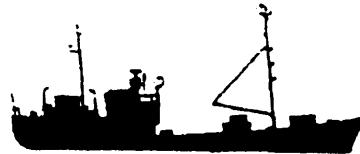

LENTRA CLASS

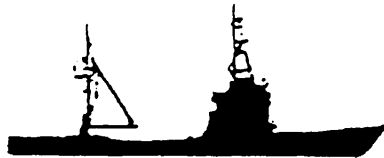

AL'PINIST CLASS



MIRNYY CLASS



MOMA CLASS



PAMIR CLASS



ZUBOV CLASS



BALZAM CLASS 73NP0119

Figure 13-19.—Recognition silhouettes of Soviet ships page 3 of 3.

CAPITAL LOWER CASE	ENGLISH TRANSLITERATION	PRONOUNCED	CAPITAL LOWER CASE	ENGLISH TRANSLITERATION	PRONOUNCED	CAPITAL LOWER CASE	ENGLISH TRANSLITERATION	PRONOUNCED
А а	A	like a in father	Л л	L	like / in well	Ц ц	TS	like ts in mats
Б б	B	like b in bell	М м	M	like m in stem	Ч ч	CH	like ch in check
В в	V	like v in vent	Н н	N	like n in pen	Ш ш	SH	like sh in shine
Г г	G	like g in get	О о	O	like o in more	Щ щ	SHCH	like sh-ch fresh cheeks
Д д	D	like d in debt	П п	P	like p in pet	Ы ы	Y	like i in hit
Е е	E	like e in debt or yet	Р р	R	like r in error	Ь ь	(none)	(none) (soft sign)
Ж ж	ZH	like s in measure	С с	S	like ss in mess	Э э	E	like e in bet
З э	Z	like z in lazy	Т т	T	like t in tell	Ю ю	YU	like u in mute
И и	I	like ee in meet	У у	U	like oo in boot	Я я	YA	like ye in yard
Й й	Y	like y in boy	Ф ф	F	like f in effect			
К к	K	like c in calf	Х х	KH	like ch in Scottish word loch			

73NP0120

Figure 13-20.—Transliteration table of the Russian alphabet.

SUBMARINE IDENTIFICATION

LEARNING OBJECTIVE: Explain the procedure for identifying submarines, including recognition features and the recognition coding system.

Submarines are the most elusive of all naval ships. To locate and prosecute (track) a submarine successfully is a formidable task, one to which a good portion of our Navy is devoted. In this section we discuss submarine recognition features, including nomenclature and profiles.

RECOGNITION FEATURES

The exterior view of submarines presents a very low silhouette; this is because submarines have a low center of gravity and, therefore, are normally two-thirds submerged while on the surface (fig. 13-21). The exterior or hull of submarines is

cylindrical and gradually tapers forward and aft to become the bow and stern respectively.

On older conventional submarines, the superstructure deck (called the main deck) extends virtually from the tip of the bow to near the stern. The deck is generally level. Beginning near the midships section, the deck rises gradually in the direction of the bow to a height of about 10 feet above the waterline. The freeboard of the after end of the main deck is about 4 feet.

Modern submarines still retain most design features developed and proven over the years, but new external styling is evident (fig. 13-22). The basic hull shape resembles a torpedo, with a rounded nose and control planes at the stern set at right angles to each other. Other surfaces show streamlined fairing.

RECOGNITION CODING SYSTEM

Most submarine recognition manuals use a visual coding system based on a general profile appearance (sail shape being the primary factor), sail placement



73NP0121

Figure 13-21.—Profile of a submarine.

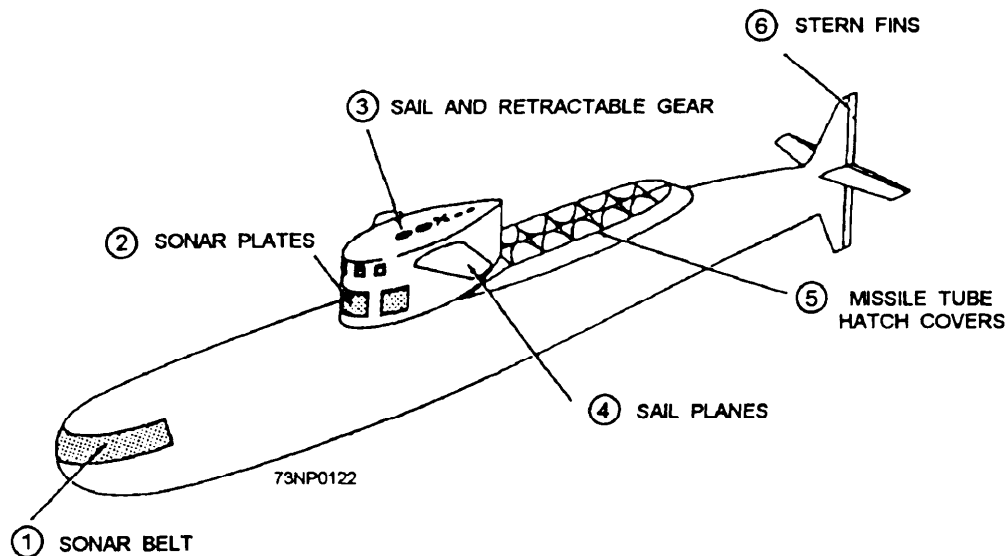

Figure 13-22.—Modern submarine.

on the hull, and bow profile. The visual coding approach is based on examining the profile appearance of a given submarine and assigning numerical values that best correspond with illustrated examples appearing in selected appearance group coding. Three factors are usually sufficient to identify a class; thus each submarine class has a three-digit number. In cases where several submarines possess the same appearance code number, their profile and photographs should be carefully compared to distinguish between them.

General Appearance Coding

Surface submarines and partially submerged submarines are best identified by their sail configuration; hence, the sail shape is the most important factor in coding the general appearance of submarines. (See fig. 13-23.)

Sail Placement Coding

The system for coding the sail placement parallels and reinforces the system outlined under General Appearance Coding. Generally, the sails of newer submarines are placed closer to the bow than those of older designs. In examining the five basic sail positions (fig. 13-24), you should choose the example that best shows the position of the sighted sail in relation to the hull. Using this system, you should be within two or three silhouettes in confirmation of submarine class and type.









Bow Profile Coding

Bow profiles (fig. 13-25) are assigned numerical values in an ascending order that coincides with the severity of the angle at which the stem or deck line approaches the waterline. On the newer submarines, the bulbous bow is seldom seen; when the submarine is surfaced, the deck line forward of the sail appears to slope gently into the water. On the older submarines the bow has a definite terminal point, and the angle of the stem is either raked or sheer. Note that in the coding of bow profiles, structures atop the bow are not considered as part of the bow shape. Bow shapes are often difficult to see because of observation angle or water wave action; but this should not constrain you from identifying a particular submarine based on the first two codes.

General Recognition Factors

The principal Soviet innovation is the streamlined *turtleback* sail, which has a curved topline that merges with the after trailing edge of the sail. For classification, the new *turtleback* sail is assigned appearance group code 1. (See fig. 13-23.)

Rectangular sails are so numerous that they must be broken down into subdivisions as to how they appear in relation to other features. The new SSBNs usually have a rectangular sail with sail planes. They also have a bullet-shape bow, a stern fin, and a prominently raised and broken deck line aft of the sail. The SSBN classes largely constitute appearance group 2 (fig. 13-25).

Group No.	Silhouette	Description
1		Streamlined Sail Sail has unbroken topline with no prominent steps or breaks. Topline blends with trailing edge as it curves toward deck line aft.
2		Rectangular Sail, Broken After Deck Line, Stern Fin Sail has unbroken topline and is basically rectangular. Prominent break in after deck line forms a knuckle above waterline. Stern fin is visible.
3		Rectangular Sail, Unbroken After Deck Line, Sloping Bow Deck Line, Stern Fin Sail has unbroken topline and is basically rectangular. There is no prominent break visible in after deck line. Deck line at bow slopes into waterline without revealing bow. Stern fin is visible.
4		Rectangular Sail, Unbroken After Deck Line, Blunt Bow, Stern Fin Same as Group 3 except forward deck line is relatively level and the bow profile is exposed.
5		Rectangular Sail, Unbroken After Deck Line, Blunt Bow No Stern Fin Same as Group 4 except no stern fin is visible above waterline.
6		Rectangular Sail with Minor Breaks in Topline Breaks in topline are not prominent enough to be considered steps and usually consist of raised well guards, fixed instruments, knuckles, etc.
7		Sail Stepped Down Toward Bow Sail has one or more prominent breaks in topline, forming a distinct step measuring 1/4 or more of the sail height. There may be a stern fin.
8		Sail Stepped Down Toward Bow and Stern Same as Group 7 except that a downward step aft is also present.
9		Sail Stepped Down Toward Stern Same as Group 7 except the downward step is toward the stern instead of the bow.





73NP0123

Figure 13-23.—General profile appearance of submarines.







Other appearance types with rectangular sails comprise groups 3, 4, and 5 (fig. 13-25). In these groups, hull features such as stern and bow type are the differentiating factors.

Appearance group 6 includes a small group of transitory types of design. In this group, the overall

appearance of the sail is rectangular, but the topline is broken with minor knuckles, protuberances, and fixed or semiretractable equipment. If a small step occurs, it measures less than one-fifth of the sail height and usually indicates a shield, a raised well cover, or a fixed snorkel exhaust casing. Generally speaking, this

Group No.	Silhouette	Description
1		Sail Well Forward on Hull Entire sail is well forward of hull midpoint.
2		Sail Slightly Forward Sail center is slightly forward of hull midpoint.
3		Sail Centered Sail center nearly coincides with hull midpoint.
4		Sail Slightly Aft Sail center is slightly aft of hull midpoint.
5		Sail Well Aft On Hull Entire sail is well aft of hull midpoint.

73NP0124
Figure 13-24.—Sail placement

Group No.	Silhouette	Description
1		Gently Sloping Forward deck line slopes gently into waterline. Bow is submerged and not visible.
2		Abruptly Sloping Forward deck line curves abruptly below waterline at bow. Bow proper is submerged.
3		Bluntly Rounded Forward deck line terminates with definite bow. Bow is visible and curved stern shape is discernible.
4		Bluntly Squared Same basic features as Group 3 except bow shows a vertical stern.
5		Bulbous Bow shows a rounded and raked appearance in profile.
6		Raked Bow shows stem is straight and inclined from vertical.
7		Upswept Sheer bow shows exaggerated upswing from forward deck line.

73NP0125
Figure 13-25.—Bow profiles.

group is composed of conversions and experimental prototypes that bridge the gap between the irregular shapes of World War II versions and the streamlined sails of the nuclear age. If the sail topline is broken and has an obvious step measuring one-fourth of the group sail height or more, it falls within groups 7 through 9 (fig. 13-23), depending on the position of the sail.

TYPES OF SUBMARINES

For the purpose of our discussion, we will categorize submarines into three distinct groups: attack, cruise missile, and ballistic. All three groups can be either conventionally powered (diesel/electric) or nuclear-powered.

Attack Submarines

Attack submarines (SS and SSN) are used primarily against shipping, both surface and subsurface. These submarines are designed for speed and maneuverability. Attack submarines use torpedo tubes, usually located forward and aft, to launch torpedoes, mines, and missiles.

Cruise Missile Submarines

Cruise missile submarines (SSG and SSGN) are designed primarily to attack surface ships. Their armament usually consists of surface-to-surface antiship missiles, torpedoes, and mines.

Ballistic Missile Submarines

Ballistic missile submarines (SSB and SSBN) are probably the most notorious of all submarines. Ballistic missile submarines usually maintain constant patrols that place their long-range surface-to-surface missiles within range of intended targets, such as major military and industrial installations.

MERCHANT SHIP IDENTIFICATION

LEARNING OBJECTIVE: Explain the procedures for the identification of merchant ships, including appearance groups, hull types, and sequence of uprights.

As a Signalman, you must be able to identify and report the various types of merchant ships. The purpose of this section is to acquaint you with the primary identification features unique to merchant ships. The two primary publications that will help you in your identification of merchant ships are *Merchant Marine Identification Guide—World* and the *Communist Merchant Marine Identification Guide*.

Any system used for identifying and reporting merchant ships during peacetime must be adaptable to wartime as well. Such ordinary aids to identification as stack markings, hull and superstructure paint combinations, striping, and house flags (all of which are of great assistance in peacetime identification) are easily camouflaged or painted over. Consequently, we must rely on those physical characteristics that are readily seen and difficult to alter or disguise.

IDENTIFICATION PROCEDURES

To identify a merchant ship, you must classify it by appearance group, hull type, and upright sequence. The appearance group is determined by the size, shape, and location of the superstructure. The hull type is determined by the shape of the hull and the number and location of islands. The upright sequence includes the identification and location of the masts, gantries, king posts, cranes, and funnels. Using these features and consulting *Merchant Marine Identification Guide—World* and *Communist Merchant Marine Identification Guide*, you can identify a merchant ship quickly and accurately.

APPEARANCE GROUP

The size, shape, and location of the superstructure on merchant ships depend on the functions of the ship. This identification feature is used to place the ship in one of three appearance groups (fig. 13-26.)

Group 1

Group 1 is the large superstructure appearance group. The superstructure exceeds one-third the overall length of the ship. Passenger ships generally belong in this group.

Group 2

Group 2 is the composite superstructure. The composite superstructure is located amidships and is less than one-third the overall length. These ships generally have a small blocklike superstructure with deck spaces devoted to cargo-handling equipment and hatches.

Group 3

Group 3 is stack aft. Stack aft means ships with funnels located within the after-third of the ship. However, if the superstructure exceeds one-third the overall length, the ship will be in appearance group 1.

HULL TYPE

Ships in appearance group 1 are placed under hull type 1. The determination of hull type for ships in appearance groups 2 and 3 is based on hull profile. Table 13-1 is a matrix of hull profiles and appearance groups that reflects hull-type numbers.

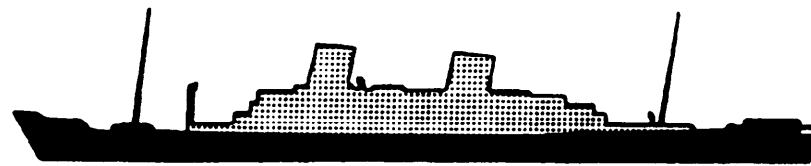

LARGE SUPERSTRUCTURE - GROUP 1 (TYPE 1)

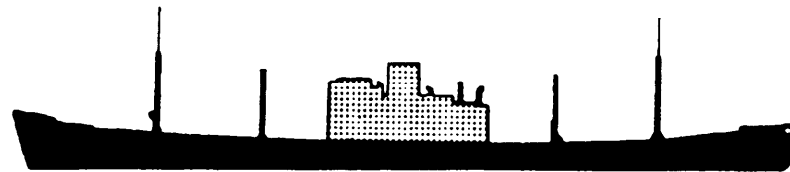

COMPOSITE (BLOCK) SUPERSTRUCTURE - GROUP 2 (TYPES 3-19)

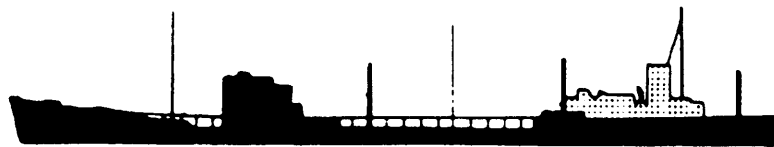

STACK AFT - GROUP 3 (TYPES 39-55)

73NP0126

Figure 13-26.—Appearance groups.

Table 13-1.—Hull Types

Hull Profile	Group 1	Group 2	Group 3
Large Superstructure	1	---	---
Flush Deck	---	3	39
Raised 1	---	5	41
Raised 2	---	7	---
Raised 1-2	---	9	43
Raised 1-3	---	11	45
Raised 1-2-3	---	13	47
Raised 1-long 2-3	---	15	---
Raised 12-(3)	---	17	49
Raised 1-23	---	19	51
Raised 2-3	---	---	53
Raised 3	---	---	55

Figure 13-27 is a display of all profile variations and lists the individual hull-type numbers. Note that appearance group 1 contains only one hull type. Within the remaining appearance groups, distinguishing hull features include the profiles of the hull and the number and location of islands.

A ship with a single weather deck extending from bow to stern is called a flush-deck ship. An additional deck spanning the breadth of the ship, but not extending from bow to stern, forms the island. Islands may be located at the bow, amidships, at the stern, or in a combination of these locations. However, any

APPEARANCE GROUP 1



APPEARANCE GROUP 2



APPEARANCE GROUP 3



73NP0127

Figure 13-27.—Type selector.

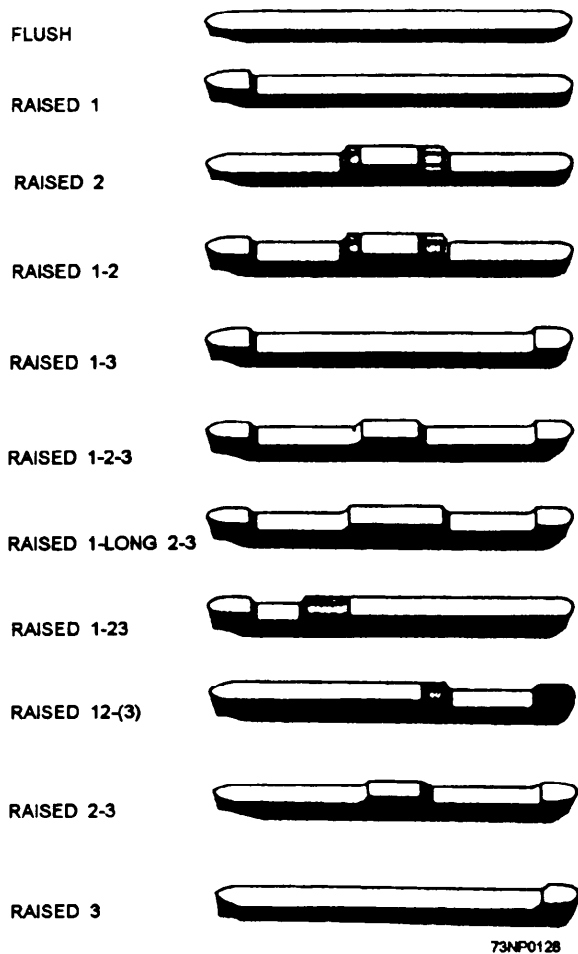

Figure 13-28.—Variations and locations of raises.

raises in the after-third of the ship but not extending to the stern are disregarded in determining the appearance type. Figure 13-28 shows the possible variations and locations of raises.

Islands are numbered according to their position from bow to stern. For example, the hull type of a ship with an island at the bow is raised 1, and an island amidships is raised 2. A ship with an island at both the bow and amidships is a raised 1-2; a well between islands is represented by a dash. The common three-island, well-deck-type ship is a raised 1-2-3. Two islands may be combined to form a continuous deck from the bow to the after end of the superstructure. This is referred to as a raised 12. A few ships with this configuration also have a raise aft and is called a raised 12-3. On some ships with a raise astern, the deck extends into the amidships section. On these ships, the after raise is considered a raised 23. When the deck does not extend to the amidships section, it is a raised 2-3. Then there are ships that have an enclosed superstructure at the stern of the ship. The first two-thirds of the deck is flush, and the main deck is raised. Such ships are raised 3.

Deckhouses are not raised. An island extends the full width of the ship's hull. Deckhouses are structures built on deck level but do not extend the full width of the ship. At times, the distinction between the deckhouse and the island is difficult to establish. Figure 13-29 illustrates the differences.

Bulwarks are not considered raises. A *bulwark* is the stake of shell plating that is above the weather deck and is designed to keep the deck dry and guard against losing deck cargo and personnel overboard. A bulwark may occasionally be difficult to distinguish from a raised island. A raise is generally from 2 to 3 meters high; a bulwark is generally about 1 meter high. Occasionally, a bulwark will be as high as a raise. It is then almost impossible to distinguish the bulwark from the raise unless there is an opening in the bulwark. This opening is a definite indication of a bulwark. A rail on top a raised section of the hull usually indicates a raise instead of an bulwark. Scuppers, or freeing ports, which permit rain and seawater to run off the deck, indicate a bulwark.

SEQUENCE OF UPRIGHTS

The coding of uprights (cranes, funnels, gantries, king posts, and masts) is the third step in identifying merchant ships. The presence of these verticals is indicated by the letters *C*, for crane; *F*, for funnel; *H*, for gantry; *K*, for king post; and *M*, for mast as they are located on the ship, starting at the bow. For example, the upright sequence for a ship with a king post, followed by a king post in the forward well, a funnel amidships, and another king post in the after deck well is coded KKF_K, as shown in figure 13-30.

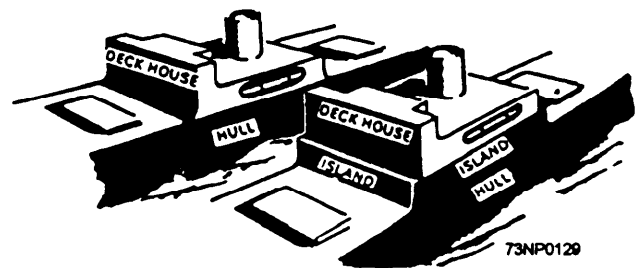

Figure 13-29.—Differences between deckhouse and island.

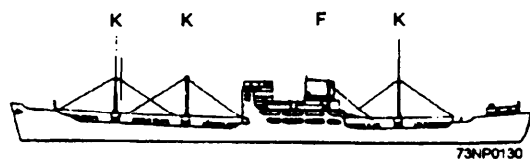

Figure 13-30.—Coding of uprights.

Masts

A *mast* is a post that has no cargo-handling gear. Masts can appear on the deck, bridge, or funnel of a ship. A mast on a king post is coded as a king post.

In all instances, masts are coded if they are heavy enough to be easily discerned. A mast installed on a funnel is coded as if it were located forward of the funnel.

A ventilator without cargo-handling gear is coded as a mast if it is prominent. Figure 13-3 1 shows the types of masts usually installed on merchant ships.

King Post

A *king post* is an upright with cargo-handling devices attached to it. Since king posts are designed

for handling cargo, they are located at the forward or after end of a hatch.

King posts may be arranged singly or in pairs. King posts located against the bridge, but not rising above it, are not coded.

A funnel serving as a king post is coded as if it were located after the king post.

A ventilator rigged for cargo-handling is coded as a king post if it is conspicuous. Figure 13-32 shows some frequently seen king posts.

Cranes

Cranes are cargo-handling devices. The whole unit pivots about its base and is usually capable of rotating 360°. Cranes are distinctive features and, when they can be easily seen, are coded. When cranes

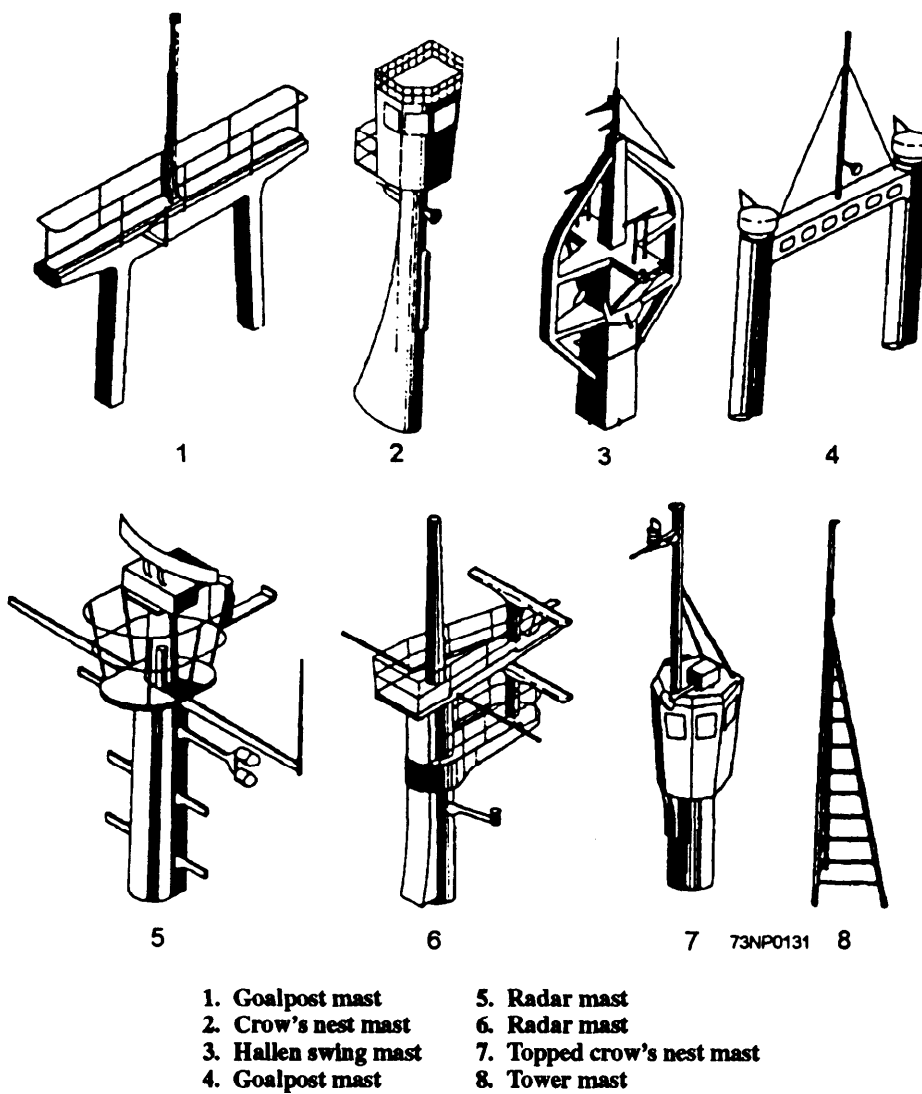
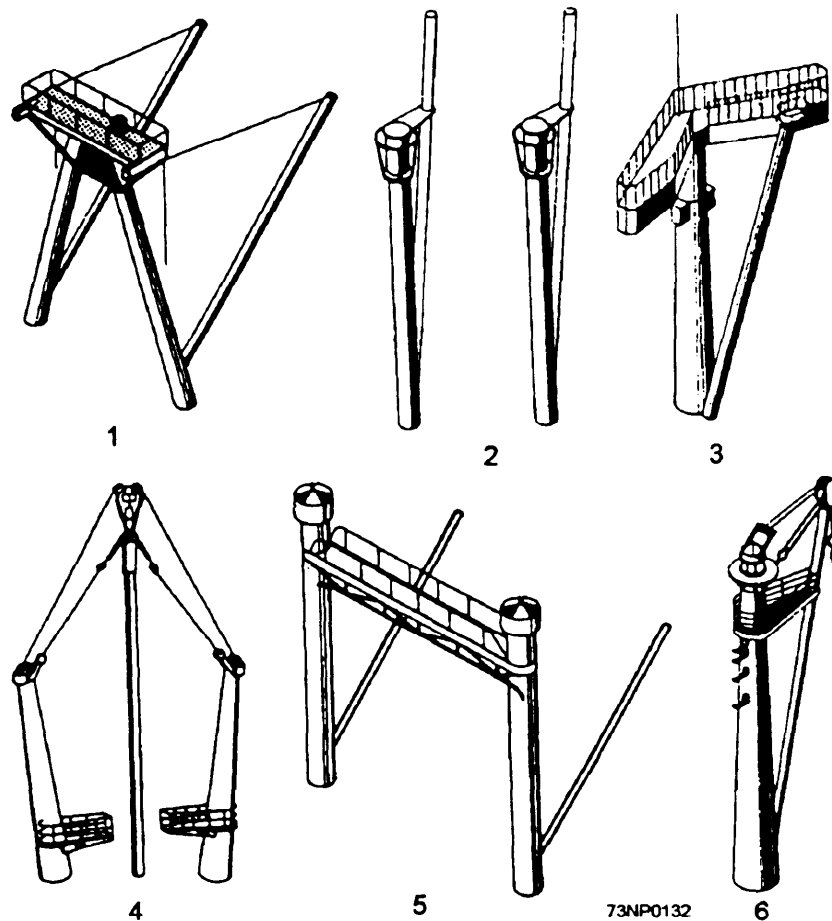

Figure 13-31.—Types of masts.



- | | |
|---|--|
| <p>1. Bypod king post A
 2. Parallel single king post
 3. Swept-back heavy-lift derrick</p> | <p>4 Stulcken heavy-lift
 5. Goalpost king post
 6. Soviet bulk heavy-lift derrick</p> |
|---|--|

Figure 13-32.—Types of king posts.

appear in pairs abreast, they are coded as a single crane. When located outboard from, and in line with, a mast, the crane is coded as if it were located forward of the mast. When two cranes are mounted on the same pedestal but are arranged fore and aft, they are coded as two cranes. Figure 13-33 shows examples of cranes.

Gantry

A gantry is unique in appearance and function. Typically, the gantry spans the width of a ship and has a boxlike shape. It also has the ability to traverse fore and aft along the ship's deck line, stopping over cargo holds. Figure 13-34 shows an example of a gantry.

Funnels

No distinction is made between the shapes of funnels on merchant ships. Funnels are not coded if

they are so small that they are difficult to see, including the small pipes found on some motor ships.

Though extremely rare, a few ships still exist with funnels that resemble king posts. Such funnels are coded if they appear after the king post.

Funnels paired athwartships are coded as a single funnel. Figure 13-35 shows examples of funnels.

BOW AND STERN

Bows and sterns can also assist in the identification of ships. Bow types (fig. 13-36) are as follows:

- Straight, plumb, or vertical—This type is the oldest type; it offers the most resistance to the sea.
- Raking or sloping, and curved and raking—Angle varies greatly. Clipper or cable bows come within this group.

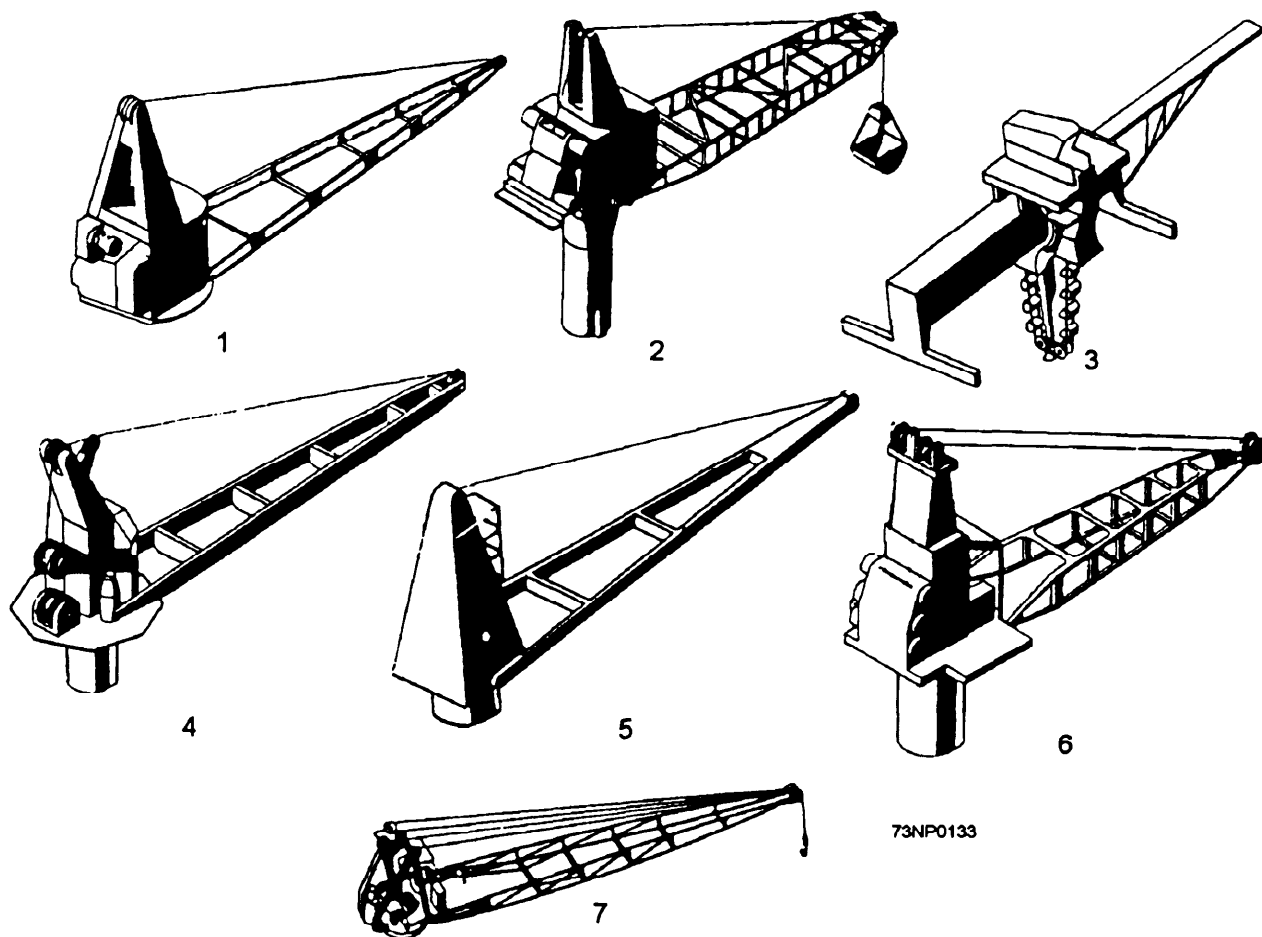

- | | |
|---|---|
| 1. Kampnagel deck crane | 5 Hagglund crane, built in Sweden |
| 2. Kampnagel deck bucket crane | 6. Deck crane |
| 3. Conflow-continuous flow ship unloader, built in W. Germany | 7. Hagglund rotary, electric deck crane |
| 4. Luffing deck crane, built in W. Germany | |

Figure 13-33.—Types of cranes.

- Maier—An outward curve, all rounded and not sitting on the water.

Stern types (fig. 13-37) are as follows:

- Counter—The stern is hooked and curved inward.
- Cruiser—The stern is butted and straight, rounding only at the bottom.
- Spoon—The stern is angled greatly. The spoon is a particular feature of German- or Russian-built ships.

MERCHANT SHIP CONCLUSION

Intelligence analysts depend on your merchant ship reports to formulate analyses relevant to both political and naval intelligence. Many countries use

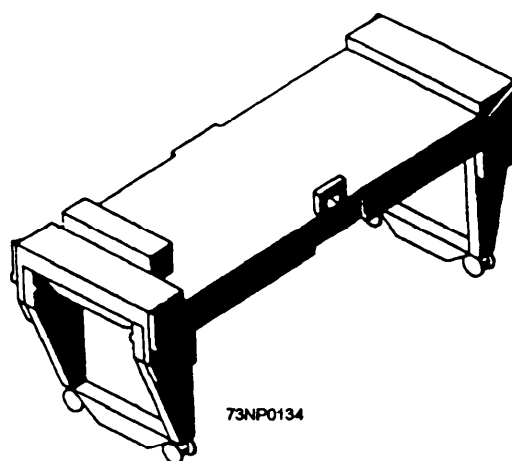
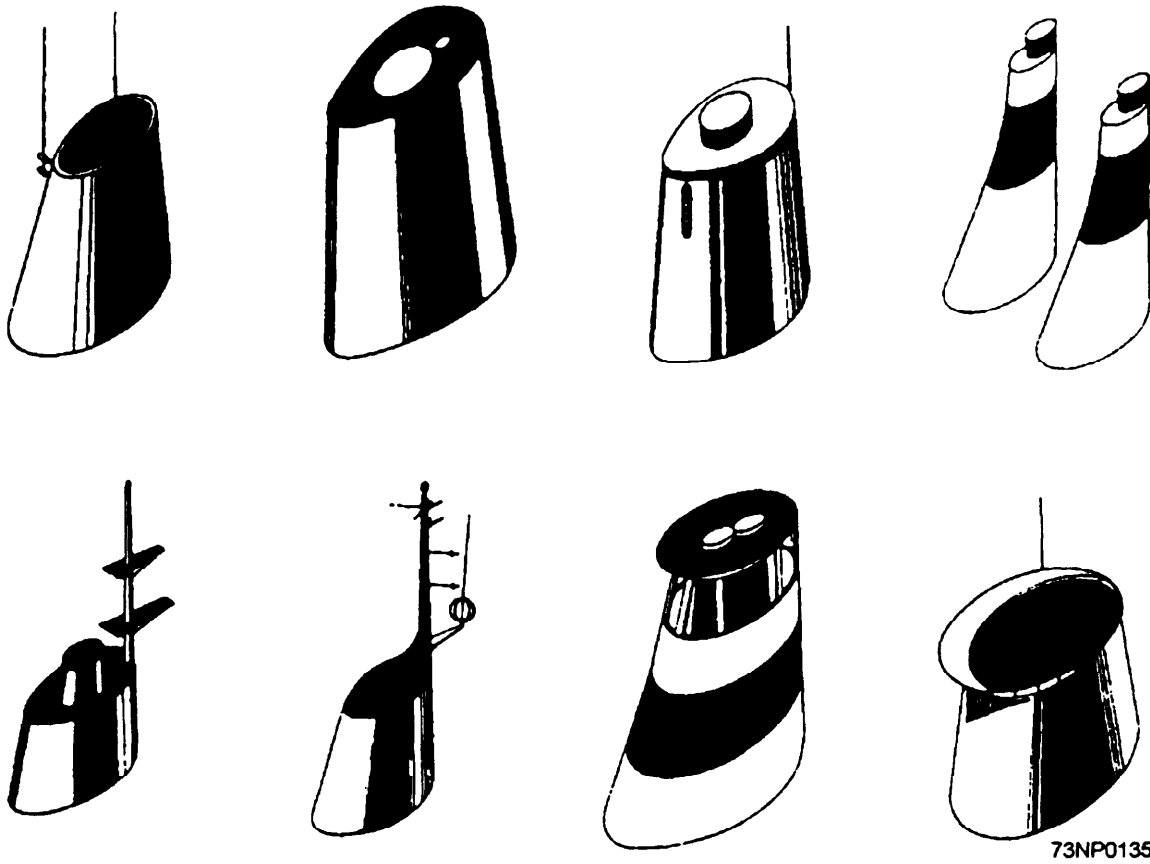

Figure 13-34.—Muckloader gantry.

merchant ships for military-related functions; so, whenever a merchant ship pops up on the horizon,



73NP0135

Figure 13-35.—Types of funnels.

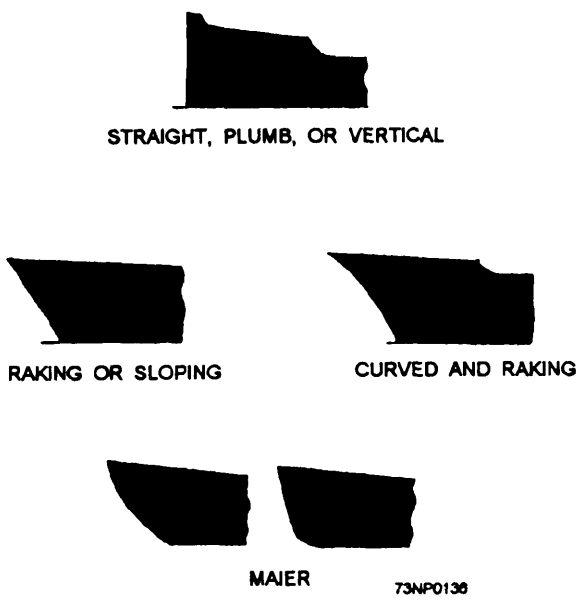

STRAIGHT, PLUMB, OR VERTICAL

RAKING OR SLOPING

CURVED AND RAKING

MAIER 73NP0136

Figure 13-36.—Bow designs.

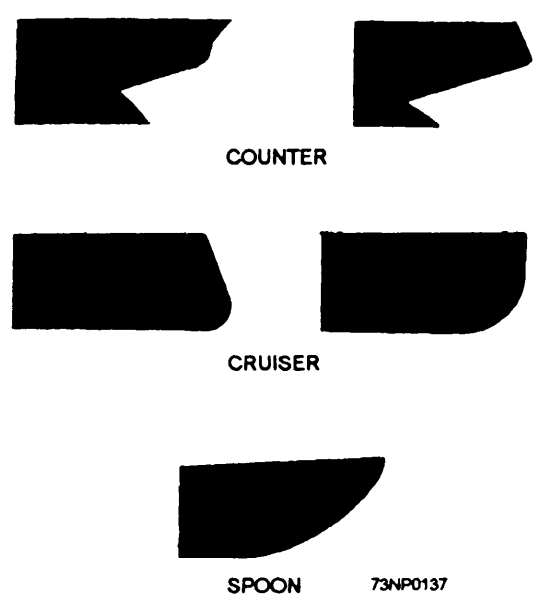

COUNTER

CRUISER

SPOON 73NP0137

Figure 13-37.—Stern designs.

write her up and pass it to the officer of the deck or appropriate personnel.

SUMMARY

This chapter is one of the most important chapters for a Signalman. In this chapter, you learned information to help you identify aircraft, ships (both naval and merchant), and submarines.

You learned that on-the-job training is a very effective way of learning the different aircraft, ships, and submarines. You also learned that aircraft, ship, and submarine characteristics are the major factors in identifying them. This chapter contains just the basics to get you started in identification. It is up to you to progress to the point that you become an expert in the identification of aircraft, ships, and submarines.

CHAPTER 14

TECHNICAL ADMINISTRATION

Visual communication procedures and doctrine exist only to help Signalmen perform their duties. Procedures and doctrine can be taught through on-the-job training, but this method is usually unsatisfactory because procedures are learned only as different situations arise. Classroom instruction and drills are less expensive for hours spent and results achieved. This is because methods, procedures, and safety precautions must be taught in their order of importance or in some other logical order that will aid the trainee in committing them to memory.

Your training program should include complete information on message forms, operating signals, prosigns, visual responsibility, flashing light, semaphore, and flaghoist. Circumstances, however may dictate the priority you give to each subject. If you have a well-established training program and personnel with experience, follow the program in its planned sequence. By so doing, you assure the widest possible degree of coverage during the ship's regular training cycle. If, on the other hand, you have a group of inexperienced people and you are setting up a new training program, you will find it profitable to alter your training program. Emphasize those subjects of immediate importance and ignore, for the time being, those portions that are less urgent.

The Commanders-in-Chief, Atlantic and Pacific Fleets, have primary responsibility for the tactical training of naval forces. Naval vessels can expect a comprehensive assessment by Afloat Training Groups (ATGs) to include a review of future training requirements, current training programs, personnel billeting, and material/equipment status to assist them in preparing a unit training package. Another phase of this review will be performance based. Information on assessments can be obtained from the ATG prior to its commencement. Another source of information is COMNAVSURFLANTINST/COMNAVSURF-PACINST 3502.2A.

In this chapter, you will learn about drills and exercises, standing orders, and operation orders and plans.

DRILLS AND EXERCISES

LEARNING OBJECTIVES: Describe the procedure for grading and critiquing visual drills and exercises. Explain the importance of security when participating in visual drills and exercises.

Drills and exercises are a large part of the communications department's training program. Noncompetitive exercises and emergency drills are performed to acquaint personnel with correct procedures and methods to increase their efficiency. Competitive (graded) exercises are performed when they are assigned by the type commander or other competent authority. Results of these exercises are used to keep the type commander informed of the readiness state of individual units. Maximum benefit is derived when an exercise is observed and analyzed by the umpires and various assistants who are assigned by the officer scheduling the exercise (OSE).

Strike Warfare (STW), Antisurface Ship Warfare (ASW), Intelligence (INT), Electronic Warfare (ELW) and Command, Control and Communication Exercises (CCC), FXP 3, lists exercises that are designed for visual communications or have visual communications as a part of the overall exercise. These exercises include Flaghoist, CCC-15-SF; Flashing Light, CCC-16-SF; Semaphore, CCC-17-SF; and Comprehensive Communications Assessment, CCC-27-SF. Each of the exercises has its own system of grading. You should be aware of these systems to detect discrepancies when observing an exercise. Remember, observation of personnel during an exercise is a method of determining what area needs more intensive training. For visual communications grading sheets, see chapter 14 of FXP 3.

CRITIQUES

A critique is a critical review of an exercise held in the form of a conference. All graded exercises should end with a critique, attended by the umpire, assistants, and key personnel of the unit being graded.

You should become familiar with critiques and derive maximum benefit from the one you attend as a member of the exercise ship so you can present meaningful appraisals.

During the exercise, observers must keep a chronological record of the events that take place or make notes of occurrences that may have a bearing on the outcome of the exercise, such as the following:

- Procedural errors
- Handling times
- Outstanding performances
- Equipment failures and repairs

The important aspects of each observer's notes are presented as a part of the critique. The following points about the exercise should be covered:

- Manner of performance
- Errors committed
- Deficiencies of material or procedure
- Recommendations for improvements of material and personnel performances

The last point, recommendations for improvements, may be more important than any other item because improvement is the goal of all training. Recommendations may be limited to minor changes in procedures or to training in a particular area. Conversely, they may encompass overhaul of entire systems and addition or replacement of equipment.

Tentative grades may be assigned at critiques. Final appraisals, however, are the responsibility of the type commander, who can compare the performance of one unit with another. The type commander also strives for uniformity of grading within the type.

VISUAL COMMUNICATIONS (CCC-15-SF THROUGH CCC-17-SF)

Visual communications exercises may be used for day-to-day training and evaluations or as the criteria for operational readiness inspections (ORIs). For all exercises, preparation and execution must be oriented toward training. It is intended that various communications exercises from FXP 3 be performed in combination to test all installed systems and functions. The operational or type commander designates the exercises for your ship. During periods of emission control (EMCON), visual signaling may be the only method of communications available.

Therefore, proficiency in visual communications must be maintained. The series of visual signaling exercises (CCC-15-SF through CCC-17-SF) is designed to train and evaluate personnel in visual signaling procedures.

COMMUNICATIONS EVALUATION

The visual communications exercises may be used individually or in combination to satisfy the following evaluation requirements: training, ORI, predeployment COMM/ELEX inspection, and overall communications exercises.

The officer conducting the exercises (OCE) supplies the following information:

1. Where: Ship's name, location (in port/under way)
2. When: Starting time and duration of exercise(s)
3. Which: What exercises and for which installed system(s)
4. Who: The senior observer

Any additional comments required will be issued so the exercise unit will be fully prepared.

GRADING

The number of points assigned for each evaluation factor is the norm. However, the senior observer may deduct points to the degree that circumstances show a need. Additionally, if performance or material readiness is of exceptionally poor quality, the senior observer may deduct more points than are assigned. The senior observer obtains the final grade for the exercise by subtracting points lost from 100.

SECURITY

Any action resulting in a reportable security violation, or any action, if not stopped or prevented by an observer, that would have resulted in a reportable security violation will cause an exercise to be evaluated as unsatisfactory. No numerical grade will be assigned, and the exercise will be canceled at that point. Report violations through the chain of command. The reporting of a security violation can be as low as operator or as high as supervisor.

All nonreportable security violations will result in the loss of five points of credit. Three or more of these nonreportable violations will result in grading that exercise unsatisfactory. Examples of nonreportable violations are classifications not in letters larger than

the text on a page and improper classification of extracts.

COMPREHENSIVE COMMUNICATIONS ASSESSMENT

The Comprehensive Communications Assessment exercise (CCC-27-SF) evaluates the ship's overall communications in a three-phase evolution. This exercise requires the combined efforts of both signal and radio personnel to research operation orders (OPORDs) and plan all the communications requirements. The shipboard communications plan can be developed for an actual operation or a constructive facsimile, depending on the OCE's requirement.

COMMUNICATIONS PLAN

A ship's *communications plan* lists all the communications requirements in detail for a specific operation covering a specified period of time. It contains all the sequential information required for operations and communications personnel to achieve the communications commitments of a ship. The department/division officers, leading petty officer, and supervisors research effective OPORDs for communications requirements and combine them into an effective plan that can be carried out by the working personnel.

WARTIME PROVISIONS FOR VISUAL SIGNALING

Chapter 16 of NWP 4 contains procedures to change from peacetime communications procedures to wartime communications procedures or for other emergencies. Provisions of the chapter are carried out by the Chief of Naval Operations, who issues the directive "Execute Chapter Sixteen NWP Four." Immediately upon receipt of the directive, commanders must begin the measures indicated in that chapter.

Stipulations of chapter 16 of NWP 4 are classified; therefore, they cannot be covered in this text.

STANDING ORDERS

LEARNING OBJECTIVES: Identify standing orders. List personnel responsible for standing orders and the reason for having standing orders.

Because individuals differ, each leading Signalman runs his or her signal team, differently. All good Signalmen carry out all orders received and follow standard organization closely. There will also be variations in how individuals accomplish certain tasks. In addition to differences in personalities of leading Signalmen, the types of individuals that make up a signal team have a bearing on the way the leading Signalman performs. As the leading Signalman, you must be able to explain your way of doing tasks to all subordinates clearly. You should use standing orders containing personal instructions on what will be required. Read these orders to each member, and get a signature acknowledging his or her understanding. You must then hold all hands responsible for following all provisions of your orders.

When a period of several months is involved, a written order obviously is more effective than a verbal order. It also is superior because a group, if told to do something, can easily misunderstand. A few members of the group will interpret the verbal order one way, and some will interpret it another way. A written order with a verbal explanation eliminates doubt and confusion, and leaves no excuses for failure to follow.

Standing orders for the organization, administration, and function of the signal team must have the signature of the communications/signal officer. The leading Signalman is responsible for preparing these orders in the rough and submitting them to the division officer for approval.

Before writing standing orders, determine what directives exist. Review orders written by a predecessor and discuss any changes or comments with the division officer.

Standing orders must agree with the ship's and the department's organization books. Depending on the completeness of the latter book, it may not be necessary to prepare standing orders. Some departmental organization books are a list of standing orders in various divisions in the department. Standing orders could, therefore, be either a supplement to previously issued department organization orders or an actual part of that department's written organization.

As previously stated, standing orders should be explained fully to all hands. A record of signatures should be kept to show that each member has read and understands these orders. Standing orders should also be read and explained when new personnel report on

board. It would be a good idea to read some of the standing orders every few months at morning quarters.

Where practical, standing orders should be posted so they will be visible to all the team. You should personally make sure that one copy each of the ship's organization book, ship's orders (and regulations), operations department organization book or standing orders, and *the Uniform Code of Military Justice* are always available in the living compartment. You can secure these books by a chain with the watch, quarter, and station bill.

As the leading Signalman, do not make the mistake of having an excellently written organization standing order and then fail to follow through. Require compliance with these orders. Point out instances where failure to follow orders created problems. It is far better to have one good standing order that everyone follows than to have ten that are ignored.

Remember that conditions change. You can develop good standing orders and have them obeyed, but they will lose their value or effectiveness if they are not revised as new situations arise. To help you in preparing adequate standing orders, refer to figure 14-1. Note that it bears the number 2-92. That means it is the second standing order for the year 1992.

OPERATION ORDERS AND PLANS

LEARNING OBJECTIVES: Identify the sections of operation orders and plans. Explain the procedure for preparing operation orders and plans.

Operation orders (OPORDs) and plans (OPLANs) are designated to help the signal bridge personnel in performing their duties. This section explains OPORDs and OPLANs.

OPERATION ORDERS

Before the start of underway periods, all signal bridge personnel should be familiar with the communications portion of the OPORD or the letter of instruction (LOI). The leading Signalman obtains these orders from the communications/signals officer. Due to the few copies available, the needed information may be extracted. At the minimum, a list showing the task organization, schedule of events, and call signs should be on the signal bridge. Whenever possible, the leading Signalman of the ships assigned to the task organization should arrange a meeting for

a pre-underway brief. During this brief, information covering visual communications, use of call signs, and drills should be discussed. You gain an advantage by discussing these items before sailing.

Changes to OPORDs are issued frequently. Therefore, the leading Signalman must consult the OPORD often to make sure the signal team is kept up to date on any such changes.

OPORDs are issued to effect the coordinated immediate or near-future execution of an operation. They are prepared in a standard approved format, as stated in NWP 11, *Naval Operational Planning*.

An OPORD is a basic plan and usually consists of the heading, body, ending, and (as needed) detailed procedures (in the form of enclosures called annexes and appendices). The basic plan is concise, and contains only details necessary for a clear, overall picture of the operation. Annexes themselves may be short or long. They often have appendices and tabs to elaborate on the many details to be considered in a large and complicated tactical operation.

The most important portion of the OPORD (for communications personnel) is the communications annex. This annex gives information on communications that is too extensive to be included in the basic OPORD.

The amount and type of information in a communications annex depends on the purpose of the plan or order and on the mission of the command.

OPERATION PLANS

An OPLAN is a directive for carrying out an operation or a series of operations extending over a large geographic area. The plan usually covers a considerable period of time and is prepared well in advance. The plan may include information on the time it will become effective, or it may merely state that it will become effective when signaled by appropriate authority. The operation plan is the instrument upon which subordinate commanders base directives to their commands covering specific tasks assigned. Usually an OPLAN is designed to deal with some future situation or condition which may or may not come about.

For more information concerning OPORD and OPLANs, refer to NWP 11, *Naval Operational Planning*.

COMMUNICATIONS OFFICER'S ORDER NUMBER 2-92

From: Communications Officer

To: All visual signal personnel

Subj: DUTIES OF THE SIGNAL SUPERVISOR

1. You, as the signal supervisor, during your watch must be in complete control of the signal personnel on watch and of the signal material in use. You must ensure that a proper lookout is kept by your watch at all times, taking care that your watch does not congregate. You must concern yourself primarily with carrying on the signal activities and maintaining discipline, and secondarily, as necessary, with operating. You are responsible for seeing that instructions for the internal routing and filing of messages applicable to the signal section are complied with. During your watch you are required to do the following:

- a. Make sure that an alert watch is maintained at all times.
- b. Coordinate and supervise the operations and activities of the watch in such a way as to maintain efficiency in handling visual traffic with a minimum of noise and confusion.
- c. Be familiar with *the Allied Maritime Tactical Signal and Maneuvering Book, Visual Call Sign Book*, and all applicable instructions pertaining to visual communications.
- d. Be thoroughly familiar with the *International Code of Signals* and the procedures for communicating with merchant ships.
- e. Be familiar with combined and joint communication instructions and publications with respect to visual signaling.
- f. Know the recognition and identification signals in effect.
- g. Be proficient in all forms of visual communications, including drafting messages for transmission in any visual system.
- h. Keep yourself and the watch informed of the disposition, organization, formation, and location of all units in company.
- i. Know the responsibility of your ship for relaying and repeating visual signals and messages.
- j. Be responsible for safeguarding all communication publications on the signal bridge.
- k. Conduct effective training and instruction for the Signalmen on every watch, unless operating condition positively prevent it.
 1. Be responsible for the cleanliness and orderliness of the signal bridge and the personnel on watch.
- m. Thoroughly familiarize yourself and your watch with the location and use of emergency signal equipment including pyrotechnic kits and pyrotechnics.
- n. Acquaint yourself and your watch with the duties in the various emergency bills, with particular emphasis In the man overboard bill.

2. You, as the signal supervisor, are responsible for maintaining the visual signal log.

a. The visual signal log must contain a record of *all signals* from the *Allied Maritime Tactical Signal and Maneuvering Book* and/or other signal books as sent or received. The date, time of execution, originator, addressees, method by which signals are sent or received, and the signal itself, but not its meaning, must also be included in the log. It also includes identification data on all other visual traffic and all noteworthy events that affect the visual watch, such as relieving the signal watch, exchange of calls, casualties to visual equipment, and the like. The record must remain on the signal bridge in custody of the signal supervisor, and must be signed by the supervisor upon being relieved of the watch. The visual log must be kept with a new page starting at the beginning of each radio day.

Figure 14-1.—Standing order sample.

b. The method of transmission must be logged on all messages as follows:

<u>Abbreviation</u>	<u>Meaning</u>
FH	Flaghoist
FL	Small signal searchlight
SL	Large signal searchlight
BK	Yardarm blinker
SEM	Semaphore
NFL	Infrared directional
NBK	Infrared nondirectional
MPL	Multipurpose light

c. Any signal requiring action other than that demanded by the immediate tactical situation should be written up and handled as a regular message, with the additional logging of the signal in the visual log.

d. Messages and signals having a specified time of execution are given the same routing and handling as in the preceding step. (Includes message being written on message blanks.) A copy of all tactical messages goes to the OOD for filing; one copy is kept by the supervisor as a safeguard against loss; remaining copies are sent to the communication center. The original, after it is initialed by the CWO, is returned to the visual file.

e. Emergency messages, including executive method, abbreviated plaindress, and high-priority precedence messages, are accorded the normal routing to the communication center only after the signal force notifies the person(s) concerned.

3. In port, the duty Signalman/signal supervisor will man the signal bridge as required to perform the inport signal functions as outlined in signal publications and SOPA instructions.

Submitted:/s/J.A. DOE, ENS, USN
Communications Officer

Approved:/s/J.K. FROST, LCDR, USN
Ship Control Officer

Figure 14-1.—Standing order sample—Continued.

SUMMARY

In this chapter, you learned the procedures used for grading and critiquing visual drills and exercises. You learned about the grade sheets and where to locate

these sheets. We also discussed standing orders and the effect they have on the signal team, the difference between OPODs and OPLANs and the wartime provisions for visual signaling. Now it is up to you to put what you have learned to use.

APPENDIX I

GLOSSARY

- ABEAM**—Bearing 90° or 270° relative from own ship.
- ACP**—Allied Communications Publication.
- CELESTIAL NAVIGATION**—Navigation with the aid of celestial bodies.
- CLASSIFICATION**—The determination that official information requires, in the interest of national security, a specific degree of protection against unauthorized disclosure, coupled with a designation signifying that such a determination has been made.
- CODRESS**—Message having the address buried in the encrypted text.
- COMMISSION PENNANT**—A long, narrow, starred and striped pennant flown aboard a commissioned ship.
- CONVOY**—A number of merchant ships or naval auxiliaries, or both, usually escorted by warships and/or aircraft, or a single merchant ship or naval auxiliary under surface escort, assembled and organized for the purpose of passage together.
- DAYSHAPES**—Shapes specified in both International and Inland Rules of the Road to visually indicate particular operations or situations from one vessel to another.
- DEBARKATION STATION**—The place on a ship where personnel assemble to debark in boats.
- DECLASSIFICATION**—The determination that in the interest of national security, some classified material no longer requires any degree of protection against unauthorized disclosure, coupled with removal or cancellation of the classification designation.
- DEFENSE MAPPING AGENCY**—Government agency that produces and sells navigational charts and publications.
- ENCODE**—To convert plain text into unintelligible language, usually word by word, by means of a code book
- FATHOM**—A unit of length equal to 6 feet.
- FLAGHOIST**—A nondirectional means of transmitting signals with predetermined meanings taken from authorized publications. The U.S. and Allied Navies use 68 different flags/pennants or combinations thereof for this purpose. International use consists of 40 different flags and pennants.
- FLASHING LIGHT**—The term applied to the transmission of signals by light. The equipment employed may be directional or nondirectional in operation. The use of directional flashing light reduces the possibility of its interception, thus providing some security. When security is required at night, only highly directional flashing light should be used and its brilliancy should be the minimum necessary to provide communication. Nondirectional flashing light permits simultaneous transmission to a number of stations in any direction but has little security from interception, particularly at night.
- FORETRUCK**—The highest point of the forward mast.
- FORMATION**—Any ordered arrangement of two or more ships or aircraft proceeding together.
- FUSELAGE**—The body of an airplane.
- GAFF**—A small spar abaft the mainmast from which the national ensign is flown when the ship is underway.
- GIVE-WAY VESSEL**—As directed by Rules of the Road, any vessel required to keep out of the way of another vessel.
- GNOMONIC PROJECTION**—A map projection in which points on the surface of a sphere or spheroid, such as Earth, are conceived as projected by radials from the center to a tangent plane.
- GREENWICH MEAN TIME**—Local mean time at the Greenwich meridian; the arc of the celestial equator, or the angle at the celestial pole, between the lower branch of the Greenwich celestial meridian and the hour circle of the mean sun, measured westward from the lower branch of the Greenwich celestial meridian through 24 hours;

Greenwich hour angle of the mean sun, expressed in time units plus 12 hours.

GUIDE—Vessel designated in a formation or disposition as the one for others to keep station on.

GUN SALUTE—Blank shots fired to honor a dignitary or in celebration.

H-HOUR—The term used to designate the time for an operation to commence.

HEAD-ON VESSEL—One vessel meeting another on a reciprocal or nearly reciprocal course involving risk of collision.

HOIST—To move an article vertically upward by means of some hoisting rig.

HULL DOWN—Said of a vessel when, because of distance and curvature of Earth, only the superstructure is visible.

INFRARED—Transmission of signals by light outside the visual spectrum. This method, which may be directional or nondirectional, necessitates the use of special equipment and affords greater security than normal visual means.

IRISH PENNANT—A loose end of line carelessly left dangling.

JANAP—Joint Army-Navy-Air Force Publication.

LATITUDE—Distance north (*N*) or south (*S*) of the equator, expressed in degrees and minutes.

LONGITUDE—Distance east (*E*) and west (*W*) of the prime meridian, which runs through Greenwich, England.

LORAN—An electrical navigation system by which hyperbolic lines of position are determined by measuring the differences in the time of reception of synchronized pulse signals from two fixed transmitters.

MANEUVERING BOARD—A polar coordinated plotting sheet devised to aid in the solution of problems involving relative movement.

MASTHEAD LIGHT—The white running light placed over a vessel's fore-and-aft centerline showing an unbroken light over an arc of the horizon of 225°, fixed to show the light from right ahead to 22.5° abaft the beam on either side of the vessel.

MEAN TIME—Time based upon the rotation of Earth relative to the mean sun.

MERCATOR PROJECTION—A conformal cylindrical map projection in which the surface of a sphere or spheroid, such as Earth, is conceived on a cylinder tangent along the equator.

MESSENGER—(1) A line used to haul another heavier line across an intervening space; (2) One who delivers messages.

NEED-TO-KNOW—A criterion used in security procedures that requires the custodians of classified information to establish, prior to disclosure, that the intended recipient must have access to the information to perform his/her official duties.

NIGHT VISION DEVICES—Precision instruments that use electronic optics for observation, surveillance, and navigation. Also referred to as Night-Vision Sights.

NTP—Naval Tactical Publication.

NWP—Naval Warfare Publication.

OCCULTING LIGHTS—A navigational aid in which the period of light is equal to or more than the period of darkness.

OCCUPATIONAL STANDARDS—The minimum requirements for enlisted occupational skills of a certain rate or rating.

OFFICIAL INFORMATION—Information that is owned by, produced by, or subject to the control of the United States Government.

OFFICIAL VISIT—A formal visit of courtesy requiring special honors and ceremonies.

OMEGA—An electronic navigational system.

PELORUS—Device for taking relative bearings.

PERSONNEL QUALIFICATION STANDARDS—Qualification for officers and enlisted personnel to perform certain duties.

PHYSICAL SECURITY—That part of security concerned with physical measures designed to safeguard personnel; to prevent unauthorized access to equipment, installations, material and documents; and to safeguard them against espionage, sabotage, damage, and theft.

POSITION ANGLE—The number of degrees an object seen in the sky is above the horizon.

POWER-DRIVEN VESSEL—Any vessel propelled by machinery.

PRECEDENCE—The relative order in which naval messages are to be handled and delivered.

PYROTECHNICS —Ammunition containing chemicals that produce smoke or a brilliant light in burning; used for signaling and illumination.

QUICK-FLASHING LIGHT—A navigational light, such as a lighthouse, that flashes continually at least once a second.

RADIOTELEPHONE (R/T)—Used by ships and aircraft as the primary method for voice tactical and administrative communications.

RELATIVE BEARING—Bearing relative to heading or to the ship.

SAILING DIRECTIONS—A book issued by the Navy Department to supplement charts of the world. *Sailing Directions* contains descriptions of coastlines, harbors, dangers, aids to navigation, and other data that cannot conveniently be shown on a chart.

SECURITY CLEARANCE—An administrative determination by competent authority that an individual is eligible, from a security standpoint, for access to classified material.

SEMAPHORE—May be considered directional or nondirectional; however, nondirectional

procedures are used during transmission. This method uses small hand flags during daylight hours and wands fitted with red lenses during hours of darkness. The position or movement of the flags represents letters.

SIDELIGHT—A running light showing green to starboard and red to port, showing an unbroken light over an arc of the horizon of 112.5°, fixed to show the light from right ahead to 22.5° abaft the beam on the respective sides.

SOUND SIGNALING—The use of sirens, whistles, bells, and similar devices used to transmit short messages normally consisting of prearranged signals. Such methods are slow and satisfactory for short messages only; they are usually confined to warning or alert signals.

STANDARD OPERATING PROCEDURES (SOP)—Guidelines tailored to the unique requirements of a signal bridge. These orders are drafted by the leading Signaller and approved by the communications officer.

VISUAL SIGNALING—The means of passing tactical and administrative traffic between ships within visual signaling range, and between ships and shore stations.

APPENDIX II

FLASHING LIGHT AND SEMAPHORE DRILLS

FLASHING LIGHT

LEARNING OBJECTIVE: List tips on sending and receiving flashing light and on light qualifications.

International Morse code, a series of dots and dashes representing letters and numerals, is the standard for all flashing light and radio CW communications. The original code system was worked out in 1832 by Samuel F. B. Morse.

You must know international Morse code before you can use flashing light equipment effectively. Figure AII-1 shows the alphabet, numbers, and punctuation with the code equivalent. Basically, the code consists of 44 sight patterns: 26 letters, 10 numerals, and 8 punctuation marks. Each sight pattern (mental picture) except for punctuation contains from one to five dots or dashes (dits or dahs) or a combination of both, representing a letter or numeral. Except for the left parenthesis and slant/oblique stroke, punctuation sight patterns consist of dots and dashes in groups of six.

Experience has proved that the best way for most communications personnel to learn code is by “wholes.” For example, the Radioman is taught to relate whole tonal sounds to characters. Similarly, the Signaller should learn by whole sight patterns. Don't break each character into dits and dahs that you have to count. Try, instead, to learn each character as a complete mental picture. When you see one dit and one dah, say and think the letter A. Don't count them one dit, one dah, and then conclude that it is the letter A.

The best tip you will ever get on how to be a good Signaller is this: **PRACTICE**—don't neglect it! Practice is the stepping-stone to success. When you see a good Signaller sending and receiving a message on the light, you can rest assured that he or she had plenty of practice.

Once you memorize the code, ask one of the more experienced Signaller to send to you, using a blinker card, a multipurpose light, or even one of the searchlights. For the first few times, have the sender

to tell you in advance what character he or she is going to send so you can get use to how that particular sight pattern looks. When you are reasonably sure you have the sight patterns memorized, ask the sender to send a character without telling you what it is, and you call out the character. If you miss, ask the sender to tell you at once what character it was and ask him or her to repeat it. After you gain considerable practice on individual patterns, have some code groups consisting of random characters sent to you. If you notice that you confuse a few characters with others or that you seem to miss them more often than the rest, devote more time to those characters.

Practice these code groups as starters:

AFARF	EBBEU	NSPNP	LMZLM
ARFQZ	FEKUG	RBAPU	GVMCD
UQIWT	EHOXA	YSFTI	KNPUR
UFIEI	IAZIP	CBRIE	ULXWK

You can make up all sorts of combinations yourself. Just be sure they are code groups, not ordinary words. At this stage of the game, there is a definite reason why you should not attempt plain language drills: You may fall into the habit of anticipating the rest of the word or even the next logical word in the text.

When you become really proficient in receiving code groups, only then should you progress to plain language. Even in these drills, try not to anticipate the next letter or word. You will be wrong more often than right, and you will find when you guess wrong you become confused and miss the entire word. Anticipating is a bad habit.

TIPS ON SENDING FLASHING LIGHT

After you become fairly adept at receiving, try sending code. You will find this phase a bit easier. Keep in mind, however, that there is a definite physical limitation to the speed with which flashing light can be sent and still be readable. Depending upon the skill of the operator, the 12-inch Navy signal searchlight can be used to send up to 15 words a minute.

NEVER SEND FASTER THAN YOU CAN RECEIVE. If you transmit a message at 10 words a

LETTER	NUMBER	
A	1	
B	2	
C	3	
D	4	
E	5	
F	6	
G	7	
H	8	
I	9	
J	0	
K	PUNCTUATION (MORSE) COLON	
L	COMMA	
M	HYPHEN OR DASH	
N	PARENTHESIS/LEFT HAND BRACKET	
O	PARENTHESIS/RIGHT HAND BRACKET	
P	PERIOD OR DECIMAL POINT	
Q	QUESTION MARK	
R	SLANT/OBLIQUE STROKE	
S	PUNCTUATION (SEMAPHORE)	
T	COLON	OS
U	COMMA	MIM
V	HYPHEN OR DASH	DU
W	PARENTHESIS/LEFT HAND BRACKET	KN
X	PARENTHESIS/RIGHT HAND BRACKET	KK
Y	PERIOD OR DECIMAL POINT	AAA
Z	QUESTION MARK	IMI
	SLANT/OBLIQUE STROKE	XE

Figure AII-1.—Formation of characters in Morse Code.

minute, an experienced SM probably will reply at the same rate; but you will be out of luck if you can read only 6 or 7 words a minute. Speed, incidentally, does not imply noise. The shutters can be moved quickly without banging them up and down.

When you are first learning to send code by light, it is wise to increase the interval between characters and groups. The extra time enables the beginner to see each character in the proper time ratio. Moreover, the greater period between the characters and groups allows the mind to verify or realize what the eyes have seen. Practice reduces this reception time, and the periods can be decreased.

The period the shutter remains open for a dit or dah and closed between characters and groups, when sending by flashing light, is given in the following list. Note that the interval between dits and dahs is the same.

- A dit equals 1 unit of duration.
- A dah equals 3 units.
- The period between dits or dahs in the same character equals 1 unit.
- The period between two characters equals 3 units.
- The period between groups equals 7 units.

FLASHING LIGHT QUALIFICATIONS

Certain flashing light standards are required of the Signalman for advancement to the third and second class levels. You must demonstrate your ability to meet these standards before you are recommended for advancement. They are required as part of your performance tests, which must be taken for advancement in rating.

For advancement to Signalman 3, you must be able to transmit and receive code groups at six groups per minute, and plain language messages at an approximate speed of eight words per minute. (Five characters equals one group.)

For advancement to Signalman 2, you must be able to transmit and receive code groups at an approximate speed of eight groups per minute and plain language at an approximate speed of 10 words per minute.

Following is a series of Morse code drills. Practice each drill until you can send and receive it at the rate of 25 characters per minute before going on to the next exercise. To estimate the time required to attain that speed, divide the number of characters in each drill by 25. Drill 1, for example, contains 150 characters. Before going on to drill 2, practice drill 1 until you can send or receive it in 6 minutes.

Drill 1

GM7OH	JMOHI	GOMG7	MOJG7
HOMJG	07AMG	H4OJM	7GHOJ
MJ7GM	OH1JG	OMJ4H	OG1JH
MOIGJ	HOM4G	JHJOO	GMIHJ
HIGOM	JH7G7	H07GM	J4HJG
OMGIJ	H4MOG	JGHM7	GOJMH
GGJ4O	MIJGH	4GMOG	JOGH4
OMGNI	OGM7A		

Drill 2

DOGJK	SK7MY	HMJOD	GSHKD
7M28J	YOSKH	SKDOH	MZGJK
87M0Y	MGJOH	G7S2K	DY7GO
J7MHD	SKG28	MJ7K0	G8SMR
DJH72	KYDS8	KGOMJ	SHD28
K7GO2	DKSJ4	280HY	7GKSD
HJDYM	HSK07	82GJH	DSK82
HOYMG	7D8KS		

Drill 3

EJZPH	U8IOA	YBMKW	7G085
SD3YB	KH5E5	PWJY7	JBK3H
YW7SD	EOGP5	W3BWP	ES5K2
YMOG7	HJKYO	BP827	MGSDW
KHOP3	KSJME	W7G5B	B28YD
2POHB	5SKJM	OMOG2	KYJH7
8SDW3	YBEP5	7HJG0	MYK2D
PS85P	EB3WJ	PKWGY	MJW28
HOGKS			

Drill 4

6B82H	00QP3	5T4HY	FLEWY
WEMJO	GSK3P	OHYDL	JFB6Q
FNL08	KDJ07	KMGOP	3W5BE
OKYDS	LFNGJ	YS5WN	JKOBF
POLQN	5PEDS	87HJ2	GKY3W
BQ6FO	PWO96		

Drill 5

UJKLV	AHYQP	96WX4	JO9UC
A4XQO	6LS2G	WOHPW	6F7YM
W9NSD	NGMJB	CUPEX	QKOH6
YOXC3	POH7G	5BA94	HUWEM
J28N6	QOSKY	EDLF8	X4ACU
FQ7LN	C0536	PBW5G	7HJOM
8DSKY	2DNQL	6JP9C	AW6YF
AN8PV	PW096		

Drill 6

This exercise contains all the letters of the alphabet and the 10 numerals. On completing this drill, you should be proficient in receiving all 36 characters when transmitted at the rate of 25 characters per minute.

JH7K2 YDLRI ITF9X 40WEM
JUG8S D0QZT VACU3 P0HSN
OL6B3 G02KH 7JDS8 GYMLO
B5VEF Q6N3W IZPCA UIPR9
X4JH7 2KTM0 G6SDE P5NPL
W3B80 UCTVZ 14X9B AIJPK
IFZLD YKSOQ ITRV6 N82G7
B5A9X G39PH QJMBW U4YJO
ZXGPK RVZQO J2ENU VHKPO
CZ7Y5 LAIM8 W65RI GSKE4

A single word is considered five characters. You should now be able to send or receive at the rate of five words per minute. Let's go on to drill 7 and find out whether you can.

Drill 7

Practice drill 7 until you can send or receive it in 15 minutes. By then you will have attained a solid speed of 25 characters per minute.

0 P K H V U N E 2 J O Q Z V R
K P G X Z O J Y 4 U W B M J Q
H P 9 3 G X 9 A 5 B 7 G 2 8 N
6 V R T 1 Q 0 S K Y D L Z F 1
Q P J 1 A B 9 X 4 1 Z V T C U
0 8 B 3 W L Q N 5 P E D S 6 G
0 M T K 2 7 H J 4 X 9 R P I U
A C P Z 1 W 3 N 6 Q F E V 5 B
X J 7 F 9 K T 2 Y 1 I D R L H
T 4 Z O Q U E 0 M D J S W U 8
3 V B A 6 C L U O 3 N P 5 O H
0 G L O M K Y 2 G 7 H 8 S J D
A B C 5 P V Z E 1 J W Q 3 N 6
0 U M I T P K R 2 H 7 X 4 J 9

0 G 8 B 6 S 3 D W L E Q P 5 N
Q U C T P V I Z A 1 B 4 J X 9
6 1 V F R Z T L 1 D Q Y 0 K S
0 L M Y G 8 S D J 7 H 2 O K G
3 B 6 L O N S H O P 3 U C A V
T Z Q O D S 8 G U J M E W O 4
X 9 F T I 1 R L D Y 2 K 7 H J
H 8 P 2 G 9 C 3 X 7 B 5 A 9 N
K Q P J G M X B X W O U J 4 Y
0 R P V K Z H Q O V J U 2 N E
I C R 7 2 4 Y 6 W 5 L 8 M 1 A

With 5 words per minute accomplished, we will now try to boost your speed.

Drill 8

Practice drill 8 until you can send or receive at the rate of 30 characters (6 words) per minute.

B1EF6 EQ3MY 7ADQC 31PXZ
AVDTS 61ZNA 5NTON J8SW5
BGWHG 9ZM2C 9LUF D 9PW1Y
8LD4H DK700 3UY4K 7WJVX
IZG4R 2XA0H S5Q06 RCMTV
JW7K0 1RUP0 LF8V2 MZ9GF
8LY1I X5NOP T3UHC S6B4Q
IRDZE 7QVGF UL9C4 GZIXO
Q5SHM 6ET8D IRY23 PNJWB
2V9Y4 RIN95 WFKOM EJ70X
S8L0Z 5XPUT M6CR0 N5XI4
T3Q10 2K7HP A8O0D 6BVFK
A1LUT D3HBA 2GWEC U3SQ4
Z6B7D H8AKH

Drill 9

Practice this exercise until you can send or receive 35 characters (7 words) per minute.

B2V9Y HXLB1 1HBXL 0E7YA
LIXHB 4RIN9 16NDU U1D6N
DPB1T NU6ID 5WFKO 75ZGF
F7G5Z CR2JM ZF7GH MEJ70
08THE EOH8T 04VSW TE8OH

Drill 9

**XS8LO G3UCA AGC3U Q3YKA
UA3GC Z5XPU A0YE7 7AEQY
ORVG6 PWY7T 2H9NK TD1BP
PTBDI 94NSK 1UXZR 31FQM
MCJR2 2MRCJ 2HDJL ONQRV
GSJBV WOS4V VW40S BAC31
SXTG5 YA3QK 5QEFA QK3YO
2YIF8 RCWTV Y2B9U ZP5XP
IA6Z6 APZIP XZU5I 9R4NK
2NIH9 H8L3U 3LHU8 N92KH
F0EM7 VG6SJ CM494 MK9CQ
F3MIJ 0EM7M 3QIF0 7EBWB
EOW76 JGVS8 QSXLT 8WRC0
J4LDL 40DJW C8TRD 6Z1PI
ZDP6Z P6DIP DL6S6 IPZDW
7TYPU XZ812 DLS86 D9LWP
FAW9Q XO3LA 7E0BP KJE01
P92NX IEGW2 6VQAL U8TE3
VNY75 HRE46 8OXZG OSXNM
SLD72 JWGWS QJP8E BIT4C
NCM8T R5ALF FKOVE YWNMA
70JMK**

Drill 10

Practice drill 10 until you can send or receive it in 13 minutes if you are studying for advancement to E-4, and in 10 minutes for E-5. These rates are about 8 and 10 words per minute, respectively. Drill 10 is a quotation. Remember that when you receive, you should not anticipate. The intent of the drill is to build up your solid speed.

“All persons who in time of war or of rebellion against the supreme authority of the United States come or are found in the capacity of spies or who bring or deliver any seducing letter or message from any enemy or rebel or endeavor to corrupt any person in the Navy to betray his trust shall suffer death or such other punishment as a court-martial may adjudge. If any person belonging to any public vessel of the United States commits the crime of murder without the territorial Jurisdiction thereof he may be tried by court-martial and punished with death. All persons in the naval service shall be zealous in...”

SEMAPHORE QUALIFICATIONS

LEARNING OBJECTIVES: List the semaphore characters, including special signs, position drill, the system of opposites, and unnecessary movement. List tips on learning semaphore and the qualification needed for advancement.

For advancement to Signalmans 3, you must be able to transmit and receive plain language semaphore messages at an approximate speed of 10 words per minute; and, for advancement to Signalmans 2, to transmit and receive plain language at an approximate speed of 15 words per minute.

TIPS ON LEARNING SEMAPHORE

The “semaphore expert” achieved his or her reputation as a result of PRACTICE. The only pointers we can give you is the code itself and a few helpful hints gathered from the experts to assist you in meeting and surpassing the qualifications in our rate. The semaphore alphabet isn't at all difficult to learn. The speed at which you learn to send or receive it depends on how consistently you work at it.

First of all, take a look at figure AII-2. It shows how the semaphore alphabet and certain special signals used with it are formed by using two flags. As you memorize the positions for the various letters and signals, practice moving your arms quickly and surely to each of the various positions. The person in figure AII-2 is the sender, and you are looking at the illustration as though you are the receiver.

In figure AII-3, you see a man swinging through a position drill. He moves his flags smartly to their positions, using his arms from the shoulders. The flags form an extension of the plane of his shoulders. Notice that there is no mistaking his *B* for *A* or *C*, for example. Don't try for speed at first; that will come after you master the alphabet thoroughly. A sloppy sender not only spends time repeating messages because no one can read them, but also may cause the receiver to make a mistake on a word or a code group, resulting in the message having an entirely different meaning.

A single semaphore flag may be held in eight correct positions. You can picture these positions easily if you imagine yourself standing inside a circle

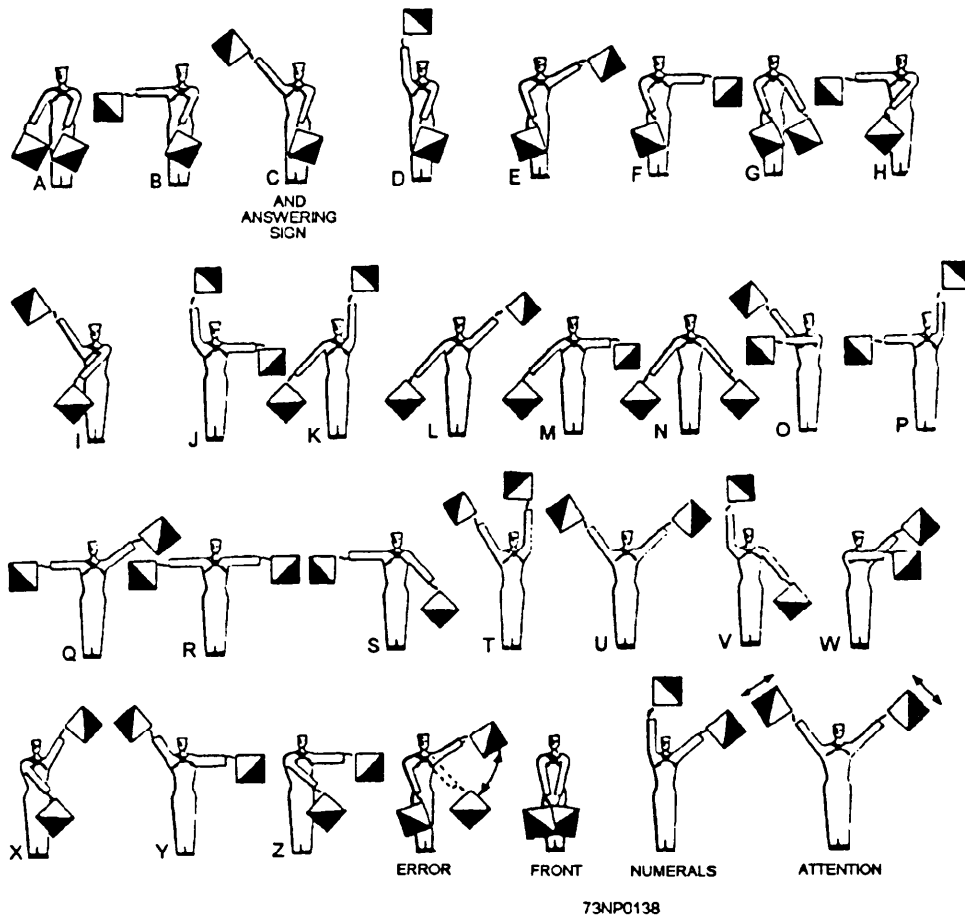

Figure AII-2.—Semaphore alphabet and special signals.

like the man in figure AII-4 Notice that the circle is divided into eight parts by equally spaced marks. These marks represent the correct flag positions. Anything between them is indefinite and will lead to confusion. Although one flag has only eight positions, innumerable combinations are possible when you use two flags as in semaphore. Of these possible combinations, 28 are used in semaphore communications. The semaphore alphabet is composed of 26 letters plus signs meaning NUMERALS and FRONT.

The FRONT sign is used after finishing a word. It is like the space left between words in ordinary writing. Also, it is used before and after each call sign, code group, operating signal, or prosign, and between all letters and numerals of a call sign. The NUMERAL sign is given just before you transmit a group of numbers or a group of mixed letters and numerals to be recorded in the text and counted as a single group. The sign is repeated when the group is completed.

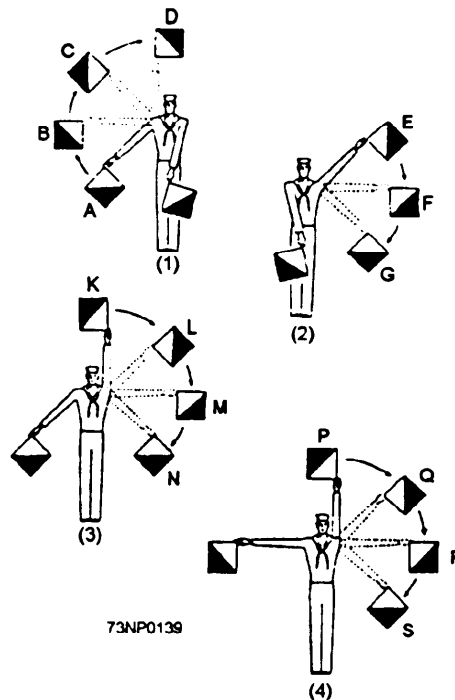

Figure AII-3.—Position drill.

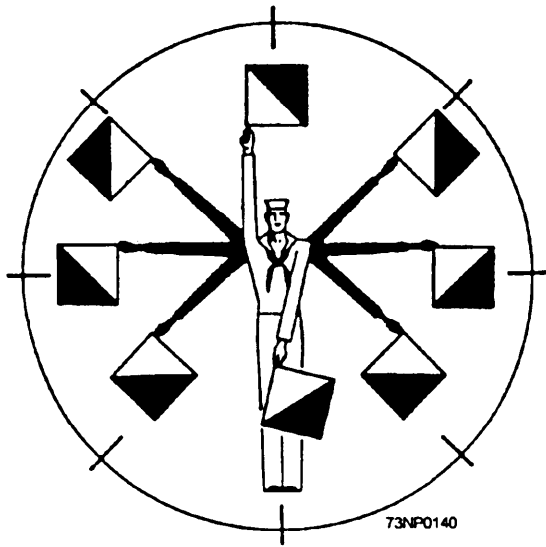

Figure AII-4.—Semaphore position circle.

Examining figure AII-2, you will see that *C* and *E* also are used as special signs. The ANSWERING sign is the same as letter *C*. The ERROR sign consists of letter *E* made eight or more times. ATTENTION is made by waving both flags from the horizontal to the overhead position.

The various instructors of semaphore in Navy schools teach different methods that they feel make learning easier. One of the most popular of these methods is the system of opposites. (See figure AII-5.) The idea here is to learn one letter, then learn a letter made by holding the hands in exactly the opposite position. Going down the list, you see that letters of the alphabet (except *L*, *D*, and *R*) have opposites that form other letters.

As you practice, move your arms from one position to another by the shortest route possible. Notice the movement of the man's arm(s) in figure AII-6 as he sends the word ships. Cutting out unnecessary movement of the arms makes your sending more uniform and increases your speed. As soon as possible, start sending and receiving with

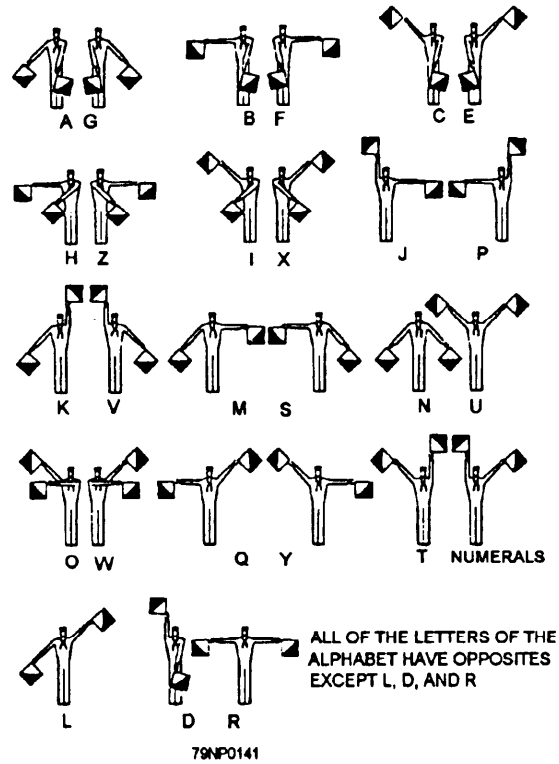

Figure AII-5.—The system of opposites

another striker. Always remember: Practicing correctly makes perfection.

The remainder of this appendix is devoted to semaphore drills for you to practice.

Drill 1

When you are able to send each letter of the alphabet easily and without hesitation, you are ready to start sending groups. Start with this exercise. Do not try for speed; that will come later.

EGMGH RILCO MUCVX LXDIR
ZKOBW MGQEH WFKZO SMGDH
QFWRK LUIVN CIJQV HJEGO
APSIJ BRSPZ PAYTD SCIVN
MGQEH LSMYZ FXNUV BRSPA

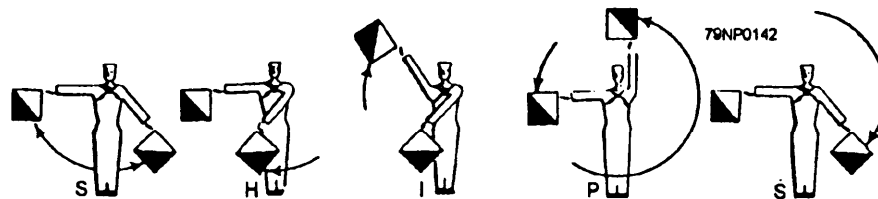

Figure AII-6.—Eliminating unnecessary movement.

Drill 2

Practice sending and receiving semaphore drill 2 using the front sign.

AGZMZ KGUGI LORPZ LAZLG
ISMFJ KOHZV CKEXQ BXQFY
FOTUB WBPYQ AYND S NAVTR
KWUGS ZECOK CHVTE LMPIB
CTEVH NCJIE VORSZ HWDNV
XQTCY RAHED GLKUM BORAX
SJXQM

Drill 3

Practice this exercise until you can send or receive at the rate of 10 groups per minute.

BQIZF ZGUZT BHM GV NBQIZ
HTEPD NKOYJ FAGLT RSKTB
MYKUC CEUDV ZQUHP MOWQE
GOJSX QTYYO ASCIQ RIPC G
VAWLR IKEJW XOJBV NRXPM
DAFJN IPURL RWAVL XOGJS
LYHSV FSCXR TEHDP JUMYC

Drill 4

Practice drill 4 until you can send or receive it without error in 5 minutes. This is a rate of 12 words per minute.

TWYJR MGLFU MFIZE DLFMS
VDKPD BIZOE AHSKD TPCNV
WSAXH HNXAW JCTGL AOGBU
ECOZB BSPKV BUONX HKOWX
UIFLM RCJYT PWVRY EZJRY
LCPND MKSGU NEDRX RJBPC
QEISV TLFVR WMAOC QKSDA
MAWHR EXHDN FQLPK ULMZI
FZTUO IWOCY SYBVJ ETNWF
XVGKY QPBZJ TIGZU VOGXH
ETKDU LFISG RWCHJ VMQNX
LAQVG MBRWH NCXSI ODTYJ
PIGWU HZJOQ VBNRC AXKSD
WBRMH XCSNI TYDOQ ZEUPK
NCXWD OEYVF PGZUG QIBTJ

Drill 5

Practice drill 5 until you can send or receive it without error in 4 minutes. When you have accomplished this, you will have attained a rate of 15 words per minute.

SCSNI YD TOJ ZEUPK AFVQL
OEYVF PGZUH QIBTJ RKASL
ODWHY PGQUJ QIATL RKSBM
LORNP MKOXC INELG JPAWQ
TFSHO KUBVH YRZSU GSJDK
GMBUF TVAQX LEMPB QLROI
JDBEI YKZHT SCBVD UWJRQ
WXLHA NPOHM SOWQR BJLTM
NVKGX GDUIK VEZFH GOCAU
OBIPB QTRVP QFUKG IYIWY
WCXAI XAYFZ QHOML EPGNY
EFQAQ FJZXD PUGWX FISKF
SDJRE JLSIR HJZMG FKASQ
MOEAM BNHMN BGQSC OIKLB
PCNHA KPDFE JLCGR PTRNI
THFYT STYEV

Drill 6

Practice drill 6 until you can send or receive it at the rate of 20 words per minute.

IFWTL PMBEV FWTLI VPMBE
DZLFG FCWRH JQUAA NWBKT
LIFWE VPMBA HLG YQ KHSVP
STCGE PKOZN ISTCG XNHRZ
STCGE PKOZN ISTCG XNHRZ
NWXAG ISUAH RSN GP LFDJA
YWUDK CGIST YPKHM EQBYD
IQYUE OTVYW TLIFB EVPMK
OPNGW RJFCU AHJQM ISFOI
QYUDP NGKOT VYELG YQHDJ
PTESF OMICL ZIESU AHISQ
ZTQGP RSNEQ NJXAG NWXUD
KYWPR SNGPH LVXXR VUCTQ
XWZRV UCXWZ TQSRU AZRZX
NHXVR TCFBM KZECL ZIAHJ
QUKAZ WB FOM ISIMI SFRJF
CWHLV XPQSW ZTBKD MOBYC

Drill 6

GMOLJ	DFDJA	LNJXE	QFGPR
WUDKY	XAGNW	KYWUD	DKYWU
JALFD	HRZYN	BYMEQ	PTEDJ
TEDJP	ZFBMK	TRCXV	CXVRT
QUAHJ	FCWRJ	BKANW	JQUAH
LIFWT	QNJXE	SNGPR	ISFOM
BMKZF	WXAGM	VPKHS	GISTC
GYSTC	TVYEO	QYUDI	VRTCX
CSXRV	DKMOB	EQBUM	LVXPH
FDOLJ	TGGIS	JFDOL	BYCGG
MBYCP	NGKOW	BKANG	KOPNC

WRJFN	WBKAM	KZFBVZ	XHNRJ
PTEDL	ZIECU	OAZRI	ECLZK
ZFBMO	AZRUE	DJPTZ	IECLM
OBDKJ	XENYQ	HLGAL	FDJMB
EVZVU	CXRGN	WXAUD	IQYAH
ISUDJ	ALFOB	DKMHI	SUAYM
EQBTC	XVRZR	UOACG	MBYXE
QNJQH	LGYNG	KOPVH	RZXDE

Drill 7

Practice sending or receiving plain-language semaphore exercise 7 until you can do it in 5 minutes, or at the rate of 20 words per minute. For this seventh drill, work on the following quotation:

“Success of communication depends primarily upon knowledge of how, when, and where to send timely and intelligible messages and can be gained only through a common understanding on the part of those directly concerned in the vital business at hand. Communication personnel have an important place in the ship's organization. Only authorized frequencies should be used by the radio organization. Care must be exercised in the choice of a code or cipher for each message. The necessity for safeguarding visual traffic must not be overlooked. The use of standard phraseology or any external indications of...”

APPENDIX III

REFERENCE LIST

Chapter 1

Communication Instructions Visual Signaling Procedure, ACP 129, Joint Chiefs of Staff, Washington, DC, 1987.

Lookout Training Handbook, NAVEDTRA 12968, Naval Education and Training Program Management Support Activity, Pensacola, FL, 1991.

Naval Telecommunication Procedures, Fleet Communication, NTP 4, Washington, DC, June 1988.

Chapter 2

Boatswain's Mate, Volume 1, NAVEDTRA 10101, Naval Education and Training Program Management Support Activity, Pensacola, FL, 1989.

Chemical Warfare Directional Detector, Technical Manual, SW073-AA-MMO-010, Commander, Naval Sea Systems Command, Washington, DC., 1985.

Infrared Transmitting Sets, Technical Manual, EE810-AA-OMI-010/82X1, Commander, Space and Naval Warfare Systems Command, Washington, DC., 1985.

Navigation and Signal Lights, Technical Manual, S9086-N2-STM- 010/CH-422 R2, Commander, Naval Sea Systems Command, Washington, DC., 1990.

Night Vision Goggles, Technical Manual, SW215-AF-MMO-010, Commander, Naval Sea System Commands, Washington, DC., 1988.

Night Vision Sight, Technical Manual, SW215-AP-MMO-010, Commander, Naval Sea Systems Command, Washington, DC., 1994.

Night Vision Sight, Technical Manual, SW215-AU-MMO-010, Commander, Naval Sea Systems Command, Washington, DC., 1995.

Ship Binoculars, Technical Manual, S9421-AA-MMA-010, Commander, Naval Sea Systems Command, Washington, DC., 1977.

Chapter 3

Communications Instructions General, ACP 121, Joint Chiefs of Staff, Washington, DC., 1983.

Communications Instructions Visual Signaling Procedure, ACP 129, Joint Chiefs of Staff, Washington, DC., 1987.

Naval Telecommunications Procedures, Fleet Communications, NTP 4, Commander, Naval Telecommunications Command, Washington, DC., June 1988.

Chapter 4

Communication Instructions General, ACP 121, Joint Chiefs of Staff, Washington, DC., 1983.

Communication Instructions Radiotelephone Procedure, ACP 125, Joint Chiefs of Staff, Washington, DC, 1987.

Communication Instructions Visual Signaling Procedures, ACP 129, Joint Chiefs of Staff, Washington, DC, 1987.

Communication Instructions, Operating Signals, ACP 131, Joint Chiefs of Staff, Washington, DC, 1986.

Naval Telecommunications Procedures, Fleet Communications, NTP 4, Commander; Naval Telecommunications Command, Washington, DC, June 1988.

Pyrotechnic Signals, ACP 168, Joint Chiefs of Staff, Washington, DC, 1979.

Chapter 5

Allied Maritime Tactical Signal and Maneuvering Book, ATP 1, Vol. II, Chief of Naval Operations, Washington, DC, 1983.

Communications Instructions Visual Signaling Procedures, ACP 129, Joint Chiefs of Staff, Washington, DC, 1987.

Naval Telecommunications Procedures, Fleet Communication, NTP 4, Commander, Naval Telecommunications Command, Washington, DC, June 1988.

Chapter 6

International Code of Signals, Pub. 102, Defense Mapping Agency Hydrographic/Topographic Center, Washington, DC, 1993.

Naval Telecommunications Procedures, Fleet Communications, NTP 4, Commander, Naval Telecommunications Command, Washington, DC, June 1988.

Chapter 7

Naval Control of Shipping Manual Guide to Masters, ATP 2, Vol. II, Chief of Naval Operations, Washington, DC, 1983.

Chapter 8

Flags, Pennants and Customs, NTP 13, Commander, Naval Telecommunications Command, Washington, DC, 1986.

International Code of Signals, Pub. 102, Director, Defense Mapping Agency Hydrographic/Topographic Center, Washington, DC, 1990.

Naval Telecommunications Procedures, Fleet Communications, NTP 4, Commander, Naval Telecommunications Command, Washington, DC, June 1988.

Pyrotechnic Signals, ACP 168, Joint Chiefs of Staff, Washington, DC 1979.

Pyrotechnic, Screening, Marking, and Countermeasures Devices, Technical Manual, SW050-AB-MMA-010, Commander Naval Sea Systems Command, Washington, DC, 1994.

Replenishment at Sea, NWP 14, Chief of Naval Operations, Washington, DC 1989.

Chapter 9

Quartermaster, NAVEDTRA 12120, Naval Education and Training Program Management Support Activity, Pensacola, FL, 1995.

U.S. Department of Transportation, *Navigation Rules International—Inland*, COMDTINST M16672.2B, Commandant, U.S. Coast Guard, Washington, DC, 1990.

Chapter 10

Flags, Pennants and Customs, NTP 13, Commander, Naval Telecommunications Command, Washington, DC, 1986.

U.S. Navy Regulations 1990, Department of the Navy, Washington DC, 1990, (Chapter 12).

Chapter 11

Department of the Navy Information and Personnel Security Program Regulation, OPNAVINST 5510.1, Department of the Navy, Washington, DC, 1988.

Chapter 12

Ship-to-Shore Movement, NWP 22-3, Office of the Chief of Naval Operations, Washington, DC, 1993.

Chapter 13

Intelligence Specialist 3 & 2, Vol. 2, NAVEDTRA 10272, Naval Education and Training Program Management Support Activity, Pensacola, FL, 1986.

Lookout Training Handbook, NAVEDTRA 12968, Naval Education and Training Program Management Support Activity, Pensacola, FL, 1991.

Navy Fact File, 9th Edition, Department of the Navy, Office of Information, Washington, DC, 1989.

Chapter 14

Naval Telecommunications Procedures, Fleet Communications, NTP 4, Commander, Naval Telecommunications Command, Washington, DC, June 1988.

Strike Warfare (STW), Antisurface Ship Warfare (ASW), Intelligence (INT), Electronic Warfare (ELW) and Command, Control and Communications (CCC) Exercises, FXP 3, Chief of Naval Operations, Washington, DC, 1987.

Surface Force Training Manual, COMNAVSURFLANT/COMNAV-SURFPACINST 3502.2a, Commander Naval Surface Force, Atlantic Fleet, Norfolk, VA; Pacific Fleet, San Diego, CA, 1993.

INDEX

A

Accounting and control, 11-14
Afloat salvage operations, 12-23
Aids to navigation, 9-7
 aids in intracoastal waterway, 9-19
 buoys, 9-11
 cardinal marks, 9-16
 daybeacons/daymarks, 9-15
 fog signals, 9-19
 isolated danger marks, 9-17
 lateral marks, 9-15
 light characteristics, 9-7
 light visibility, 9-8
 lighthouses and light structures, 9-9
 lights, 9-7
 lightships, 9-10
 maritime buoyage system, 9-11
 new danger, 9-19
 ranges, 9-19
 safe-water marks, 9-18
 sector lights, 9-10
 special marks, 9-18
Aircraft identification, 13-1
 aircraft types, 13-1
 aircraft measurements, 13-1
 helicopter identification, 13-3
 identification aids, 13-2
Allied maritime tactical signal and maneuvering
 book, 5-7
 basic maneuvering flags, 5-9
 bearing, direction, distance, 5-13
 constructing flaghoist signals, 5-8
 emergency signals, 5-13
 single flags and pennants, 5-13
 substitutes, 5-11

 Allied maritime tactical signal and maneuvering
 book—Continued

 time zone, 5-12
 times and dates, 5-11
 unit of reference, 5-11

Amphibious duties, 12-1

Amphibious flags, lights, markers, and signals,
12-10

 beach flags and panels, 12-10
 boat team paddles, 12-13
 flag requirement, 12-10
 low-visibility signals, 12-13
 signal or marker lights, 12-13

Amphibious operations, 12-1

Amphibious ships and crafts, 12-1

 assault ship, 12-2
 command ship, 12-1
 general-purpose assault ship, 12-1
 landing craft, 12-2
 landing ship, 12-2
 multipurpose assault ship, 12-1
 transport dock, 12-1

B

Boatcrew signalman, 8-12

 directing boat by visual signals, 8-12

Boat flag display, 10-12

 boat hails, 10-13
 flagstaff topping ornament, 10-13
 personal flag and pennants, 10-6

C

Chemical warfare directional detector, 2-8

 installation, 2-10
 maintenance, 2-10
 training, 2-10

- Clearances, 11-4
 - access, 11-6
 - eligibility, 11-5
 - interim and final, 11-6
 - types of investigations, 11-5
 - Colors, 10-11
 - Communications publications, 1-5
 - communications feedback report, 1-6
 - correction and changes, 1-6
 - obtaining publications, 1-6
 - Compromises and security violations, 1-14
 - Control organization, 12-8
 - assistant boat group commander, 12-10
 - assistant central control officer, 12-9
 - boat group commander, 12-9
 - boat wave commander, 12-12
 - central control officer, 12-9
 - primary control officer, 12-9
 - secondary control officer, 12-9
 - wave guide officer, 12-10
 - Convoy communications, 7-1
 - Civil Direction of Shipping Organization, 7-1
 - command and responsibility, 7-3
 - convoy commodore, 7-3
 - Naval Control of Merchant Shipping, 7-1
 - Naval Control of Shipping in war, 7-3
 - Naval Control of Shipping Officer, 7-2
 - Naval Control of Shipping Organization, 7-1
 - officer in tactical command, 7-3
 - operational control authority, 7-1
 - rear commodore, 7-4
 - vice commodore, 7-4
 - voluntary naval control of shipping, 7-2
 - Convoy communications instructions, 7-7
 - call sign, 7-7
 - communications plan, 7-9
 - executive messages, 7-8
 - flag signaling, 7-8
 - Convoy communications instructions—Continued
 - flashing light, 7-8
 - man overboard, 7-10
 - master's communications responsibility, 7-9
 - maneuvering signals, 7-9
 - port examination flag, 7-10
 - pyrotechnics, 7-8
 - radiotelegraph, 7-9
 - radiotelephone, 7-7
 - ship/shore transmissions, 7-9
 - signals used in convoy, 7-9
 - time, 7-10
 - Convoy conferences, 7-10
 - communication conferences, 7-10
 - Signalman conference, 7-10
 - Convoy formation, 7-4
 - call sign, 7-6
 - change of guide, 7-6
 - column and lane numbering, 7-5
 - grid system, 7-4
 - guide, 7-6
 - light-repeating ships, 7-6
 - taking up formation, 7-7
- D**
- Debarkation, 12-4
 - areas, 12-4
 - control area, 12-6
 - identification of stations, 12-7
 - procedures for calling alongside, 12-7
 - well deck/tank deck, 12-8
 - Declassification, downgrading, and upgrading, 11-14
 - notification, 11-14
 - transferred material, 11-14
 - Destruction of classified material, 11-16
 - emergency destruction, 11-17
 - methods of emergency destruction, 11-18
 - reporting emergency destruction, 11-18

- Disposition of classified material, 11-15
- Dissemination, 11-16
 - distribution, 11-16
 - of Secret and Confidential material, 11-16
 - of Top Secret material, 11-16
- Dress and full-dress, 10-11
- Drills and exercises, 14-1
 - critiques, 14-1
 - communications evaluations, 14-2
 - communications plan, 14-3
 - comprehensive communications assessment, 14-3
 - grading, 14-2
 - security, 14-2
 - visual communications (CCC-15-SF through CCC- 17-W), 14-2
 - wartime provisions for visual signaling, 14-3
- Duties to perform, 1-2
 - boat Signalman, 1-5
 - expert lookout, 1-5
 - flag bag operator, 1-4
 - in-port duty Signalman, 1-5
 - searchlight operator, 1-5
 - semaphore operator, 1-5
 - Signalman of the watch, 1-5
 - Signalman supervisor, 1-5
 - spotter, 1-5
- E**
- Emergency signals, 8-10
 - aircraft emergencies, 8-10
 - ship emergencies, 8-11
 - submarine emergencies, 8-11
- Energizing equipment, 1-7
- F**
- Flag display, 10-1
 - dipping, 10-5
- Flag display—Continued
 - half-masting, 10-3
 - hoisting and lowering, 10-3
 - national ensign, 10-2
 - union jack, 10-6
- Flaghoist procedures, 5-13
 - answering and acknowledging, 5-13
 - canceling a signal, 5-14
 - correcting a signal, 5-14
 - expediting, 5-14
 - relaying, 5-15
- Flaghoist terminology, 5-4
 - flag bag operator, 5-5
 - flaghoist essentials, 5-5
 - hauling down signals, 5-6
 - hoisting signals, 5-4
 - reading flaghoist, 5-5
- Flags and halyards, 2-20
 - care of flags, 2-20
 - care of halyards, 2-21
 - flag nomenclature, 2-20
 - going aloft, 2-27
 - halyards, 2-2 1
 - repair of flags, 2-21
 - splicing double-braided line, 2-2 1
- Flags of maritime nations, 10-23
- Flashing light procedure, 4-4
 - answering and receipting, 4-5
 - calling, 4-5
 - communications with aircraft, 4-9
 - correction and repetition, 4-6
 - direction al procedure, 4-4
 - executive method, 4-8
 - infrared communications, 4-10
 - nondirectional, 4-4
 - relaying instructions, 4-6

Flashing light procedure—Continued

- special procedures, 4-6
- use of signal light, 4-4
- verification, 4-8

G

General communications procedure, 4-1

- operating signals, 4-1
- operator's responsibility, 4-3
- visual procedure, 4-3
- visual relay responsibility, 4-2

Grid reference system, 12-18

- before debarkation, 12-18
- communications circuit, 12-20
- quite-landing procedure, 12-22
- rendezvous area, 12-18
- transmitting visually, 12-21

H

Honors, 10-14

- foreign officer and civil official, 10-18
- official visit, 10-10
- official inspection, 10-18
- passing, 10-14
- relief of command, 10-17
- side, 10-16

I

In-port duty Signalman, 8-15

- absentee pennant, 8-15
- colors, 8-15
- visual watch, 8-15

Incoming message procedure, 3-17

Infrared communication equipment, 2-6

- AN/SAT 2 transmitting set, 2-6

International signaling, 6-1

- definitions, 6-1

International signaling—Continued

- distress and lifesaving signals, 6-12
- flag signaling, 6-4
- flashing light, 6-6
- general medical code, 6-10
- general remarks, 6-1
- index, 6-19
- medical signal code, 6-11
- method of signaling, 6-2
- Morse signaling by hand flags or arms, 6-8
- radiotelephone, 6-8
- signaling instructions, 6-1
- single-letter signals, 6-8
- single-letter signals with compliments, 6-10
- sound signaling, 6-7
- U.S. and Russia supplementary signals, 6-16

L

Logs and files, 8-5

- classified material, 8-9
- communications center master file, 8-7
- cryptocenter file, 8-7
- general message file, 8-7
- visual communications log, 8-5
- visual station file, 8-6
- watch-to-watch inventory, 8-8

Lookout duties, 8-4

- dark adaptation, 8-5
- night vision, 8-5

M

Maintenance and material management, 2-28

Making up a flag for the break, 5-15

Merchant ship identification, 13-19

- appearance group, 13-19
- bow and stern, 13-24
- hull types, 13-19

Merchant ship identification—Continued
identification procedures, 13-19
sequence of upright, 13-22

Miscellaneous flags and pennants, 10-18
absentee pennants, 10-21
award flags and pennants, 10-21
church and jewish worship, 10-21
homeward-bound pennant, 10-20
pow/mia, 10-21
red cross, 10-21
United Nations flag, 10-18
U.S. Navy flag, 10-18
Multipurpose signal light, 2-5

N

Naval message format, 3-2
abbreviated plaindress message, 3-10
codress message, 3-10
plaindress message, 3-3
service message, 3-10

Navigational charts and publications, 9-3
chart issue, 9-6
chart scales, 9-5
chart sounding marks, 9-6
hand corrections, 9-7
locating positions on charts, 9-3
notice to mariners, 9-6

Navigational equipment, 9-1
bearing and azimuth circle, 9-2
compasses, 9-1
telescopic alidades, 9-3

Night vision devices, 2-14
AN/PVS-8, 2-16
AN/PVS-11 pockscope, 2-19
AN/PVS-5 night vision goggles, 2-17
general safety precautions, 2-19
Mk 37 night vision sight, 2-14

O

Operation orders and plans, 14-4
operation orders, 14-4
operations plans, 14-4

Optical equipment, 2-10
binoculars, 2-13
care of optics, 2-13
ship's binoculars, 2-11

Originating messages, 3-1
address of messages, 3-2
drafter, 3-1
originator, 3-1
releasing officer, 3-1
types of messages, 3-1

P

Parts of a flaghoist message, 5-16
heading, 5-6
text, 5-7

Personal flags and command pennants, 10-6
afloat display, 10-6
aircraft, 10-10
ashore display, 10-10
broad and burgee command, 10-9
commission pennant, 10-10
display of two simultaneously, 10-9
restrictions, 10-7
size of personal flags and command pennants, 10-9
vehicles, 10-10

Prosigns, 3-2

Pyrotechnics, 4-12

R

Radiotelephone, 4-13
beadwindow, 4-22
circuit log, 4-14
executive method, 4-22

Radiotelephone—Continued

- general procedures, 4-16
- messages, 4-21
- numerals, 4-16
- phonetic alphabet, 4-15
- prowords, 4-16
- radio net, 4-14
- security, 4-14

Recording messages, 1-2

- lettering, 1-3
- message blank, 1-4
- phonetic alphabet, 1-3

Rules of the road, 9-20

- lights and shapes, 9-22
- sound signaling in restricted visibility, 9-28
- steering and sailing rules, 9-20

S

Safeguarding, 11-11

- restricted area, 11-11
- security checks, 11-12
- working hours, 11-11
- working spaces, 11-13

Security, 11-1

- command management, 11-1
- education, 11-2
- principles, 11-2
- purpose, 11-1

Security classification, 11-2

- Confidential, 11-3
- markings, 11-3
- Secret, 11-3
- Top Secret, 11-2

Semaphore procedures, 4-10

- calling, 4-11
- executive method, 4-12
- interruptions, 4-12

Semaphore procedures—Continued

- numerals, 4-11
- receipting, 4-11
- relay, 4-12
- repetitions, 4-12
- special characters, 4-11
- special semaphore abbreviations, 4-1 1

Ship identification, 13-5

- amphibious ships, 13-7
- auxiliary, 13-9
- combatants, 13-6
- minor combatants, 13-6
- surface ships, 13-6

Signal bridge, 1-2

- getting oriented, 1-2
- military appearance, 1-2

Signal flags and pennants, 5-1

Signal searchlight, 2-1

- 12-inch modified mercury-xenon searchlight, 2-3
- 12-inch mercury-xenon arc searchlight, 2-2
- 12-inch incandescent, 2-1

Sound signaling, 4-12

- executive method, 4-13
- identification of ships, 4-13
- limitations, 4-13
- receipting, 4-13

Special convoy flags, 7-4

- commodore's flag, 7-4
- convoy flag, 7-4
- guide flag, 7-4

Standing orders, 14-3

- standing orders sample, 14-5

Station and address designators, 3-11

- address groups, 3-16
- call signs, 3-11
- plain language and address designators, 3-17

- Storage, 11-7
 - combinations, 11-8
 - keys, 11-10
 - new container, 11-8
 - non-approved container, 11-8
 - repairing, 11-10
 - securing, 11-10
- Storm warning signals, 8-15
- Submarine identification, 13-15
 - coding system, 13-15
 - recognition features, 13-6
 - type of submarines, 13-18
- T**
- Technical administration, 14-1
- U**
- Underway replenishment, 8-16
 - communications alongside, 8-20
 - distance markers, 8-18
 - replenishment procedures, day, 8-17
- Underway replenishment—Continued
 - replenishment procedures, night, 8-18
 - replenishment signals, 8-17
 - ships involved, 8-16
 - transfer station markers, 8-18
- V**
- Visual communications, 1-1
- W**
- Watch duties, 8-1
 - locating ships in formation, 8-3
 - messenger/recorder, 8-3
 - signal supervisor, 8-1
 - spotter, 8-3
- Waterborne ship-to-shore movement, 12-4
 - execution, 12-4
 - final preparations, 12-4
 - positioning, 12-4
- Y**
- Yardarm blinkers, 2-6

Assignment Questions

Information: The text pages that you are to study are provided at the beginning of the assignment questions.

ASSIGNMENT 1

Textbook Assignment: "Introduction to Visual Communications" and "Signal Equipment," chapters 1 and 2, pages 1-1 through 2-8.

- 1-1. The communications organization aboard ship is under the control of what officer?
1. Communications officer
 2. Commanding officer
 3. Signal officer
 4. Flag officer
- 1-2. The Signalman PQS booklet contains the fundamentals, systems, and watchstations recognized by CNET as the minimum qualification for whom?
1. Signalman supervisor
 2. Signal officer
 3. Communications officer
 4. Signalman striker
- 1-3. The planning, organization, and training that goes into the makeup of a signal gang is designed for what reason?
1. To assist the Signalman in knowing his/her duties
 2. To assign responsibilities
 3. To perfect the Signalman's ability to transmit and receive messages vital to the operation of the ship
 4. To perfect the Signalman's ability to operate the ship during a communications exercise
- 1-4. Aboard some ships, your duties may include navigation in addition to your visual signaling duties.
1. True
 2. False
- 1-5. Aboard ship, all visual signals are made from what area?
1. The flag bridge
 2. The navigation bridge
 3. The signal bridge
 4. The flying bridge
- 1-6. What is the main consideration in the location of signal bridges?
1. Manpower availability
 2. Space availability
 3. Ship superstructure
 4. Ship to horizon visibility
- 1-7. During daylight, what method of communication do force commanders usually use to maneuver their formations?
1. Radio
 2. Semaphore
 3. Flashing light
 4. Flaghoist
- 1-8. As a Signalman, you should become familiar with which of the following spaces?
1. Signaling spaces
 2. Departmental spaces
 3. Engineering spaces
 4. All of the above
- 1-9. What spaces aboard ship should be the cleanest and most orderly?
1. The spaces in which you work
 2. The spaces in engineering
 3. The spaces in navigation
 4. The spaces in deck division
- 1-10. After joining the signal gang, what will probably be your first duty?
1. Transmitting visual messages
 2. Receiving visual messages
 3. Recording visual messages
 4. Logging visual messages

- 1-11. Of the 26 letters of the phonetic alphabet, a total of how many have a word equivalent?
1. 20
 2. 25
 3. 26
 4. 17
- 1-12. The phonetic alphabet is used in naval communications for which of the following reasons?
1. To improve the sound
 2. To avoid mistaking letters that sound alike
 3. To translate messages with foreign navies
 4. To help Signalmen remember the alphabet
- 1-13. As a spotting Signalman, how do you call out the time for a signal that directs your ship to communicate by flaghoist, starting at 1830?
1. WUN AIT TREE OH
 2. WUN AIT THIRTY
 3. WUN AIT TREE ZERO
 4. EIGHTEEN THIRTY
- 1-14. Why should you insert a bar through the letter **Z** when recording a message?
1. So the letter cannot be mistaken for the digit 2
 2. So the letter cannot be mistaken for a lowercase letter
 3. So the letter looks better
 4. So the letter cannot be mistaken for the flash precedence sign
- 1-15. The horizontal bar beneath the digit 1 is placed there to distinguish it from the letter I.
1. True
 2. False
- 1-16. When you are forming letters and numerals, which of the following combinations can NOT be written with a straight line?
1. G, D, Q, 7
 2. R, J, P, 3
 3. C, O, S, 6
 4. A, F, U, 5
- 1-17. Of the following tasks, which one is NOT required to become a signal bridge spotter?
1. Reading flaghoist
 2. Knowing flaghoist terminology
 3. Recognizing all flags
 4. Determining the meaning of the signal
- 1-18. When communicating by Morse code, you should use what method of visual communications?
1. Semaphore
 2. Flaghoist
 3. Flashing light
 4. Panel signaling
- 1-19. For what reason is semaphore better adapted for long messages?
1. It is less tiresome
 2. It is faster
 3. It is more reliable
 4. It is more secure
- 1-20. What series of publications is known as the communications instructions group?
1. JANAP/ACP 100 through 112
 2. JANAP/ACP 113 through 119
 3. JANAP/ACP 121 through 134
 4. JANAP/ACP 136 through 150
- 1-21. Visual communications procedures are found in what publication?
1. ACP 112
 2. ACP 125
 3. ACP 129
 4. ACP 131
- 1-22. What is the classification of the Allied Maritime Tactical Signal and Maneuvering book?
1. CONFIDENTIAL
 2. SECRET
 3. NATO RESTRICTED
 4. FOUO

1-23. What publication contains information on all matters concerning flags and pennants?

1. ACP 121
2. ACP 129
3. NTP 4
4. NTP 13

1-24. Information pertaining to operating signals is found in what publication?

1. ACP 121
2. ACP 131
3. NTP 3
4. PUB 102

1-25. Information pertaining to joint voice call signs is found in what publication?

1. JANAP 119
2. NTP 3
3. NTP 4
4. ACP 113

QUESTIONS 1-26 THROUGH 1-28 PERTAIN TO

1-26. What action must be taken immediately after new pages have been inserted in a publication?

1. Check all pages
2. Return it to the publications custodian
3. Turn it in to the leading Signalman
4. Lock it in a secure container

1-27. When you are entering pen and ink corrections what color ink should NEVER be used?

1. Black
2. Red
3. Blue
4. Green

1-28. When you have a cutout correction for a publication, what should you do with the superseded portion?

1. Destroy it
2. Delete it with pen and ink
3. Turn it in to the commanding officer
4. Turn it in to the leading Signalman

1-29. What type of communication is used to submit recommended changes to NTPs?

1. A letter
2. A newsgram
3. A feedback report (FBR)
4. A memo

1-30. Where is the signal and anchor light supply and control panel located?

1. On the signal bridge
2. In the signal shelter
3. In the navigation office
4. In the pilothouse

1-31. The not-under-command lights are fitted with a crank handle to facilitate pulsating for what reason?

1. Restricted movement
2. Man overboard
3. UNREP lights
4. Navigation lights

1-32. Before standing your first watch aboard a ship, you should explore the signal bridge and conning station for what purpose?

1. To practice semaphore signaling
2. To determine the location of signal equipment switch panels
3. To ascertain the location of the flag bag
4. To prepare yourself for receiving flashing light messages

1-33. Which of the following signal gear is used in the directional method of visual communication?

1. Flaghoist
2. Yardarm blinkers
3. Semaphore
4. Signal searchlight

QUESTIONS 1-34 THROUGH 1-45 PERTAIN TO THE 12-INCH INCANDESCENT SEARCHLIGHT.

- 1-34. What part of the searchlight assembly is designed to allow the light to be swung in an arc?
1. The housing drum
 2. The lamp-supporting yoke
 3. The brace between the mounting bracket and the yoke
 4. The extension between the drum and the locking clamp
- 1-35. What size watt lamp is used in the 12-inch incandescent searchlight?
1. 500
 2. 1,000
 3. 1,500
 4. 2,000
- 1-36. The trunnion bearings permit what action?
1. Removal of the drum from the yoke
 2. Movement of the drum in train
 3. Adjustment of the light so it can be elevated or depressed
 4. Adjustment of the drum in bearing
- 1-37. At night, how should you train your searchlight on the receiver?
1. Directly on the receiver
 2. Slightly under or above the receiver
 3. To the left of the receiver
 4. To the right of the receiver
- 1-38. How are the signaling shutters protected from damage?
1. By using a smooth, easy motion
 2. By slowly releasing the shutters
 3. By two leather bumpers
 4. By the hinge arrangement of the shutters
- 1-39. When not in use, the searchlight should be locked in what position?
1. Fore and aft
 2. Face up
 3. Face down
 4. Inboard
- 1-40. What type of maintenance is performed on the searchlight when the ship is going through an overhaul?
1. Start-up maintenance
 2. Weekly maintenance
 3. Quarterly maintenance
 4. Lay-up maintenance
- 1-41. How often should the electrical leads of searchlights be checked?
1. Daily
 2. Weekly
 3. Monthly
 4. Yearly
- 1-42. For what reason is the searchlight operated a few minutes after lubrication with the glass door and cover removed?
1. To reduce clouding of the reflectors
 2. To allow the lubricant to evaporate
 3. To make sure the searchlight is working properly
 4. To make sure no one uses the searchlight too soon after lubrication
- 1-43. For what reason should the two shutter stop screws be adjusted at regular intervals?
1. To take up wear in the leather bumpers
 2. To prevent bending of the shutters
 3. To keep the shutters open
 4. To keep the shutters closed
- 1-44. At least how often should the reflector be cleaned?
1. As required by your leading Signalman
 2. As required by the communications officer
 3. Monthly
 4. Quarterly and/or when needed
- 1-45. Who normally replaces the lamp and focuses the searchlight?
1. The Signalman
 2. The Opticalman
 3. The IC Electrician
 4. The Electrician's Mate

QUESTIONS 1-46 THROUGH 1-59 PERTAIN TO THE 12-INCH MERCURY-XENON AND MODIFIED MERCURY-XENON ARC SEARCHLIGHTS.

- 1-46. When the main arc is established, the voltage of the primary transformer drops to a minimum of how many volts?
1. 45
 2. 55
 3. 65
 4. 75
- 1-47. What is the purpose of five resistors connected in parallel?
1. To limit the current at starting and during operations
 2. To keep the searchlight operational
 3. To keep the light level
 4. To shut the light off if the voltage is too high
- 1-48. The increase in light intensity greatly increases which of the following conditions?
1. Brilliance
 2. Range
 3. Voltage
 4. Radiation
- 1-49. After the mercury-xenon lamp arcs, you must return the starter switch to the START position to make sure that the required starting current does NOT cause what damage to occur to the light?
1. Decreased intensity
 2. Arc too soon
 3. Electrical components malfunction
 4. Explosion
- 1-50. Approximately how long does it take the lamp to reach maximum brilliance?
1. 2 to 3 min
 2. 3 to 4 min
 3. 4 to 5 min
 4. 5 to 6 min
- 1-51. Because the life of the lamp is reduced considerably at extreme angles, the light should NOT be depressed or elevated more than how many degrees for extended periods of time?
1. 5°
 2. 10°
 3. 20°
 4. 30°
- 1-52. When lighting off the lamp, when should you release the start switch?
1. When maximum brilliance is reached
 2. When you have finished communicating
 3. When approximately 5 minutes has elapsed
 4. When the lamp arcs
- 1-53. What may result if oil or grease comes in contact with the lamp?
1. The brilliance will decrease
 2. The brilliance of the lamp will increase
 3. The quartz lamp shell may explode
 4. The glass lamp may crack
- 1-54. What agent is the best to use to clean a soiled lamp?
1. Soap and water
 2. Polish
 3. Light oil
 4. Alcohol or other grease-free solvent
- 1-55. Which of the following maintenance procedures requires the use of gloves and a face shield?
1. Replacing the lamp
 2. Adjusting the beam
 3. Lubricating the shutters
 4. Operating the searchlight
- 1-56. What happens to a mercury-xenon lamp that has reached the end of its usefulness?
1. It is turned in to the nearest naval installation
 2. It is smashed beyond recognition
 3. It is turned over to the mercury-control officer
 4. It is incinerated

- 1-57. When you are installing a new mercury-xenon lamp, the longer of the two leads should be pointing in what direction?
1. Right
 2. Left
 3. Up
 4. Down
- 1-58. If the light beam is aimed too high or too low, what screw should you adjust to correct the problem?
1. The vertical adjustment
 2. The horizontal adjustment
 3. The focusing adjustment
 4. The beam adjustment
- 1-59. When the light beam is off-centered, what
1. Center the transverse sliding plate
 2. Manipulate the focusing handle
 3. Apply even pressure to the horizontal screws
 4. Center the lamp
- 1-60. The multipurpose signal light needs a total of how many batteries to operate?
1. One
 2. Two
 3. Three
 4. Four
- 1-61. What is the effective range, in yards, of the multipurpose signal light?
1. 1,000
 2. 2,000
 3. 3,000
 4. 4,000
- 1-62. The multipurpose light is designed to send a total of how many words per minute?
1. 10
 2. 12
 3. 14
 4. 16
- 1-63. Yardarm blinkers are what point white lights?
1. 12
 2. 22
 3. 32
 4. 35
- 1-64. A flashing-light message sent simultaneously to all ships in company probably would be transmitted by what means?
1. A 24-inch searchlight
 2. A 12-inch searchlight
 3. A multipurpose searchlight
 4. Yardarm blinkers
- 1-65. What signaling equipment requires a special receiving device?
1. Xenon
 2. Infrared
 3. Incandescent
 4. Multipurpose
- 1-66. In what frequency range (of the electromagnetic spectrum) is the AN/SAT 2 designed to transmit signals?
1. 0.75 to 1.2 microns
 2. 0.80 to 1.5 microns
 3. 0.85 to 1.2 microns
 4. 0.90 to 1.2 microns
- 1-67. The AN/SAT 2 beacons are designed so they can NOT be detected past a threshold distance of how many yards?
1. 100
 2. 200
 3. 300
 4. 400
- 1-68. What watt bulb is housed in the AN/SAT 2 dome-shaped homogeneous tempered glass filter?
1. 100
 2. 200
 3. 300
 4. 400

- 1-69. When you are using the AN/SAT 2, what device permits steady operation of the beacons?
1. The hold-down lever
 2. The locating pins
 3. The hold operation switch
 4. The capacitor
- 1-70. What attachment is necessary to convert a 12-inch searchlight for the signaling of directional infrared?
1. A hood containing a special filter lens
 2. An incandescent lamp
 3. An image converter tube
 4. A battery power pack
- 1-71. What system provides U.S. Navy ships with the capability for detecting and identifying chemical warfare agents?
1. AN/KAS-1
 2. AN/SAR-7
 3. Mk 37
 4. Mk 36
- 1-72. The AN/KAS-1 is designed to specifically detect what chemical warfare agent?
1. Blood
 2. Blister
 3. Nerve
 4. Choking
- 1-73. In what background area is chemical warfare detection least effective?
1. The sky
 2. The water
 3. On land
 4. In darkness
- 1-74. The detection of personnel on the water surface can be determined by the chemical warfare directional detector.
1. True
 2. False
- 1-75. Which of the following is NOT provided with the AN/KAS-1 sensor kit?
1. Power conversion unit
 2. Pivot mount
 3. Carriage assembly
 4. Maintenance kit

ASSIGNMENT 2

Textbook Assignment: "Signalman Equipment," chapter 2 (continued), pages 2-8 through 2-28.

- 2-1. The filter wheel switch allows the operator to rotate the wheel a total of how many positions in the optical chain?
1. One
 2. Two
 3. Three
 4. Four
- 2-2. What is the power source of the power conversion unit?
1. 115-Vac 60 Hz
 2. 120 volts
 3. A D-cell battery
 4. A nickel-cadmium battery
- 2-3. What part of the chemical warfare directional detector consists of an electronics tray contained in a watertight protective housing?
1. The sensor unit
 2. The pivot mount
 3. The power conversion unit
 4. The maintenance kit
- 2-4. The chemical warfare directional detector should be purged once every how many days?
1. 10
 2. 20
 3. 30
 4. 40
- 2-5. When the chemical warfare directional detector is installed, a total of how many locations should be established for each detector?
1. One
 2. Two
 3. Three
 4. Four
- 2-6. The eyepiece magnification of the ship's binoculars is what power?
1. 10X
 2. 16X
 3. 20X
 4. 32X
- 2-7. The ship's binoculars focusing knob enables the diopter scale to be increased in what increments?
1. 1/10
 2. 1/5
 3. 1/3
 4. 1/2
- 2-8. What device(s) is/are used to evacuate and recharge the binoculars assembly with dry nitrogen?
1. The inlet and outlet valves
 2. The increase-density control
 3. The carriage assembly
 4. The binoculars assembly level
- 2-9. What assembly is used to mount the ship's binoculars to the deck?
1. The binoculars assembly
 2. The carriage assembly
 3. The elevation handle assembly
 4. The pedestal assembly
- 2-10. Ship's binoculars should be inspected at least how often to make sure they are in good working order?
1. Daily
 2. Weekly
 3. Monthly
 4. Yearly

- 2-11. What is the most commonly used optical equipment?
1. The ship's binoculars
 2. The long glass
 3. The 7x50 binoculars
 4. The OOD's spyglass
- 2-12. What is the best optical equipment to use when tracking a fast-moving target?
1. The long glass
 2. The ship's telescope
 3. The ship's binoculars
 4. The 7x50 binoculars
- 2-13. What is the first step in focusing a pair of binoculars?
1. Set the left eyepiece on zero and the right eyepiece on 4
 2. Set both eyepieces on zero
 3. Set both eyepieces on 1
 4. Set both eyepieces on 4
- 2-14. What adjustment method is used to obtain the proper focus of the binoculars?
1. Keep both eyes open while adjusting one eyepiece with both lenses uncovered
 2. Keep both eyes open while adjusting one eyepiece at a time with the opposite lens covered
 3. Adjust both eyepieces at the same time
 4. Adjust one eyepiece at a time while keeping the other eye closed
- 2-15. Assume that your focus setting for day use of the binoculars is 3 for the left eye and 4 for the right eye. With the same binoculars, what should be your night focus setting?
1. 3 left and 3 right
 2. 2 left and 3 right
 3. 1 left and 2 right
 4. 4 left and 4 right
- 2-16. Which of the following items should you use to clean the glass of optical equipment?
1. Cheesecloth
 2. Lens paper
 3. A soft cloth moistened with alcohol
 4. A soft cloth moistened with any grease-free solvent
- 2-17. Repeated cleaning of a lens, no matter how careful you are, eventually damages the lens.
1. True
 2. False
- 2-18. The optics used in night vision devices are of what type?
1. Magnetic
 2. Prismatic
 3. Fluorescent
 4. Electronic
- 2-19. Which of the following is NOT a function of night vision devices?
1. To observe friendly forces
 2. To detect enemy movement
 3. To scan an area accurately
 4. To detect nerve agents
- 2-20. A total of how many glass elements are contained in the eyepiece assembly of the Mk 37?
1. Five
 2. Six
 3. Seven
 4. Eight
- 2-21. What part of the eyepiece assembly of the Mk 37 night vision sight allows the operator to use both eyes?
1. The monocular lens
 2. The rubber eyeshield
 3. The binoculars eyepiece lens
 4. The 8.6X lens

- 2-22. What is the shelf life of the BA 1100/U 6.8-volt disposable mercury battery supplied with the Mk 37 night vision sight?
1. 1 yr
 2. 2 yr
 3. 3 yr
 4. 4 yr
- 2-23. The AN/PVS-8 uses a mounting system common to what piece of equipment?
1. ANKAS-1
 2. AN/PVS-11
 3. Ship's binoculars
 4. Mk 37
- 2-24. Power for the AN/PVS-8 is provided by what source?
1. 115-Vac 60 Hz
 2. Two 1.5V D-cell batteries
 3. Two 1.5V AA batteries
 4. One 6V battery
- 2-25. When you are using night vision goggles, illumination for close-up work when ambient light is low is provided by what means?
1. Infrared light source
 2. Light emitting surfaces
 3. Fluorescent light
 4. A flashlight
- 2-26. What is the weight, in ounces, of night vision goggles?
1. 10
 2. 22
 3. 26
 4. 32
- 2-27. What is the adjustable range of the eyepiece of night vision goggles?
1. 1 to -6
 2. 2 to -6
 3. 3 to -6
 4. 4 to -6
- 2-28. What part of night vision goggles allows for the binoculars assembly to be moved within the frame for eye relief and comfort?
1. The objective lens
 2. The clamp lever
 3. The monocular assembly
 4. The eye relief adjustment
- 2-29. What operating phase of the night vision goggles includes releasing the air pressure, releasing the latches, ensuring that the rotary switch is in the OFF position, and inserting the battery?
1. The test operating phase
 2. The post operation phase
 3. The preoperation phase
 4. The beginning phase
- 2-30. What operating phase of night vision goggles includes positioning the rotary switch to the ON position, loosening the lever clamp, adjusting the goggles for proper spacing, and adjusting the diopter ring?
1. The beginning phase
 2. The pretest phase
 3. The test operating phase
 4. The post operating phase
- 2-31. What should be done when any part of night vision goggles, other than the parts authorized for replacement, become defective or missing?
1. Replacement goggles should be requisitioned
 2. They should be turned in to the commanding officer
 3. Scheduled maintenance should be done
 4. The missing or defective part should be ordered
- 2-32. Night vision sights can NOT be harmed during nighttime operations if they are pointed at a bright light for extended periods of time.
1. True
 2. False

2-33. What magnification lenses are provided with the AN/PVS-11?

1. 1X and 3X
2. 3X and 5X
3. 3.5X and 6X
4. 10X and 20X

2-34. The AN/PVS-11 is provided with an IR source for what purpose?

1. Signaling
2. Close-up viewing
3. To allow training of other NVGs
4. Navigation

2-35. What is the maximum range of the IR source for the AN/PVS-11?

1. 15 meters
2. 25 meters
3. 35 meters
4. 45 meters

QUESTIONS 2-36 THROUGH 2-47 PERTAIN TO FLAG USAGE.

2-36. On board ships, flags should NOT be used for which of the following purposes?

1. To identify the nationalities
2. To send messages and signals
3. To indicate the seniority of an officer or civil official
4. To make unofficial communication

2-37. When you are considering the cost of flags and pennants, the lowest priced bunting is made of what material?

1. Wool
2. Cotton
3. Nylon
4. Acrylic

2-38. The flags and pennants that are constantly used aboard ship are usually made of what material?

1. Wool and nylon
2. Cotton and nylon
3. Wool and cotton
4. Cotton and acrylic

2-39. What material is used in the making of a complicated design of a flag?

1. Rayon
2. Cotton
3. Nylon
4. Wool

2-40. What part of a flag is the horizontal length?

1. The fly
2. The hoist
3. The tabling
4. The snap hook

2-41. The reinforced border of light duck material, stitched to the edge of the flag at the hoist, is what part of the flag?

1. The fly
2. The hoist
3. The tabling
4. The snap hook

2-42. What part of the flag extends several inches below the tabling?

1. The fly
2. The hoist
3. The tail line
4. The snap hook

2-43. What weather condition causes rapid deterioration of flags?

1. Dry and calm
2. Dry and windy
3. Moist and calm
4. Moist and windy

2-44. Which of the following solutions should be used to launder soiled flags?

1. Mild soap and warm water
2. Mild soap and cold water
3. Mild soap and hot water
4. Warm water only

- 2-45. What procedure should you use to dry wet flags?
1. Hoist the flags on signal halyards
 2. Hang the flags over the signal bridge life rails
 3. Hang the flags from the dress ship lines
 4. Dry them in the ship's laundry
- 2-46. What type of bunting material should you use to repair a cotton flag?
1. Wool
 2. Nylon
 3. Cotton
 4. Acrylic
- 2-47. What publication should you use to find the correct dimensions for flags and pennants?
1. ACP 129
 2. ATP 1, Vol. II
 3. NTP 4
 4. NTP 13
- 2-48. Why has nylon line replaced cotton line for signal halyards?
1. Nylon line costs less
 2. Stack temperature and gases cause rapid deterioration of cotton
 3. Cotton line is hard to get
 4. Cotton line shrinks greatly when wet
- 2-49. How are halyard blocks attached to yardarms?
1. Clamped to a U-bolt
 2. Sister hooked to a U-bolt
 3. Turn buckled to a U-bolt
 4. Spliced to a U-bolt
- 2-50. What is the correct procedure for reeving halyards through a signal halyard block?
1. Aft to forward
 2. Forward to aft
 3. Inboard to outboard
 4. Outboard to inboard
- 2-51. How are rings and snaps attached to halyards?
1. By using a square knot
 2. By using a bucket bend
 3. By using a halyard short splice
 4. By using a halyard eye splice
- 2-52. How should signal halyards be secured?
1. Eased off if the weather is fair; taut if the weather is wet
 2. Taut if the weather is fair; eased off if the weather is wet
 3. Eased off no matter the weather condition
 4. Taut no matter the weather condition
- 2-53. When you splice double-braided line, where should the end of the line be worked into?
1. The center of the line
 2. Near the end of the line
 3. Near the beginning of the line
 4. It is not worked into the line
- 2-54. What special tool is used for splicing if the line circumference is larger than 3 inches?
1. Fid and pusher
 2. Wire fid
 3. Wooden fid
 4. Marlin spike
- 2-55. What percent of an average new line strength will be retained when you splice an eye splice into new double-braided line?
1. 60%
 2. 70%
 3. 80%
 4. 90%
- 2-56. The wire fid for splicing double-braided line is two times as long as the tubular fid.
1. True
 2. False

IN ANSWERING QUESTIONS 2-57 THROUGH 2-59, REFER TO FIGURES 2-23 AND 2-24 IN YOUR TEXT.

- 2-57. How many consecutive pairs of cover strands are counted off between point R and T?
1. Five
 2. Six
 3. Seven
 4. Eight
- 2-58. When you tuck the cover tail into the core, the cover tail should be pulled through the core until mark R reaches what point?
1. Mark 1
 2. Mark 2
 3. Mark 3
 4. Point T
- 2-59. What procedure should be followed if bunching occurs at the crossover?
1. Milk the cover towards the eye after untying the slipknot
 2. Milk the cover towards point X
 3. Pull the tail of the core
 4. Widen the opening in the crossover
- 2-60. What is the advantage of stitch-locking the splice prior to whipping?
1. It prevents no-load opening
 2. It prevents further shrinkage
 3. It prevents line breakage
 4. It prevents line tension
- 2-61. What should be the size of the lock-stitch twine if you are stitching a 1-inch rope?
1. Larger than the individual strands
 2. Smaller than the individual strands
 3. Same size as the individual strands
 4. Does not matter
- 2-62. What are the number of tucks needed to complete an ordinary eye splice?
1. Original round, plus three
 2. Original round, plus four
 3. Original round, plus five
 4. Original round, plus six
- 2-63. When you are eye splicing larger lines, at what time should you whip the ends of the strands?
1. After the original round
 2. In the middle of splicing
 3. Before starting the splice
 4. After completing the splice
- 2-64. What strand should always be tucked first when you make an eye splice?
1. Left
 2. Right
 3. Middle
 4. End
- 2-65. What individual should you get permission from before going aloft in-port?
1. The CO
 2. The XO
 3. The OOD
 4. The POOW
- 2-66. What manual contains general precautions and instructions for going aloft?
1. OPNAVINST 5100.19
 2. OPNAVINST 5510.1
 3. OPNAVINST 3120.32
 4. OPNAVINST 4790.4
- 2-67. What is the purpose of the 3-M systems?
1. To eliminate all equipment failures
 2. To update information on maintenance requirement cards
 3. To increase the operational readiness of fleet units
 4. To provide guidelines for each ship to implement its own maintenance procedures
- 2-68. What manual is the basic source of information on the 3-M systems?
1. OPNAVINST 3120.32
 2. OPNAVINST 4790.4
 3. OPNAVINST 5100.1
 4. OPNAVINST 5110.1

2-69. The *Hazardous Material Users Guide* was written to avoid the need for which of the following?

1. Technical jargon
2. Chemical symbols
3. Coded information
4. All of the above

2-70. The *Hazardous Materials Users Guide* covers how many hazardous material groups?

1. 10
2. 20
3. 30
4. 40

IN ANSWERING QUESTIONS 2-71 THROUGH 2-74, SELECT FROM COLUMN B THE SECTION OF THE *HAZARDOUS MATERIALS USERS GUIDE* THAT CONTAINS THE INFORMATION IN COLUMN A.

	<u>A. ELEMENT</u>	<u>B. COMPONENT</u>
2-71.	Overexposure	1. Control measures
2-72.	Storage	2. Safety precautions
2-73.	Protective equipment	3. Health hazards
2-74.	Usage of HAZMAT	4. Disposal guidelines

2-75. Which of the following is NOT a content of a MSDS?

1. Material composition
2. Chemical characteristics
3. Purchasing information
4. Safety precautions

ASSIGNMENT 3

Textbook Assignment: "Messages," chapter 3, pages 3-1 through 3-10.

- 3-1. What term denotes the command by whose authority a message is sent?
1. The drafter
 2. The releasing officer
 3. The originator
 4. The OOD
- 3-2. Who composes a message for release by the originator?
1. The drafter
 2. The releasing officer
 3. The CDO
 4. The OOD
- 3-3. Who authorizes the transmission of a message for, and in the name of, the originator?
1. The drafter
 2. The releasing officer
 3. The CDO
 4. The OOD
- 3-4. What type of message is destined for only one addressee?
1. A single-address message
 2. A multiple-address message
 3. A book message
 4. A general message
- 3-5. When the originator believes it is necessary for the addressees to know the other addressees, what type of message is sent?
1. A single-address message
 2. A multiple-address message
 3. A book message
 4. A general message
- 3-6. When the originator believes it is unnecessary for the addressees to know the other addressees, what type of message is sent?
1. A single-address message
 2. A multiple-address message
 3. A book message
 4. A general message
- 3-7. What type of message has a wide, standard distribution?
1. A single-address message
 2. A multiple-address message
 3. A book message
 4. A general message
- 3-8. All messages of a given general message title are numbered in what way?
1. By date-time group
 2. Serially
 3. Consecutively
 4. Letter-number combinations
- 3-9. What type of address is used when the originator desires to exclude an addressee?
1. Action address
 2. Exempt address
 3. Information address
 4. Single address
- 3-10. What phrase does the word *prosign* indicate?
1. Procedure signal
 2. Procedure signature
 3. Procedure significance
 4. Procedure sign

3-11. What does an overscore over a prosign indicate?

1. The prosign is to be sent as separate characters
2. The prosign is to be sent as a single character
3. The prosign should not be sent until verified by the watch supervisor
4. The prosign can only be used in directional flashing light

3-12. The procedures for the use of prosigns are contained in what publication?

1. ACP 129
2. ATP 1, Vol. II
3. ATP 2, Vol. II
4. NTP 4

IN ANSWERING QUESTIONS 3-13 THROUGH 3-16, REFER TO FIGURE 3-1 IN THE TEXT. SELECT FROM COLUMN B THE MEANING OF THE PROSIGN LISTED IN COLUMN A.

<u>A. PROSIGN</u>	<u>B. MEANING</u>
3-13. AA	1. ALL AFTER
3-14. F	2. FROM
3-15. DE	3. GROUP COUNT
3-16. GR	4. DO NOT ANSWER

IN ANSWERING QUESTIONS 3-17 AND 3-18, REFER TO FIGURE 3-2 IN YOUR TEXT.

3-17. A total of how many prosigns are contained in the heading?

1. Seven
2. Eight
3. Nine
4. Ten

3-18. How many prosigns are shown after the text?

1. Five
2. Two
3. Three
4. Four

3-19. Disregarding flaghoist signals, what are the three parts of a naval message?

1. Preamble, address, and text
2. Precedence, text, and ending
3. Address, text, and ending
4. Heading, text, and ending

3-20. What lines are the nonchangeable elements of the basic message format?

1. 1 through 3
2. 5 through 13
3. 14 through 16
4. 16 through 18

3-21. All format lines must appear in every message sent by a command.

1. True
2. False

3-22. What is the most complex part of a naval message?

1. The heading
2. The text
3. The ending
4. The ending procedure

3-23. In what three forms may a message be prepared for transmission?

1. Plaindress, codress, address
2. Codress, full address, abbreviated codress
3. Plaindress, address, shortdress
4. Plaindress, abbreviated plaindress, codress

IN ANSWERING QUESTIONS 3-24 THROUGH 3-27, SELECT FROM COLUMN B THE COMPONENT IN THE NAVY MESSAGE FORMAT THAT INCLUDES THE ELEMENT IN COLUMN A.

<u>A. ELEMENT</u>	<u>B. COMPONENT</u>
3-24. Originator	1. Procedure
3-25. Message instructions	2. Preamble
3-26. Group count	3. Address
3-27. Call	4. Prefix
<hr/>	
3-28. How many components are included in the heading of a naval message?	
	<ol style="list-style-type: none"> 1. One 2. Two 3. Three 4. Four
3-29. What two elements must be used in the procedure component in visual communication?	
	<ol style="list-style-type: none"> 1. The call and transmission instructions 2. The call and handling instructions 3. The call and transmission identification 4. The handling and transmission instructions
3-30. Which of the following groups of prosigns may be included as part of the transmission instructions?	
	<ol style="list-style-type: none"> 1. F, XMT, DE, GR 2. T, G, F, L 3. T, G, F, DE 4. T, F, L, DE

NACK DE NRDL-L-P-101930Z OCT 96-FM NOPS
 -TO NACK-INFO NABC NOPE GR7
 BT UNCLAS BE PREPARED COMMENCE
 FUELING FIRST LIGHT BT

Figure 3A.—Visual admin message.

IN ANSWERING QUESTIONS 3-31 AND 3-32, REFER TO FIGURE 3A.

- 3-31. What does the entire call element consist of?
1. NACK DE NRDL
 2. NACK DE NRDL-L
 3. NACK DE NRDL-P
 4. NACK DE NRDL-L-P
- 3-32. What is the call sign of the station being called?
1. NACK
 2. NRDL
 3. NOPS
 4. NABC
- 3-33. You visually send the following signal: NADG DE NRWL-T-P 102210Z OCT 96-FM NHCS-TO NADG-INFO NCFC NYES GR9 BT. What transmission instructions have you given NADG?
1. Repeat the message back
 2. Transmit the text only to all addressees in the address component
 3. Transmit the message to addressees in the address component
 4. Do not answer
- 3-34. What prosign should you include in the heading of a message the commanding officer wants repeated back?
1. F
 2. G
 3. L
 4. T

3-35. What prosign should be used when it is required that the station called report back when a message has been relayed?

1. F
2. G
3. L
4. T

3-36. Which of the following information is NOT contained in the preamble of a naval message?

1. Operating signals
2. Precedence
3. Date-time group
4. Originator's sign

3-37. Of the following sets of information, which one is in the proper sequence, as it would appear in a transmission?

1. Precedence, DTG, operating signal ZUI
2. Precedence, operating signal ZUI, DTG
3. DTG, precedence, operating signal ZUI
4. Operating signal ZUI, precedence, DTG

3-38. What is the purpose of a precedence assigned to a message?

1. To state the relevance of the message contents
2. To state the necessary speed of delivery
3. To state the need for a reply
4. To state the need to relay the message

3-39. What is the time requirement for the delivery of an immediate message?

1. 10 minutes
2. 20 minutes
3. 30 minutes
4. 40 minutes

3-40. What is the time requirement for the delivery of a flash message?

1. As fast as humanly possible, with an objective of less than 10 minutes
2. 15 minutes
3. 20 minutes
4. 25 minutes

3-41. What is the single letter indicator for an immediate message?

1. I
2. O
3. P
4. X

NABC DE NKZO-P-R 080950Z OCT 96-FM
NKZO-TO NABC NRST-INFO NJFK NGGO GR10

Figure 3B.—Message information.

IN ANSWERING QUESTIONS 3-42 THROUGH 3-44, REFER TO FIGURE 3B.

3-42. The originator considers the message to be of relatively greater importance to what stations?

1. NJFK and NGGO
2. NKZO and NJFK
3. NGGO and NKZO
4. NABC and NRST

3-43. The originator considers the message to be of less relative importance to what stations?

1. NKZO and NABC
2. NJFK and NGGO
3. NABC and NRST
4. NKZO and NRST

3-44. When was the message ready for transmission?

1. 0950 Greenwich mean time on 8 Oct 96
2. 0950 local time on 8 Oct 96
3. 0809 Greenwich mean time on 5 Oct 96
4. 0809 local time on 5 Oct 96

3-45. What person usually assigns the DTG of an outgoing visual message?

1. The originator
2. The drafter
3. The communications watch officer
4. The transmitting Signalman

- 3-46. Why should you inform the communications center if you assign a DTG to a message?
1. Each command's DTG is different
 2. A DTG is a positive means of identification
 3. To keep them informed of the number of messages you receive
 4. To make sure you do not receive too many messages
- 3-47. You can include a maximum of how many prosigns in the address component of a visual message?
1. One
 2. Two
 3. Three
 4. Four
- 3-48. Of the following elements, which one should immediately follow the preamble?
1. The DTG
 2. The group count
 3. The originator's sign
 4. The originator's call sign
- 3-49. What prosign is used to identify the action addressee of a visual message?
1. FM
 2. TO
 3. INFO
 4. XMT
- 3-50. What prosign is used to identify the exempt addressee of a visual message?
1. FM
 2. TO
 3. INFO
 4. XMT
- 3-51. Under what condition may you omit the address component of a visual message?
1. When all addressees are included in the call
 2. When the information addressees immediately follow the transmission instructions
 3. When the information addressees are absent from the formation
 4. When the information addressees are with the formation
- 3-52. What prosign is contained in the prefix of a naval message?
1. AA
 2. GR
 3. WA
 4. WB
- 3-53. Instructions for the use of accounting symbols are found in what publication?
1. JANAP 128
 2. JANAP 130
 3. JANAP 185
 4. JANAP 199
- 3-54. What part(s) of a message should you count to determine the group count of the message?
1. The heading only
 2. The ending only
 3. The text only
 4. The heading, the ending, and the text
- 3-55. When sending an encrypted message, you should place the group count in what part(s)?
1. The heading only
 2. The ending only
 3. The text
 4. The heading and the ending
- 3-56. In what type of message may you omit the group count element?
1. Codress message
 2. Plain language message
 3. Encrypted message
 4. Abbreviated service message

- 3-57. Punctuations are not counted as groups unless they are abbreviated or spelled out.
1. True
 2. False
- 3-58. Indicate the correct group count of the following message: NKZO DE NJFK-L-R-100827Z OCT 96 BT UNCLAS WILL ARRIVE AT POINT OSCAR AT 101010Z OCT 96. REQUEST HIGH-LINE TRANSFER OF GOODS UPON COMMENCING AT NOON. BT.
1. 12
 2. 15
 3. 18
 4. 19
- 3-59. What prosign immediately precedes and follows the text?
1. BT
 2. IMI
 3. GR
 4. TO
- 3-60. What is the textual format of a naval message designed to accomplish?
1. Readability and conciseness
 2. Shortness and cogency
 3. Succinctness and summarization
 4. Terseness and authority
- 3-61. What is the highest classification authorized for transmission of a visual message?
1. Unclassified
 2. Confidential
 3. Secret
 4. Top Secret

IN ANSWERING QUESTIONS 3-62 THROUGH 3-64, REFER TO THE FOLLOWING INFORMATION: THE COMMANDING OFFICER RELEASES A MESSAGE CONTAINING THE ELEMENTS IN COLUMN A. SELECT FROM COLUMN B THE ORDER IN WHICH YOU WILL TRANSMIT THESE ELEMENTS.

	<u>A. ELEMENTS</u>	<u>B. ORDER</u>
3-62.	Subject	1. 1
3-63.	Text	2. 2
3-64.	Classification	3. 3

- 3-65. The elements of a message include (A) reference, (B) special project nickname, (C) flag word, (D) special category marking, and (E) an exercise identification. In what order should you place these elements before sending the message?
1. D, E, A, B, C
 2. D, E, B, C, A
 3. A, B, C, E, D
 4. B, C, A, E, D
- 3-66. When you are transmitting by flashing light, should you identify the paragraph of a single-paragraph message? If so, how?
1. Yes; by number
 2. Yes; by letter
 3. Yes; by transmitting PARA
 4. No
- 3-67. What individual aboard ship is authorized to send a Confidential message by visual means?
1. The commanding officer
 2. The executive officer
 3. The communication officer
 4. The signal officer

- 3-68. What elements should you normally include in the ending of each plaindress message you transmit?
1. Prosign BT and a time group
 2. Time group and final instructions
 3. Time group and ending sign
 4. Final instructions and ending sign
- 3-69. While transmitting the second long-break prosign, you realize that you have signaled 2 rather than ~~Z~~ as the date-time group in the suffix. After sending the long-break prosign, what procedure should you follow to correct the mistake?
1. C 101515~~Z~~
 2. C 2 to read ~~Z~~
 3. C WA OILER 101515~~Z~~
 4. C WA OILER IS 101515~~Z~~
- 3-70. What prosign is NOT preceded by C when instructing a receiving station to correct portions of the text?
1. AA
 2. AB
 3. WB
 4. GR
- 3-71. You have two routine messages to send to the same ship. As a part of the final instructions of the first message, what signal should you send to indicate to the receiving station you have another message for them?
1. B
 2. BR
 3. B Routine
 4. MORE TO FOLLOW
- 3-72. If you request the receiving station to repeat back a message you transmit to them, what prosign should you use in the final instructions?
1. K
 2. L
 3. G
 4. C
- 3-73. What prosign means THIS IS THE END OF MY TRANSMISSION TO YOU, AND NO RESPONSE IS REQUIRED OR EXPECTED?
1. AS
 2. AR
 3. AS AR
 4. AR AS
- 3-74. What abbreviation identifies a plain-language service message?
1. SER
 2. SVC
 3. MSG
 4. A-SER
- 3-75. In what part of a message should you insert information that designates it as a service message?
1. The procedure component of the heading
 2. The preamble component
 3. The text
 4. The ending

ASSIGNMENT 4

Textbook Assignment: "Messages" (continued) and "Allied Communications Procedures," chapters 3 and 4, pages 3-10 through 4-2.

- 4-1. What should be the precedence sign of a service message if the message to which it refers has a priority precedence?
1. Routine
 2. Priority
 3. Immediate
 4. Flash
- 4-2. What components of an abbreviated plaindress message may be partially or completely eliminated?
1. The heading and ending
 2. The address and preamble
 3. The prefix and ending
 4. The preamble and prefix
- 4-3. What type of information is contained in the heading of a codress message?
1. Information to enable personnel to handle it properly
 2. Information concerning disposal of the message
 3. Information describing the contents of the text
 4. Information describing the contents of the ending procedure
- 4-4. What is the definition of a combination of characters or pronounceable words designed for use in message headings to identify a command, authority, unit, or communication facility?
1. Call sign
 2. Station and address designator
 3. Address indicating group
 4. Special operating group
- 4-5. What is the definition of letters, letter-number combinations, or one or more pronounceable words used for establishing communication?
1. Special operating groups
 2. Address indicating groups
 3. Call signs
 4. Plain language stations and address designators
- 4-6. What is the main use of visual call signs?
1. To amplify the meaning of a signal
 2. To expedite communication
 3. To reduce message transmission time
 4. To establish and maintain communication
- 4-7. Personnel from what service are probably operating a station with the call sign WRAW?
1. Navy
 2. Merchant Marine
 3. Marine Corps
 4. Coast Guard
- 4-8. What international call sign block is reserved for use by the Coast Guard?
1. A
 2. C
 3. N
 4. W
- 4-9. What international call sign block is reserved for use by the Marine Corps?
1. A
 2. M
 3. N
 4. W

IN ANSWERING QUESTIONS 4-10 THROUGH 4-14, SELECT FROM COLUMN B THE INTERNATIONAL CALL SIGN THAT MAY BE ASSIGNED TO THE STATION IN COLUMN A.

<u>A. STATION</u>	<u>B. CALL SIGN</u>
4-10. Army	1. ABNO
4-11. Air Force	2. KCOL
4-12. Marine Corps	3. NALL
4-13. Coast Guard	4. KDOR

4-15. What international call sign should be used by a Marine Corps aircraft?

1. N1235
2. NM1234
3. NKZO
4. NBNI

4-16. What international call sign should be used by a Navy aircraft?

1. KROR
2. N2223
3. NABC
4. NBN1

4-17. What international call sign should be used by a naval shore communication station?

1. NAM1
2. NABC
3. N1234
4. NM1234

4-18. The international call sign for a Coast Guard aircraft consists of which of the following items?

1. The plane's entire serial number
2. The last four digits of the plane's serial number
3. The letters CG plus the last four numbers of the plane's serial number
4. The letters NC plus the last four numbers of the plane's serial number

4-19. What call signs represent no specific facility, command, authority, or unit?

1. Net
2. Indefinite
3. Voice
4. Visual

4-20. What call sign is highly significant in determining the length of a flaghoist and reducing the transmission times of messages by other visual means?

1. Indefinite
2. Net
3. Voice
4. Visual

4-21. To complete, amplify, or vary the meaning of a signal, where should you place the visual call?

1. Preceding the signal
2. Following the signal
3. In conjunction with the signal
4. After the preamble

4-22. What prosign is used when call signs are placed in the text of signals?

1. \overline{PT}
2. \overline{OL}
3. \overline{IX}
4. AR

4-23. When call signs are spelled out in the text of a message, they need not be preceded by the prosign \overline{PT} .

1. True
2. False

IN ANSWERING QUESTIONS 4-24 THROUGH 4-28, SELECT THE TYPE OF INDICATOR FROM COLUMN B THAT DESCRIBES THE SHIP IN COLUMN A.

<u>A. SHIP</u>	<u>B. INDICATOR</u>
4-24. Cargo ship	1. A
4-25. Tank landing ship	2. P
4-26. Minelayer	3. L
4-27. Patrol escort	4. N
4-28. Fast motor craft	

4-29. A single-letter indicator is NOT provided for which of the following units?

1. Aircraft
2. Boats
3. Yard craft
4. Coast Guard ships

4-30. When two ships in formation have the same visual call, what call sign should each ship use?

1. Its military call sign
2. Its international call sign
3. Its special call sign
4. Its voice call sign

4-31. You are aboard a cruiser in port and have a message for DD 566. Another destroyer present has hull number 676. What visual call sign should you use to contact DD 566?

1. Dp6
2. Dp5p6
3. Dp6p6
4. Dp5p6p6

4-32. What visual call sign should you hoist to contact carrier squadron 8?

1. SQUAD Rp8
2. SQUAD 8R
3. Rp8 SQUAD
4. R SQUAD p8

4-33. What visual call sign should you hoist for minesweeper squadron 16?

1. SQUAD Np1p6
2. M SQUAD p1p6
3. SQUAD Mp6
4. Mp6 SQUAD

4-34. All ships of destroyer group 4 are present in port. You are aboard the flag ship and have a message for all ships and unit commanders in the group. What visual call sign should you use?

1. GROUP/FLOT p4
2. GROUP/FLOT Dp4
3. Dp4 GROUP/FLOT
4. D GROUP/FLOT p4

4-35. What visual call sign should you hoist to call the commander of this destroyer squadron?

1. D SQUAD
2. SQUAD D
3. SQUAD
4. D

4-36. What call sign should you hoist to call only the screen commander of the group?

1. pØp5
2. pØpØp5
3. pØp5pØp5
4. Øp5

4-37. What activity does the call sign p7C indicate?

1. Cruisers of task group 7
2. Cruisers of this task group
3. Number of cruisers in this task group
4. Commander of this task group

4-38. What visual call sign should you hoist to call all destroyers?

1. Dp2
2. p2D
3. Dp2D
4. D2p

- 4-39. What type of call signs are used in flaghoist communication only?
1. Special task organization call signs
 2. Convoy visual call signs
 3. Numeral pennant call signs
 4. Unit indicator call signs
- 4-40. Your commanding officer wishes to signal the commander of task unit 3 within the task organization. What call sign should you hoist?
1. 0p3
 2. 2p3
 3. 3p3
 4. 4p3
- 4-41. The flagship hoists a signal preceded by the call sign 7p2L. What units are being addressed?
1. Assault vessels of task unit 2
 2. Assault vessels of task group 2
 3. Assault vessels of task element 2
 4. Assault vessels of task force 2
- 4-42. What call sign should you use for COMSIXTHFLT when transmitting an intra-USN message by flashing light?
1. 4p6
 2. 46
 3. Four p6
 4. Four six
- 4-43. What letter should you use to call a shore signal station?
1. G
 2. H
 3. K
 4. Q

IN ANSWERING QUESTIONS 4-44 THROUGH 4-47, SELECT FROM COLUMN B THE VISUAL CALL SIGN HAVING THE MEANING SHOWN IN COLUMN A.

<u>A. MEANINGS</u>	<u>B. CALL SIGN</u>
4-44. Commander naval base	1. Hp4
4-45. Port director	2. Hp0
4-46. Commander in chief	3. Hp3
4-47. SOPA (ashore)	4. Hp8

-
- 4-48. While at anchor, the OOD orders you to hoist the recall signal for the captain's gig. What signal should you hoist?
1. Qp1
 2. Qp2
 3. Qp3
 4. Qp4
- 4-49. What signal should you hoist to call all boats?
1. p2B
 2. p2
 3. Qp0
 4. Qp0B
- 4-50. You have the signal watch aboard CV 70. You are ordered to call alongside the captain's gig of DD 968. What signal should you hoist?
1. Qp4Rp7p0
 2. Qp4Dp8
 3. Qp4Dp6p8
 4. Qp4Dp9p6p8
- 4-51. An address group, regardless of its type, consists of how many letters?
1. Five
 2. Two
 3. Three
 4. Four

- 4-52. What is the distinction between an address group and a Navy-assigned international call sign (ICS)?
1. An address group starts with the letter N; a Navy-assigned ICS does not
 2. An address group never starts with the letter N; a Navy-assigned ICS always does
 3. An address group always has three letters; a Navy-assigned ICS always has four letters
 4. An address group always has letter or number combinations; a Navy-assigned ICS never has letter or number combinations
- 4-53. Which of the following naval units will NOT be assigned an address group?
1. System command
 2. Type commander
 3. NODAC
 4. Individual ship
- 4-54. What address group represents a single command or unit, either afloat or ashore?
1. Collective
 2. Conjunctive
 3. Geographical
 4. Individual activity
- 4-55. What address group represents two or more commands, authorities, activities, units, or a combination of these?
1. Collective
 2. Conjunctive
 3. Geographical
 4. Individual activity
- 4-56. What type of address group must always be preceded by another type of address group to complete its meaning?
1. Geographic
 2. Collective
 3. Individual activity
 4. Conjunctive
- 4-57. What address group should be used only when it is necessary to complete the titles of addressees or originators?
1. Conjunctive
 2. Geographical
 3. Individual activity
 4. Address indicating
- 4-58. What address groups should NOT be used with the name of naval or merchant ships or the titles of commands afloat?
1. Address indicating
 2. Collective
 3. Conjunctive
 4. Geographical
- 4-59. What is/are the main purpose(s) of address indicating groups?
1. To increase security
 2. To increase the speed of traffic handling and to reduce the length of address components
 3. To eliminate message headings
 4. To notify addressees of incoming messages
- 4-60. Address indicating groups can be used whenever suitable, regardless of whether the message is classified or unclassified.
1. True
 2. False
- 4-61. What groups are used in the heading and give special instructions?
1. Special address groups
 2. Special operating groups
 3. Plain language stations
 4. Address indicating groups
- 4-62. Plain language address designators are NOT used in communicating with which of the following activities?
1. A civilian shore installation
 2. A U.S. Air Force activity
 3. A U.S. Army activity
 4. An allied armed forces installation

- 4-63. A high-precedence message is recorded by a Signalman and handed to you, the signal supervisor. You show the message to the OOD. In most cases, what do you do next with the message?
1. Have it delivered to CIC
 2. Show it to the communication watch officer
 3. Show it to the commanding officer
 4. Have it delivered to the communication center
- 4-64. As a Signalman supervisor, to what individual(s) should you relay incoming tactical signals?
1. CIC only
 2. OOD only
 3. CIC and OOD
 4. CIC and communication officer
- 4-65. Of the following shipboard communication factors, which one has NO bearing on the method chosen?
1. The need for accuracy
 2. The need for security
 3. The speed of transmission
 4. The time of transmission
- 4-66. What procedure should you use to communicate with civil stations?
1. Allied procedures
 2. Special procedures
 3. International procedures
 4. Ship-to-shore procedures
- 4-67. What communication elements provide a brevity code for the passing of information pertaining to communications, aircraft operation, and search and rescue?
1. Operating signals
 2. Allied procedures
 3. Special procedures
 4. Ship-shore movements
- 4-68. What publication contains operating signals?
1. ACP 110
 2. ACP 113
 3. ACP 129
 4. ACP 131
- 4-69. You should use numbered flags when using operating signals to communicate with what type of units?
1. Allied
 2. Non-allied
 3. Special
 4. Commercial
- 4-70. What operating signals are allocated to the allied military and are held by all military stations?
1. QAA-QNZ
 2. QRA-QUZ
 3. ZAA-ZXZ
 4. ZYX-ZZZ
- 4-71. When you use non-allied procedures to reply to a question in the affirmative, which of the
1. ZOE QAR
 2. QAR ZOE
 3. C QAR
 4. QAR C

The operating signal QRS means "SEND MORE SLOWLY." A number following this signal indicates the number of words per minute.

Figure 4A.—Operating signal.

IN ANSWERING QUESTIONS 4-72 AND 4-73, REFER TO FIGURE 4A.

- 4-72. What signal should the Signalman aboard NFCH transmit to ask you to slow to six words per minute?
1. QRS
 2. QRS6
 3. QRS6 K
 4. K QRS6

4-73. You are aboard NDHY transmitting a message to NFCH. The receiving Signalman is slow receiving the message. What signal should you transmit to ask if you should send slower?

1. $\overline{\text{IMI}}$ QRS K
2. $\overline{\text{INT}}$ QRS K
3. QRS $\overline{\text{IMI}}$ MK
4. QRS $\overline{\text{INT}}$ K

4-74. In visual communications, relaying is automatic when the call is made up of what type of call signs?

1. International call signs
2. Collective call signs
3. Tactical call signs
4. Indefinite call signs

4-75. A maneuver alters the position of a ship relative to the OTC. How will the ship's responsibility for relaying messages be affected?

1. It will be reassigned by the OTC
2. It rests with the OTC
3. It falls to the next ship in line
4. It does not change until the maneuver is complete

ASSIGNMENT 5

Textbook Assignment: "Allied Communication Procedures," chapter 4, pages 4-3 through 4-13.

- 5-1. In multiple-line formations, which officer is responsible for ships in his/her own line?
1. Junior officer
 2. Senior officer
 3. Line commander
 4. Assistant line officer
- 5-2. Commander-assigned visual relaying responsibility depends in part on which of the following factors?
1. The number of ships in the formation
 2. The sizes of ships in the formation
 3. The capabilities of ships in the formation
 4. The types of ships in the formation
- 5-3. Of the following terms, which one is NOT an example of a "repeating ship"?
1. A ship designated as a repeating ship
 2. A ship that automatically relays messages
 3. A ship through which a message is routed
 4. A ship that cannot pass messages through radio central
- 5-4. If you deviate from prescribed communication procedures, you may be responsible for which of the following actions?
1. Making security precautions valueless
 2. Eliminating confusion on the part of the receiver
 3. Increasing operational speed
 4. Increasing operational reliability
- 5-5. In following prescribed communication procedures, you are permitted to make which of the following transmissions?
1. Profanity or obscene language
 2. Your personal sign
 3. Plain language when not authorized to do so
 4. Authorized prosigns
- 5-6. In visual communications procedures, what governs the speed of transmission?
1. Prevailing conditions and the capability of the receiving operator
 2. Prevailing conditions and the capability of the transmitting operator
 3. The type of message being transmitted
 4. The length of the message being transmitted
- 5-7. In visual communications procedures, what is far more important than speed?
1. Accuracy
 2. Reliability
 3. Security
 4. Receipt of the message
- 5-8. At what speed should the transmitting operator send a message?
1. At the speed good for him/her
 2. At the speed that the receiving operator can copy without having to obtain repetitions
 3. As fast as possible
 4. As slow as possible
- 5-9. When you transmit messages, you may substitute abbreviations for plain language or plain language for abbreviations.
1. True
 2. False
- 5-10. Call signs and address groups in a message heading should be arranged in what order?
1. Alphabetically
 2. In the order of transmission
 3. By seniority
 4. Randomly

- 5-11. The messenger of the watch tells you that the commanding officer wants to be sure that, of all the ships in company, only the ship addressed can read the message. By what means should you transmit the message?
1. Directional flashing light
 2. Non-directional flashing light
 3. Flaghoist
 4. Semaphore
- 5-12. The message has an immediate precedence and is addressed to several ships. If the addressees are positioned so that they can all be communicated to simultaneously, by what method should you transmit the message?
1. Semaphore
 2. Flaghoist
 3. Non-directional flashing light
 4. Directional flashing light
- 5-13. What prosign is used to inform a ship that her light is brighter than necessary?
1. B
 2. C
 3. D
 4. F
- 5-14. When communicating by flashing light, what procedure should you use when the transmitting station waits for a flash for each word or group transmitted?
1. Directional
 2. Non-directional
 3. Non-directional infrared
 4. DSL
- 5-15. What operating signal is used when you, as the repeating ship, miss a portion of a message you are relaying?
1. QRR
 2. QRU
 3. ~~Z~~EP
 4. ~~Z~~UI
- 5-16. You have received a message using non-directional procedure. After checking the message, you are ready to receipt for it. What signal should you send to receipt for the message?
1. R
 2. RR
 3. RRR
 4. RRRR
- 5-17. What method of communication is being used when the receiving station hoists DESIG?
1. Flaghoist
 2. Semaphore
 3. Daylight signaling lantern
 4. Infrared
- 5-18. You want to send a flashing light message to a ship well within visual range. Rather than use a full call, you raised the ship by means of its abbreviated call sign. What does the abbreviated call involve?
1. Abbreviating the call sign of the ship being called
 2. Abbreviating your ship's call sign
 3. Omitting the call of the ship being called
 4. Omitting your ship's call sign
- 5-19. What call sign consists of a single call sign representing more than one station?
1. Full call
 2. Multiple call
 3. Collective call
 4. Abbreviated call
- 5-20. When abbreviated calls are used, it is assumed that the message is addressed to which officer?
1. The senior officer embarked
 2. The commanding officer
 3. The officer of the deck
 4. The executive officer
- 5-21. When more than one station is being called in the same direction or during low visibility, how does the answering station indicate its identity?
1. By transmitting its call sign followed by the prosign K
 2. By transmitting the prosign DE followed by a call sign and the prosign K
 3. By transmitting the prosign K followed by its call sign
 4. By transmitting its call sign

- 5-22. You are aboard C60 and transmit a message to C35 with instructions for C35 to transmit the message to D15. What heading should you use?
1. C35 DE C60 T R 192315Z OCT 96 FM C60 TO C35 D15
 2. C35 DE C60 R 192315Z OCT 96 FM C60 TO C35 T D15
 3. C35 T D15 DE C60 R 192315Z OCT 96 FM C60 TO C35 D15
 4. C35 DE C60 C35 T D15 R 192315Z OCT 96 FM C60 TO C35 D15

5-23. What prosign is used when the relaying ship desires to report that the message has been delivered?

1. B
2. F
3. L
4. T

5-24. What type of message is used to obtain a correction once a receipt has been given for that message?

1. A service or an abbreviated service message
2. An abbreviated plaindress message
3. A codress message
4. An encrypted message

5-25. The prosign IMI cannot be used to request repetitions after a receipt has been given.

1. True
2. False

5-26. What prosign is used to obtain a verification and repetition of the entire transmission?

1. C
2. G
3. J
4. R

5-27. What signal should you send to obtain a repeat of a message heading?

1. $\overline{\text{IMI}}$ AB $\overline{\text{BT}}$
2. $\overline{\text{IMI}}$ WB $\overline{\text{BT}}$
3. $\overline{\text{IMI}}$ AA $\overline{\text{BT}}$
4. AB $\overline{\text{IMI}}$ $\overline{\text{BT}}$

5-28. What signal should you transmit to request repetition of the last message sent?

1. K $\overline{\text{IMI}}$
2. $\overline{\text{IMI}}$ K
3. $\overline{\text{IMI}}$ AA DE
4. G

5-29. What signal should you transmit to request repetition of the ninth group?

1. 9 $\overline{\text{IMI}}$ K
2. $\overline{\text{IMI}}$ K
3. $\overline{\text{IMI}}$ 9 K
4. G9K

5-30. What signal should you transmit to request repetition of the third group and the fifth to ninth groups?

1. $\overline{\text{IMI}}$ 3, 5, 9 K
2. $\overline{\text{IMI}}$ 3-9 K
3. $\overline{\text{IMI}}$ 3-5 to 9 K
4. $\overline{\text{IMI}}$ 3 to 5-9 K

5-31. What prosign is prohibited from being transmitted except as ordered by the commanding officer or a designated originating officer?

1. C
2. G
3. I
4. W

D3 DE D5-R-222225Z OCT 96-FM D5-TO D3-
INFO C7 $\overline{\text{BT}}$ UNCLAS STAY ON PRESENT
COURSE. WILL CONTACT YOU IF ANY
CHANGE IN PLAN $\overline{\text{BT}}$ K

Figure 5A.—Flashing light message.

IN ANSWERING QUESTIONS 5-32 AND 5-33, REFER TO FIGURE 5A.

5-32. What signal should D3 send to request a verification and repetition of the entire message?

1. G 222225Z OCT 96 K
2. 222225Z OCT 96 K
3. J 222225Z OCT 96 K
4. 222225Z OCT 96 K

5-33. What signal should D3 send to request verification and repetition of the heading?

1. D5 DE D3 J 222225Z OCT 96
HEADING K
2. D5 DE D3 J 222225Z OCT 96 AB BT K
3. D5 DE D3 J 222225Z OCT 96 AA BT K
4. D5 DE D3 J 222225Z OCT 96 AA DE K

5-34. The executive method of communication is used when the OTC desires that ships in company execute a signal at what time?

1. At stated intervals
2. At the same time
3. At random intervals
4. As soon as possible

5-35. What type of message should you use when communicating by the executive method?

1. Plaindress
2. Abbreviated plaindress
3. Abbreviated service
4. Codress

5-36. What prosign should you insert before the first BT when communicating by the executive method?

1. IX
2. IMI
3. EX
4. XI

5-37. What prosign should you transmit to execute a tactical signal?

1. IX IX IX
2. AR AR AR
3. EX EX EX
4. IX and a 5-second flash

IN ANSWERING QUESTIONS 5-38 THROUGH 5-40.
REFER TO THE FOLLOWING INFORMATION:
The OTC SIGNALS IX BT TURN STBD BT K.

5-38. What maneuvering information does the signal convey to your commanding officer?

1. TURN STBD has been canceled
2. TURN STBD has been executed
3. Execute TURN STBD immediately
4. Execute TURN STBD on signal

5-39. What action determines that the signal is a delayed executive message?

1. There is a single prosign IX
2. The text is sent twice
3. The receiver receipts for the message
4. The receiver does not receipt for the message

5-40. As the receiver, you read TURN as TRRN. To correct this error, you should request a repeat of what portion of the signal?

1. The entire signal
2. The word after BT
3. All before STBD
4. All after BT

5-41. You are told by the OOD to cancel TURN PORT, the only outstanding executive method message. What message should you send to accomplish this?

1. BT NEGAT BT 1515Z K
2. BT ANNUL BT 1515Z K
3. BT NEGAT TURN PORT BT K
4. BT ANNUL TURN PORT BT K

5-42. If the signal TURN PORT was one of two unexecuted executive method messages, what message should you transmit to cancel it?

1. BT NEGAT BT 1515Z K
2. BT ANNUL BT 1515Z K
3. BT NEGAT TURN PORT BT 1515Z K
4. BT ANNUL TURN PORT BT 1515Z K

5-43. What part of the transmission should you repeat when signaling by the immediate executive method?

1. The text
2. The text and call up
3. The text and execute-to-follow prosign
4. The entire transmission

5-44. What prosign is used to call an aircraft?

1. AA
2. AB
3. WA
4. WB

- 5-45. If an aircraft is unable to receipt for a flashing light message by flashing light, what action should the pilot take?
1. Open and close the throttle
 2. Give the thumbs up sign
 3. Rock the wings
 4. Use voice radio
- 5-46. In general, infrared communications using non-directional procedures are reserved for messages that have which of the following characteristics?
1. Limited distribution
 2. Wide distribution
 3. High priority
 4. High classification
- 5-47. What equipment is needed to communicate with directional infrared?
1. AN/SAT 2
 2. Yardarm blinkers
 3. Searchlight fitted with an H-hood
 4. Daylight signaling lantern
- 5-48. You are handed a signal after darkness for immediate delivery by infrared light. Before sending the signal, you should alert the receiving station by use of what code word over voice radio?
1. INFRARED LIGHT
 2. H-HOOD
 3. HIGH POCKET
 4. NANCY HANKS
- 5-49. The flagship alerts your ship by voice radio that it has an infrared communication to transmit. What lights should you switch on to assist the flagship Signalman in aiming his light?
1. Infrared receiver
 2. Infrared yardarm blinkers
 3. Point-of-train light
 4. Small signal light fitted with an infrared filter
- 5-50. What method of communications is better adapted for long messages?
1. Sound
 2. Pyrotechnics
 3. Flashing light
 4. Semaphore
- 5-51. What is the main difference between signaling by flashing light and signaling by semaphore?
1. The message parts
 2. The rules for visual responsibility
 3. The signaling procedures
 4. The use of call signs
- 5-52. You are sending a message by semaphore. What should you signal to indicate the end of each word?
1. Front sign
 2. Attention sign
 3. Separative sign
 4. Numeral sign
- 5-53. You are receiving a semaphore message. The sender precedes and follows a six-character group by the numeral sign. What should be your reaction?
1. Record the six-characters as digits
 2. Repeat each character
 3. Request verification of the six characters
 4. Inform the supervisor of the watch that part of the message is in code
- 5-54. You have a semaphore message for a nearby ship. Rather than make that ship's call sign, you should alert the ship by making what signal?
1. Front sign
 2. Attention sign
 3. Code Juliett
 4. Desig
- 5-55. What signal should you make to answer a semaphore call from another ship?
1. Answer sign
 2. Desig Juliett
 3. Attention sign
 4. K
- 5-56. To alert a ship by flashing light that you are about to transmit a semaphore message, what signal should you send?
1. SEM
 2. SEMAPHORE
 3. STANDBY SEM
 4. STANDBY SEMAPHORE

- 5-57. What special semaphore move sign means MOVE TO YOUR LEFT, AS YOU FACE ME?
1. SL
 2. ML
 3. SML
 4. MSL
- 5-58. When making a call for a semaphore message by flashing light, how should you answer that call?
1. By semaphore only
 2. By flashing light only
 3. By semaphore or flashing light
 4. By flaghoist
- 5-59. To alert a ship by flaghoist that you are about to transmit an immediate precedence semaphore message, you must hoist (A) DESIG, (B) addressee call sign, (C) JULIETT, and (D) OSCAR. In what order should you hoist the signal?
1. B, A, D, C
 2. D, A, B, C
 3. C, B, D, A
 4. B, C, A, D
- 5-60. You can acknowledge receipt of a semaphore message by sending the prosign R by semaphore or by
1. hauling down ANSWER
 2. hauling down JULIETT
 3. dipping ANSWER
 4. dipping JULIETT
- 5-61. If the transmitting station has more semaphore messages to send and it is using a flaghoist call, what is done to the call at the end of each completed message?
1. It is hauled down
 2. It is closed up
 3. It is dipped
 4. It is replaced by the appropriate prosign
- 5-62. The procedure for requesting a repetition in semaphore is basically the same as that of flashing light.
1. True
 2. False
- 5-63. When using the flaghoist method of calling, how should you indicate to a sending station that you can NOT receive its semaphore signal?
1. Hoist JULIETT
 2. Dip JULIETT
 3. Hoist ANSWER
 4. Dip ANSWER
- 5-64. The use of the executive method is authorized for use with semaphore.
1. True
 2. False
- 5-65. What publication contains guidelines that you should use to identify pyrotechnic lights, flares, and rockets for international emergency situations?
1. ACP 129
 2. ACP 150
 3. ACP 168
 4. Pub 102
- 5-66. What determines the meaning of a pyrotechnic signal?
1. Altitude
 2. Trajectory
 3. Color
 4. Duration of visibility
- 5-67. Which of the following are the only satisfactory pyrotechnic colors?
1. Red, white (yellow), green
 2. Red, white, blue
 3. Blue, black, purple
 4. Blue, orange, black
- 5-68. By which of the following means may the authenticity of a pyrotechnic signal be determined?
1. The signal is internationally recognized
 2. The signal is repeated at least once
 3. The source of origin can be identified
 4. The weather is clear
- 5-69. Once a pyrotechnic signal has been fired, there is no method of canceling it.
1. True
 2. False

- 5-70. The range of visibility for a pyrotechnic depends largely on what condition?
1. The type of pyrotechnic flare used
 2. The type of pyrotechnic pistol
 3. The angle in which you fired the flare
 4. The weather
- 5-71. In which of the following ways do sound messages differ from flashing light messages?
1. Sound messages have no heading or ending
 2. Sound messages are not sent to individual ships
 3. Sound messages require no receipt
 4. Sound messages always require relaying
- 5-72. The OTC transmits a sound signal to find out what ships are within hearing distance. What sound signal should you transmit back to indicate that you are in the area?
1. Your name
 2. Your visual call sign
 3. Your collective call
 4. Your three-letter voice radio call sign
- 5-73. To receipt for a sound signal from D3, the OTC should transmit what signal?
1. Text DE D3
 2. D3 K
 3. D3 R
 4. R D3
- 5-74. What signal should the OTC send to direct another ship to receipt for a sound signal?
1. D3 K
 2. D3 R
 3. D3 K R
 4. D3 R K

ASSIGNMENT 6

Textbook Assignment: "Allied Communication Procedures" (continued) and "Allied Flaghoist Procedures," chapters 4 and 5, pages 4-13 through 5-6.

-
- 6-1. When the OTC orders a course change by sound, what should the executive signal include?
1. The repeated text
 2. A 5-second blast
 3. A 5-second blast followed by the text
 4. The prosign \overline{IX}
- 6-2. Basic guidance for voice communications is contained in what publication?
1. ACP 121
 2. ACP 125
 3. ACP 129
 4. ACP 131
- 6-3. When using voice radio, you should bear in mind that poor circuit discipline on your part may result in enemy interception.
1. True
 2. False
- 6-4. Unofficial conversation between operators is authorized on a radiotelephone circuit.
1. True
 2. False
- 6-5. Within a radio net, what station is usually net control?
1. The junior station
 2. The senior station
 3. The shore station
 4. The afloat station
- 6-6. In a free net, what station authorizes stations to transmit traffic to other stations without first obtaining permission?
1. The direct net station
 2. The secure net station
 3. The net control station
 4. The open net station
- 6-7. When two or more stations have traffic to send, in what order does the net control station grant permission?
1. By station seniority
 2. By DTG
 3. By serial number
 4. By message precedence
- 6-8. Administrative circuits are free nets and direct nets associated with in-port communications.
1. True
 2. False
- 6-9. What log is maintained, when possible, on all radiotelephone nets or circuits?
1. Radio log
 2. Circuit log
 3. Net log
 4. Administrative log
- 6-10. The originator, time of receipt, and date-time group are entered in the circuit log to identify a message.
1. True
 2. False
- 6-11. When you are correcting an entry in the circuit log, which of the following procedures should you use?
1. Erase the entry and reenter it
 2. Cross out the page and start a new page
 3. Draw a single line through the original entry, then enter the change adjacent to the lined-out entry
 4. Draw several lines through the original entry, initial, then make the new entry on the preceding page
- 6-12. What circuit log term indicates that a complete log is optional, but all traffic of interest to ownship must be logged?
1. Guard
 2. Cover
 3. Listen
 4. Copy
- 6-13. Although logs may be kept manually, automatic recording devices should be used whenever possible on circuits requiring complete logs.
1. True
 2. False

6-14. To distinguish numerals from words similarly pronounced, what proword should you use before such numerals?

1. NUMBER
2. NUMBER TO FOLLOW
3. FIGURES
4. FIGURES TO FOLLOW

6-15. In the executive method of communicating, the flashing light signal of execution is \overline{IX} followed by a 5-second dash. What radiotelephone proword is the equivalent to that signal?

1. EXECUTE
2. EXECUTE NOW
3. IMMEDIATE EXECUTE
4. STANDBY EXECUTE

6-16. What proword should always end a DO NOT ANSWER transmission?

1. EXECUTE
2. OVER
3. OUT
4. DO NOT ANSWER

6-17. What proword has the same meaning as the prosign K?

1. SEND YOUR
2. OUT
3. WAIT
4. WILCO

6-18. The proword RELAY, sent by voice radio, is equivalent to what prosign?

1. J
2. L
3. R
4. T

6-19. What operating signal should you use when no reply is received from a station called?

1. ZEV
2. ZGN
3. ZOK
4. ZUG ZKB

6-20. What proword has the same meaning as the prosign R?

1. I RECEIPT
2. RECEIPT
3. I ROGER
4. ROGER

6-21. The proword MESSAGE normally is used on non-administrative nets for what reason?

1. To indicate an immediate message follows
2. To indicate from NCS that it has a message for all stations
3. To determine if stations are monitoring circuits
4. To indicate that a message requiring recording is about to follow

6-22. Which of the following types of signals are preceded by the proword SIGNALS?

1. Tactical signals sent on a commercial net only
2. Tactical signals sent on a tactical net only
3. Tactical signals sent on a non-tactical net only
4. All tactical signals

IN ANSWERING QUESTIONS 6-23 THROUGH 6-26, SELECT FROM COLUMN B THE PROWORD THAT IS EQUIVALENT TO THE PROSIGN IN COLUMN A.

	<u>A. PROSIGN</u>	<u>B. PROWORD</u>
6-23.	\overline{IX}	1. WAIT-OUT
6-24.	$\overline{AS} \overline{AR}$	2. SAY AGAIN
6-25.	\overline{AA}	3. ALL AFTER
6-26.	\overline{IMI}	4. EXECUTE TO FOLLOW

6-27. How should the number 16,000 be spoken in radiotelephone procedures?

1. SIX-TEEN TOU-ZAND
2. SIX-TEEN ZE-RO ZE-RO ZE-RO
3. WUN SIX ZE-RO ZE-RO ZE-RO
4. WUN SIX TOU-ZAND

6-28. How should you report the range of an aircraft at a distance of 125 miles?

1. WUN TOO FIFE
2. WUN HUN-DRED TOO FIFE
3. WUN TWEN-TY FIFE
4. WUN HUN-DRED TWEN-TY FIFE

- 6-29. You spot a ship hull down at 290°. How should you report this bearing?
1. TOO HUN-DRED NINE-TY
 2. TOO NIN-ER ZE-RO
 3. TOO NINE-TY
 4. TOO NIN-ER OH
- 6-30. When communicating by voice radio, how should you transmit your message?
1. Sentence by sentence
 2. Word by word
 3. Phrase by phrase
 4. Text by text
- 6-31. Voice call signs normally consist of which of the following types of communication?
1. Spoken words
 2. Unrelated letters
 3. Ship's name
 4. Letter/number combinations
- 6-32. What publication contains voice call signs for ships and other joint armed forces?
1. ACP 100
 2. ACP 113
 3. ACP 129
 4. JANAP 119
- 6-33. What publication contains the basic methods for establishing and conducting voice communication?
1. ACP 121
 2. ACP 125
 3. ACP 129
 4. ACP 131
- 6-34. You are a radiotelephone operator in station WC. Station AB has established a direct net. You have no traffic to send, but you want to ascertain that communications is possible. What should your reply to AB's answer to your call be?
1. THIS IS WC-ROGER-OVER
 2. THIS IS WC-OUT
 3. THIS IS WC-NO TRAFFIC-OVER
 4. THIS IS WC-NEGATIVE-OUT
- 6-35. Full calls are used under which of the following circumstances?
1. When opening a net
 2. Reopening a net
 3. Reporting into a previously established net
 4. All of the above
- 6-36. The NCS is establishing a net. In what order will subordinate stations answer?
1. By hull number, lowest to highest
 2. Alphabetically according to ship's name
 3. Alphabetically in voice call sign order
 4. By seniority
- 6-37. Which of the following information is the major part of a voice radio message?
1. Heading only
 2. Text only
 3. Ending only
 4. Heading, text, and ending
- 6-38. The procedure for conducting radio checks, repetitions, verifications are contained in what publication?
1. ACP 121
 2. ACP 125
 3. ACP 129
 4. ACP 131
- 6-39. By what method is a message executed before the stations called have an opportunity to verify or acknowledge?
1. Immediate executive
 2. Delayed executive
 3. Normal executive
 4. No response
- 6-40. What is a distinguishing characteristic of a tactical message transmitted for immediate execution?
1. The proword IMMEDIATE EXECUTE is spoken twice
 2. The text is transmitted twice
 3. The proword EXECUTE is omitted
 4. The proword STANDBY is omitted
- 6-41. In which of the following parts of an executive message is the executive signal sent?
1. Ending
 2. Heading only
 3. Text only
 4. Heading and text

- 6-42. What procedure uses a code word and number combination that is transmitted immediately to a station that has disclosed an essential element of friendly information?
1. Alert
 2. Beadwindow
 3. Net alert
 4. Direct net alert
- 6-43. Beadwindow increases security awareness among operators and is an overall improvement in the security of insecure voice radio.
1. True
 2. False
- 6-44. An advantage of allied flaghoist signaling procedures is speed in communicating. What is the major contributing factor toward that advantage?
1. All flaghoist signals have predetermined meanings
 2. Predetermined meanings are found in classified publications
 3. There is no possibility of transmission error
 4. There is no possibility of reception error
- 6-45. For what reason is flaghoist signaling an accurate means of communicating?
1. There is no possibility of transmission error
 2. The originator can visually reception
 3. Predetermined meanings are found in classified publications
 4. You can communicate simultaneously with all ships
- 6-46. The standard naval flag bag contains how many special flags and pennants?
1. 14
 2. 16
 3. 18
 4. 20
- 6-47. The standard naval flag bag contains a total of how many flags and pennants?
1. 38
 2. 48
 3. 58
 4. 68
- 6-48. Which of the following information should you hoist using a numeral pennant?
1. Operating signal
 2. Call
 3. Time signal
 4. Bearing
- 6-49. Special flags and pennants are used in tactical maneuvers to direct changes in speed, position, formation, and course.
1. True
 2. False
- 6-50. What are the two swallowtail flags in your flag bag?
1. PAPA and OSCAR
 2. WHISKEY and CHARLIE
 3. ALFA and BRAVO
 4. FIVE and ZE-RO
- 6-51. What are the four signal flags or pennants that bear a diagonal cross?
1. MIKE, VICTOR, XRAY, and FOUR
 2. ROMEO, UNIFORM, HOTEL, and KILO
 3. OSCAR, MIKE, ZULU, and VICTOR
 4. MIKE, VICTOR, FOUR, and FIVE
- 6-52. What numeral flags consist of horizontal stripes?
1. ONE, THREE, and SIX
 2. TWO, SIX, and SEVEN
 3. ONE, TWO, and THREE
 4. SEVEN, EIGHT, and NINE
- 6-53. Two special pennants contain a color unused in any other signal flags or pennants. What are the two pennants and what is the color?
1. DESIG and EMERG; orange
 2. PREP and STBD; green
 3. INT and TURN; orange
 4. PORT and STBD; green
- 6-54. What is the approximate length of a standard tackline?
1. 2 ft
 2. 3 ft
 3. 5 ft
 4. 6 ft
- 6-55. What is the purpose of including a TACK in a signal?
1. To avoid repetition
 2. To avoid ambiguity
 3. To avoid lengthiness
 4. To avoid deception

- 6-56 Where should you stow your signal flags and pennants when not in use?
1. Flag locker
 2. Flag bag
 3. Signal flag locker
 4. Signal bag
- 6-57 Your signal bridge has six signal halyards, three on each side of the mast. How should the inboard halyard on the port side be designated?
1. One port
 2. Two port
 3. Three port
 4. Six port
- 6-58 How should you recover a hoist that you have lost in the wind?
1. By the uphaul
 2. By the downhaul
 3. By the snap ring
 4. By the retriever
- 6-59 While standing watch on your signal bridge, you sight a signal being readied on another ship. What should you call out to your personnel to get ready to display the signal?
1. STAND BY
 2. STAND BY TO RECEIVE
 3. STAND BY FOR SIGNALS
 4. STAND BY YOUR BAG
- 6-60 When you have called out a complete hoist that your ship is to repeat, what should you next call out?
1. STAND BY YOUR BAG
 2. EXECUTE
 3. GOING UP
 4. TAKE IT UP
- 6-61. What term identifies the section of halyard that is bent to the lowest flag or pennant in a hoist?
1. The bitter end
 2. The loose end
 3. The uphaul
 4. The downhaul
- 6-62. You are on the flag bag. When you have bent on all flags in a signal to be hoisted, what should you call out to the uphaul?
1. READY
 2. READY TO HOIST
 3. TAKE IT UP
 4. HAUL AWAY
- 6-63. A flaghoist is said to be closed up when it reaches what point?
1. The bitter end
 2. The point of hoist
 3. The uphaul limit
 4. The downhaul limit
- 6-64. What term identifies a signal that is as high as it can be raised?
1. Closed up
 2. At the top
 3. In the air
 4. Ready
- 6-65 Signals hoisted by the originator are normally hoisted closed up.
1. True
 2. False
- 6-66 A signal at the dip is one that is positioned at what distance up to the point of hoist?
1. One-fourth
 2. One-half
 3. Two-thirds
 4. Three-fourths
- 6-67 A flaghoist that answers or repeats the original signal should normally be hoisted in what position?
1. Closed up
 2. At the dip
 3. Port yardarm
 4. STBD yardarm
- 6-68 What term identifies the action of returning a flaghoist to the deck?
1. Terminated
 2. Hauled down
 3. Downhaul
 4. Returned
- 6-69 Best results are achieved in flaghoist communication when signals can be made as a single hoist and hauled down before another signal is hoisted.
1. True
 2. False
- 6-70 At what point should a flaghoist be broken if it is too long for one hoist?
1. At a TACK
 2. At the heading
 3. At the ending
 4. After the text

6-71. The flagship is showing signals from (a) the port yardarm, (b) the masthead, (c) the starboard yardarm, and (d) the triatic stay. In what order should you read these flaghoist signals?

1. (b), (d), (c), (a)
2. (b), (c), (a), (d)
3. (b), (a), (c), (d)
4. (b), (c), (a), (c)

6-72. What position is a flaghoist in if it is to be read before another that is flying at the same time?

1. Closed up
2. Hauled down
3. Superior
4. Inferior

IN ANSWERING QUESTIONS 6-73 THROUGH 6-75, YOU ARE BENDING ON A SIGNAL AS IT IS BEING CALLED OUT BY THE SPOTTER. SELECT THE CHRONOLOGICAL ORDER IN COLUMN B IN WHICH YOU SHOULD PERFORM THE ACTION IN COLUMN A.

	<u>A. ACTION</u>	<u>B. ORDER</u>
6-73.	Snap halyard to flag ring	1. 1
6-74.	Pull out tail line snap	2. 2
6-75.	Pull ring out of its slot	3. 3

ASSIGNMENT 7

Textbook Assignment: "Allied Flaghoist Procedures" (continued), chapter 5, pages 5-6 through 5-16.

-
- 7-1. The person on the uphaul is hoisting a signal you have bent on. What action should you take in regard to the downhaul?
1. Keep it under a slight strain
 2. Keep it as taut as possible
 3. Keep it as loose as possible
 4. Loop it around a belaying pin
- 7-2. PQS for the flag bag operator is contained in what booklet?
1. NAVEDTRA 12104
 2. NAVEDTRA 43354A
 3. NAVEDTRA 72104
 4. NAVEDTRA 82104
- 7-3. A flaghoist signal is being hauled down. What action do you take with the uphaul while the downhaul lowers the hoist?
1. Let it go
 2. Loop it around a belaying pin
 3. Keep it under a slight strain
 4. Keep it as taut as possible
- 7-4. What should the spotter call out when all flags from a signal are stowed and the halyards are made ready for the next hoist?
1. READY
 2. READY ON THE STBD/PORT BAG
 3. FLAG BAG READY
 4. I AM READY
- 7-5. A flaghoist message contains how many parts?
1. One
 2. Two
 3. Three
 4. Four
- 7-6. A flaghoist signal from the flag ship that has no call should be considered as addressed to which units?
1. All units within visual contact
 2. All units in company including those beyond visual contact
 3. Only those units in the main body
 4. Those designated by prearrangement
- 7-7. Where should you hoist a heading in conjunction with a flaghoist message?
1. At the port yardarm
 2. At the starboard yardarm
 3. At the masthead
 4. In a superior position to the text
- 7-8. What substitute is used over a call to indicate that the signal is for general information, no specific address, no answer required?
1. FIRST SUB
 2. SECOND SUB
 3. THIRD SUB
 4. FOURTH SUB
- 7-9. To indicate to a unit that the accompanying signals are taken from ATP 2, Vol. II, what substitute should you hoist above the signal?
1. FIRST SUB
 2. SECOND SUB
 3. THIRD SUB
 4. FOURTH SUB
- 7-10. The heading of a flaghoist message usually consists of which of the following elements?
1. The originator and action addressee
 2. The action addressee only
 3. The originator only
 4. The originator and info addressee

- 7-11. What flag is used to indicate an exempt addressee in a flaghoist message?
1. PREP
 2. ECHO
 3. NEGAT
 4. CORPEN
- 7-12. What flag is used to indicate an information addressee in a flaghoist message?
1. WHISKEY
 2. INDIA
 3. FOXTROT
 4. ECHO
- 7-13. The text of flaghoist messages will consist of the prescribed signals and plain language necessary to convey the subject matter expressed by the originator.
1. True
 2. False
- 7-14. What publication is the origin of most tactical communications between allied naval units?
1. ATP 1, Vol. I
 2. ATP 1, Vol. II
 3. ATP 2, Vol. I
 4. ATP 2, Vol. II
- 7-15. What is the overall security classification of ATP 1, Vol. II?
1. Confidential
 2. Secret
 3. FOUO
 4. NATO Restricted
- 7-16. How many flag action tables are contained in ATP 1, Vol. II?
1. Six
 2. Two
 3. Five
 4. Four
- 7-17. What tables are used primarily to expand the meaning of certain basic groups?
1. Chapter
 2. Supplementary
 3. Suffix
 4. Vocabulary
- 7-18. What group is a two-letter group allocated to a particular chapter and the main vocabulary from which all signals in that chapter are derived?
1. Basic
 2. Chapter
 3. Supplementary
 4. Page
- 7-19. What type of group consists of a chapter group followed by one or more figures?
1. Basic
 2. Suffix
 3. Supplementary
 4. Page
- 7-20. Which of the following items may be used to supplement or modify signals from ATP 1, Vol. II?
1. Prosigns
 2. Prowords
 3. Plain language
 4. Code words
- 7-21. What are the three governing pennants?
1. INTERROGATIVE, PREPARATIVE, and NEGATIVE
 2. INTERROGATIVE, PREPARATIVE, and CODE
 3. INTERROGATIVE, NEGATIVE, and ANSWER
 4. INTERROGATIVE, NEGATIVE, and CODE
- 7-22. When the governing pennant is to be used to govern only one of several signal groups, it must be separated by TACK from that group.
1. True
 2. False

IN ANSWERING QUESTIONS 7-23 THROUGH 7-27, SELECT FROM COLUMN B THE SIGNAL THAT INDICATES THE MEANING IN COLUMN A (BASIC SIGNAL GROUP FOR FUELING IS R01).

	<u>A. MEANING</u>	<u>B. SIGNAL</u>
7-23.	I AM READY TO REFUEL	1. BB TACK R01
7-24.	I HAVE REFUELED	2. BE TACK R01
7-25.	REPORT WHEN READY TO REFUEL	3. BF TACK R01
7-26.	I AM REFUELING	4. BA TACK R01
7-27.	REFUEL IS COMPLETED	

7-28. In the signal BK-EL4-AD10-CM1, which group(s) is/are governed by BK?

1. EL4 only
2. EL4 and AD10 only
3. EL4 and CM1 only
4. EL4, AD10, and CM1

7-29. Your ship received a signal from a junior ship requesting permission to proceed on duties assigned. With what signal should your ship reply to grant permission?

1. A
2. C
3. Permission granted
4. OK

7-30. When a governing group applies to two or more signals following it, what governing group is inserted after the last signal to which it applies?

1. BB
2. BE
3. BU
4. BX

7-31. To hoist a signal using plain language, what flag should precede the signal?

1. CODE
2. DESIG
3. EMERG
4. FORM

7-32 Whenever international groups are used alone in flaghoist communication, international procedure is to be used in answering.

1. True
2. False

7-33 When a signal from the supplementary table (except for supplementary table X) is used by itself, it should be preceded by what governing group?

1. BA
2. BC
3. BV
4. BZ

7-34. What substitute should precede signals from supplementary table X?

1. FIRST SUB
2. SECOND SUB
3. THIRD SUB
4. FOURTH SUB

QUESTIONS 7-35 THROUGH 7-46 PERTAIN TO THE USE OF MANEUVERING FLAGS. THE WORD FLAGS FOR ITEMS IN THIS SECTION INDICATES BOTH FLAGS AND PENNANTS EXCEPT WHERE PENNANTS ARE SPECIFIED.

7-35 Which of the following are basic maneuvering flags?

1. DESIG, SPEED, SCREEN
2. FORM, CORPEN, STATION
3. TURN, PORT, PREP
4. STBD, PORT, EMERG

7-36 A complete maneuvering tactical signal consists of one or more maneuvering flags and pennants followed by which of the following items?

1. Alphabet flags
2. Alphabet and numeral flags
3. Numeral flags
4. Numeral pennants

7-37 To construct a tactical signal indicating a true course or bearing, besides the maneuvering flag, what flag(s) should you hoist?

1. One numeral flag
2. Two numeral flags
3. Three numeral flags
4. Four numeral flags

- 7-38. When fewer than three flags are hoisted in a maneuvering signal, they indicate relative bearing.
1. True
 2. False
- 7-39. The OOD orders you to hoist SPEED 25 ANSWER. What speed does this signal indicate?
1. 2.55 knots
 2. 25.55 knots
 3. 25.0 knots
 4. 25.5 knots
- 7-40. The OOD orders you to hoist the signal to indicate a speed of 15.6 knots. What should you hoist?
1. SPEED ONE FIVE SIX
 2. SPEED ONE FIVE ANS SIX
 3. SPEED ONE FIVE TACK SIX
 4. SPEED TACK ONE FIVE SIX
- 7-41. To alter the course of a formation in columns, what maneuvering flag should you hoist as the first flag of the signal?
1. CORPEN
 2. FORM
 3. STATION
 4. TURN
- 7-42. What signal should you hoist to indicate a wheel of 45° to port?
1. CORPEN PORT 45
 2. CORPEN PORT 4 ANS
 3. TURN 45
 4. TURN PORT 45
- 7-43. What is the correct hoist to indicate that addressees are to execute a simultaneous 25° course change to STBD?
1. CORPEN STBD 2 ANS
 2. CORPEN STBD 25
 3. TURN STBD 2 ANS
 4. TURN STBD 25
- 7-44. What is the maneuvering flag used to rearrange ships on an indicated line of bearing from the guide?
1. FORM
 2. PORT
 3. STBD
 4. TURN
- 7-45. How should you construct a signal directing ships to form on a relative bearing of 090° from the starboard side of the guide?
1. FORM STBD 9
 2. FORM STBD 09
 3. FORM 090
 4. FORM STBD 090
- 7-46. A ship is joining up and the JOOD orders you to hoist a signal indicating its position in the formation. What maneuvering flag should you hoist as the first flag of the signal?
1. CORPEN
 2. FORM
 3. STATION
 4. TURN
- QUESTIONS 7-47 THROUGH 7-49 PERTAIN TO THE USE OF SUBSTITUTES.
- 7-47. For what purpose are substitutes included in flaghoist signals?
1. To reduce signal transmission
 2. To prevent flag repetition
 3. To speed transmission time
 4. To enhance security
- 7-48. What is the proper use of substitutes for bending on the signal DELTA BRAVO TACK BRAVO DELTA BRAVO?
1. DB TACK 1ST 2ND 3RD
 2. DB TACK 2ND 3RD 1ST
 3. DB TACK 2ND 1ST 3RD
 4. DB TACK 1ST 2ND 4TH
- 7-49. When a tackline separates hoist components, it is regarded in the substitute count.
1. True
 2. False
- 7-50. What is the unit of reference for range?
1. Miles
 2. Hundreds of yards
 3. Feet
 4. Hundreds of feet

QUESTIONS 7-51 THROUGH 7-57 PERTAIN TO THE SIGNALING OF TIMES AND DATES.

- 7-51. TANGO is included in a flaghoist signal to indicate the time of
1. execution
 2. receipt
 3. transmission
 4. relaying
- 7-52. In the text of a signal, times are expressed as four numbers; the first two denote the date and the second two the hour.
1. True
 2. False
- 7-53. How should you transmit a time of 1230 in conjunction with a signal?
1. 1230T
 2. T1230
 3. T12ANS
 4. 12ANST
- 7-54. You are to signal another ship that it is to commence refueling at 1200 and be completed by 1300. If the basic group signal for refueling is RO, what signal should you hoist?
1. T12 TACK RO TACK 13
 2. RO TACK 13T12
 3. RO TACK T12T13
 4. RO TACK T13 TACK T12
- 7-55. How is BT used to indicate that all groups of a display are to be governed by a single time group?
1. It is flown first, followed by TACK
 2. It immediately follows the final group
 3. It is flown both first and last
 4. It is flown last, preceded by TACK
- 7-56. What is the time zone indicator for 52 1/2E to 67 1/2E?
1. +4D
 2. -4D
 3. +5R
 4. -5R

- 7-57. A ship that is in zone minus 12 and keeping daylight saving time should use what time zone indicator?
1. -12M
 2. -12N
 3. -13M
 4. -13N
- 7-58. How should single flags and pennants be separated if you are displaying more than one on the same halyard?
1. By ANS
 2. By TANGO
 3. By TACK
 4. By ALFA

QUESTIONS 7-59 THROUGH 7-65 PERTAIN TO FLAGHOIST PROCEDURES.

- 7-59. How should you answer an originator's flaghoist signal?
1. Repeat the signal close up
 2. Repeat the signal at the dip
 3. Repeat and immediately lower the signal
 4. Hoist ROMEO closed up
- 7-60. How should you acknowledge an originator's flaghoist signal?
1. Close up the repeated hoist
 2. Repeat the hoist at the dip
 3. Haul down the repeated hoist
 4. Hoist ROMEO
- 7-61. During inclement weather, what flag or pennant should a small ship hoist instead of repeating a signal flag for flag?
1. EMERG
 2. ANSWER
 3. FORM
 4. PREP
- 7-62. When you desire to question a hoist, what pennant should you hoist?
1. PREP
 2. INT
 3. EMERG
 4. ANSWER

- 7-63. What signal should you hoist to indicate to a ship that the signal you are flying is repeated incorrectly?
1. INT 1
 2. INT 2
 3. INT 3
 4. INT 4
- 7-64. NEGAT without a call preceding it cancels all signals without a call.
1. True
 2. False
- 7-65. If only one of several signals under the same call is to be canceled, it does not have to be repeated when preceded by NEGAT under the same call.
1. True
 2. False
- 7-66. What operating signal means HOIST THE FOLLOWING SIGNAL?
1. ~~Z~~JI
 2. ~~Z~~JL
 3. ~~Z~~JJ
 4. ~~Z~~UI
- 7-67. Which of the following is an example of a special flaghoist task organization call sign?
1. Three three 6
 2. Three 36
 3. 3 three 6
 4. 3 three six
- 7-68. Your ship has visual responsibility for the ship astern. You have repeated a signal from the OTC, but the OTC hauls down the signal before the ship astern repeats the signal. How should you relay this to the astern ship?
1. Rehoist close up
 2. Rehoist at the dip
 3. By flashing light
 4. By semaphore
- 7-69. You receive the signal 1ST Cp1 Dp4 Dp6 OOP. To which addressee(s) should you relay this signal?
1. Dp4 only
 2. Cp1, Dp4 only
 3. Dp4, Dp6 only
 4. Cp1, Dp4, Dp6
- 7-70. Cp1 originates a message to Lp3 that is to be relayed by your ship, Dp5. The length of the message requires the use of two hoists. Cp1 sends: 1ST Cp1 TACK Lp3 OP. In what way will your hoist differ from Cp1?
1. The first hoist will be at the dip
 2. The second hoist will be at the dip
 3. The first hoist will not include p1
 4. The second hoist will substitute p3 for p2
- QUESTIONS 7-71 THROUGH 7-75 PERTAIN TO MAKING UP A FLAG FOR THE BREAK.
- 7-71. Which of the following flags or pennants should always be made up for the break?
1. UNIFORM (Anchoring)
 2. DELTA (Degaussing)
 3. OSCAR (Man Overboard)
 4. FORM (Refuse Barge)
- 7-72. To start, how many times should you fold the flag and in what direction?
1. Once to your left
 2. Once to your right
 3. Twice to your left
 4. Twice to your right
- 7-73. How far should you fold the fly end of the flag?
1. One-fourth
 2. One-third
 3. One-half
 4. Three-quarters

7-74. What procedure should you follow to make sure the flag will not unroll until needed?

1. Wrap a turn of white twine near each end
2. Wrap two turns of white twine near each end
3. Wrap a turn of the tail line
4. Wrap two turns of the tail line

7-75. The national ensign should always be made up for the break.

1. True
2. False

ASSIGNMENT 8

Textbook Assignment: "International Signaling," chapter 6, pages 6-1 through 6-20.

- 8-1. In communicating with merchantmen, Allied procedures may be used.
1. True
 2. False
- 8-2. What information is contained in chapter 3 of the *International Code of Signals*?
1. Distress signals
 2. Radiotelephone procedures
 3. Medical signals
 4. Signaling instructions
- 8-3. What is the group of letters and figures assigned to each station by its administration?
1. Station of origin
 2. Station of destination
 3. Receiving station
 4. Identity signal
- 8-4. What is the number of flags contained in an international flag bag?
1. 36
 2. 38
 3. 40
 4. 42
- 8-5. In international signaling, the standard rate of signaling by flashing light is how many letters per minute?
1. 25
 2. 30
 3. 35
 4. 40
- 8-6. When radiotelephone is used operators should comply with regulations located in what publication?
1. ACP 121
 2. ACP 125
 3. ACP 129
 4. *Radio Regulations of the International Telecommunications Union*
- 8-7. How should you transmit the name of a ship or a specific place?
1. Use the complement tables
 2. Spell it out
 3. Abbreviate the name
 4. Refer to the nationality code
- 8-8. How should you indicate numbers in an international flaghoist signal?
1. Use numeral pennants
 2. Use numeral flags
 3. Spell them out
 4. Abbreviate them
- 8-9. When signaling a number to a merchant ship, what flag or pennant should you hoist to indicate a decimal point?
1. DELTA
 2. FIRST SUB
 3. ANS
 4. ZERO
- 8-10. How should you transmit the number 6.6 to a merchantman by flashing light?
1. SIX POINT SIX
 2. SIX ANS SIX
 3. SIX AAA SIX
 4. SIX AA AA SIX

- 8-11. A three-figure number preceded by the letter A has what meaning?
1. Bearing
 2. Course
 3. Distance
 4. Range
- 8-12. An international four-character signal that begins with the letter C refers to what type of course?
1. True
 2. Relative
 3. Magnetic
 4. Compass
- 8-13. What should you hoist to indicate the 15th of December, 1996, when communicating using international signaling procedures?
1. D1512
 2. D151296
 3. D911215
 4. D121596
- 8-14. How should you signal your latitude of 45°38'N using international procedures when there is no possibility of confusion?
1. N4538
 2. 4538N
 3. L4538N
 4. 4538L
- 8-15. You are to notify a passing merchant ship by an MZ signal that navigation is dangerous in the area around latitude 45°36'N and longitude 164°15'W. What signal should you hoist?
1. MZ L4536N G16415W
 2. MZ 4536G 16415W
 3. L4536N G16415W MZ
 4. G4536N L16415W MZ
- 8-16. What signal should you hoist to indicate a distance of 5 nautical miles?
1. Rp5
 2. p0p5
 3. p0p5NM
 4. p5M
- 8-17. What is the correct international signal for a course of 215° true and a speed of 22 knots?
1. C215 22V
 2. C215 V22
 3. C215 22S
 4. C215 S22
- 8-18. In international procedures, what signal indicates 35 minutes before midnight, local time?
1. T1125
 2. T2325
 3. 1125Z
 4. Z2325
- 8-19. In international communications, what serves as a convenient reference number?
1. Time of origin
 2. Time of receipt
 3. Identity signal
 4. Date
- 8-20. Upon entering a foreign port, you see that the harbor master's building displays YV1 on one halyard and a second signal on an adjacent halyard. What does this signal indicate?
1. It asks if the ship needs a pilot
 2. It asks the ship's destination
 3. It signals that the adjacent signal is based on the local signal code
 4. It signals that the adjacent signal is based on Allied communication procedures
- 8-21. What flag should you hoist to indicate that the following signal groups are from the *International Code of Signals*?
1. CODE
 2. STBD
 3. INTERCO
 4. 2ND SUB

- 8-22. When you communicate with a merchant ship, what is the maximum number of hoists you should have flying at one time?
1. One
 2. Two
 3. Three
 4. Two plus a tackline
- 8-23. While under way, the OOD orders you to establish communication with a British merchant ship. Not knowing her identity signal, what should you hoist?
1. ANS and your call sign
 2. ANS alone at the dip
 3. CS and ANS
 4. CS and your call sign
- 8-24. A passing merchant ship transmits a signal to your ship by flaghoist. How should you indicate that you understand the signal?
1. Hoist the same signal
 2. Haul down your call
 3. Haul down ANS
 4. Close up ANS
- 8-25. A merchant ship has sent your ship a signal. You have indicated that the signal is understood, and the merchantman hauls down the hoist. What action should you take at this point?
1. Lower ANS to the dip
 2. Lower the repeated call
 3. Haul down the signal
 4. Haul down ANS
- 8-26. What signal should you hoist to indicate to a merchant ship that you have received the signal but do not understand it?
1. **ZQ**
 2. **ZL**
 3. **ZK**
 4. **ZP**
- 8-27. To cancel your last signal to a merchant ship, what signal should you hoist?
1. **ZP**
 2. **ZQ**
 3. **YN**
 4. **YO**
- 8-28. In response to your flaghoist signal to a merchant ship, the merchant ship hoists **ZL**. Upon checking, you discover you have sent QN2 rather than the intended QN1. How should you correct your hoist?
1. Hoist QN1 immediately
 2. Hoist **ZP** and then QN1
 3. Hoist **ZP** and QN1 simultaneously
 4. Hoist QN1 and then **ZP**
- 8-29. How should you signal AAOA using international flaghoist procedures?
1. A 1st SUB O 1st SUB
 2. A 1st SUB O 2nd SUB
 3. A 1st SUB O 3rd SUB
 4. A 2nd SUB O 1st SUB
- 8-30. How should you signal 1131 local time by flaghoist to a merchant ship?
1. T 1 1st SUB 3 2nd SUB
 2. T 1 1st SUB 3 1st SUB
 3. **Z** 1 1st SUB 3 2nd SUB
 4. **Z** 1 1st SUB 3 1st SUB
- 8-31. What should you hoist to indicate that a portion of an international flaghoist signal is to be read as plain language?
1. Y ANS
 2. **YZ**
 3. ANS Y
 4. **ZZ**
- 8-32. What are the four parts of an international flashing light message?
1. Call, identity, heading, text
 2. Call, identity, heading, ending
 3. Call, identity, text, ending
 4. Call, identity, preamble, ending

8-33. A passing commercial vessel transmits your call sign by flashing light. How should you respond?

1. Hoist the answer pennant
2. Hoist your call sign
3. Flash the answering signal
4. Flash your call sign

8-34. After you respond to an international general call, the transmitting ship flashes DE and its name VICTOR. What should you transmit at this point?

1. Your call sign only
2. DE and your call sign
3. DE VICTOR only
4. DE VICTOR and your call sign

8-35. When communicating using international flashing light, you should repeat for each word or group by flashing what signal?

1. R
2. T
3. K
4. M

8-36. To acknowledge a correctly received repetition, you should transmit what signal?

1. T
2. K
3. R
4. OK

8-37. The SS VICTOR completes a message to your ship by making \overline{AR} . How should you respond to this signal?

1. Flash R
2. Repeat \overline{AR}
3. Haul down ANS
4. Hoist your identity signal

IN ANSWERING QUESTIONS 8-38 THROUGH 8-41, SELECT FROM COLUMN B THE INTERNATIONAL FLASHING LIGHT PROCEDURE SIGNAL THAT CORRESPONDS WITH THE MEANING IN COLUMN A.

A. MEANING

B. SIGNAL

8-38. Erase signal

1. $\overline{AA} \overline{AA} \overline{AA}$

8-39. Answering signal

2. \overline{AAA}

8-40. General call

3. \overline{TTTT}

8-41. Decimal point

4. \overline{EEEEEE}

8-42. What should you transmit to call another ship using international sound signaling?

1. $\overline{AA} \overline{AA} \overline{AA}$
2. The addressee's identity
3. K
4. DE and your call sign

8-43. If a merchant ship calls you by sound, what signal should you send in reply?

1. R R R
2. K and your call sign
3. \overline{TTTT}
4. CS

8-44. How should you repeat for an international sound signal?

1. Transmit T after each word
2. Transmit T after the complete signal
3. Transmit K after the complete signal
4. Transmit R after the complete signal

8-45. When communicating using radiotelephone, you should spell difficult names of stations.

1. True
2. False

- 8-46. What signal group is used to call all stations in the vicinity?
1. YN
 2. CS
 3. CQ
 4. CN
- 8-47. When communicating using radiotelephone procedures, what should you use to indicate that the following groups are from the *International Code of Signals*?
1. ANS
 2. INTERCO
 3. SIGNALS
 4. INTERNATIONAL
- 8-48. An approaching freighter hoists K1 to indicate that the master wishes to communicate by what method?
1. Radiotelephone
 2. Morse signaling by hand flags or arms
 3. Flaghoist
 4. Flashing light
- 8-49. Upon receiving the international signal K1, what should you hoist to indicate you are ready to receive the message?
1. YS1
 2. YS2
 3. AA
 4. ANS
- 8-50. While you are in coastal waters, an overtaken commercial vessel is displaying ALFA. For what reason should you remain clear of this vessel?
1. Dangerous goods are on board
 2. A diver is down
 3. The vessel is engaged in trawling
 4. The vessel is maneuvering with difficulty
- 8-51. What should a merchant ship hoist to warn your ship that it is maneuvering with difficulty?
1. D
 2. F
 3. P
 4. V
- 8-52. Commercial fishermen are given a wide berth when trawling or otherwise using nets. Depending on the type of activity in which they are engaged, such craft should display which single-letter signals?
1. G, T, ~~Z~~
 2. G Q, V
 3. T, U, ~~Z~~
 4. F, G, Y
- 8-53. While under way, your ship is stopped by the commanding officer. To avoid confusion on the part of merchant ship masters, you should hoist what signal?
1. L
 2. M
 3. S
 4. Y
- 8-54. What single-letter signal should you hoist to inform a merchant ship that she is running into danger?
1. K
 2. R
 3. T
 4. U
- 8-55. What single-letter signals have special meanings as landing signals for small boats with crews or persons in distress?
1. B and D
 2. K and S
 3. U and W
 4. X and ~~Z~~
- 8-56. The list of medicament tables should be used when medications are prescribed. What table in chapter 3 of Pub 102 identifies the table?
1. M-1
 2. M-2
 3. M-3
 4. M-4

- 8-57. For special treatment signals, what section of chapter 3 of Pub 102 should you use?
1. 3A
 2. 3B
 3. 3C
 4. 3D
- 8-58. What section of chapter 3 of Pub 102 signifies the method of administration and dose required to give to a patient?
1. 3D-1
 2. 3D-2
 3. 3D-3
 4. 3D-4
- 8-59. While on the signal bridge at night, you hear a ship's foghorn. You know the nearby ship needs help because she sounds the horn in what manner?
1. Every 30 seconds
 2. Each minute
 3. At 2-minute intervals
 4. Continuously
- 8-60. In what pattern does a merchant ship fire red rockets to indicate it is in distress?
1. One at a time
 2. Two at a time
 3. Three at a time
 4. Four at a time
- 8-61. What is the international radiotelephone signal indicating that the originating ship is in distress?
1. SOS
 2. PAN
 3. MAYDAY
 4. NC
- 8-62. What is the international code signal for distress?
1. CN
 2. NC
 3. SO
 4. OS
- 8-63. A vessel in distress indicates its difficulty by use of a smoke signal. What color is the smoke?
1. Blue
 2. Green
 3. White
 4. Orange
- 8-64. If an aircraft circles your ship, crosses your course close ahead, and then heads eastward, what is the pilot indicating?
1. Your ship's assistance is no longer needed
 2. A ship or craft in distress lies to the east
 3. Flares will be dropped in the east
 4. Survivors have been picked up
- 8-65. An aircraft crosses your wake close astern while the pilot alters propeller pitch. The pilot then flies eastward. What is the pilot indicating?
1. The ship should follow him/her
 2. The assistance of the ship is no longer required
 3. A ship or craft is in distress to the east
 4. There are no survivors
- 8-66. What radiotelephone prefix should you transmit to indicate that you have a very urgent message to transmit concerning the safety of your ship?
1. MAYDAY
 2. PAN
 3. SECURITE
 4. SAFETY
- 8-67. What radiotelephone prefix should you transmit to indicate that you have an important meteorological warning message?
1. PAN
 2. SAFETY
 3. SECURITE
 4. MAY DAY

- 8-68. What is the purpose of the INCSEA agreement?
1. To enable the United States and Russia to communicate
 2. To reduce the number of unintended serious confrontations between the United States and Russia
 3. To reduce the number of confrontations between Russia and the United Kingdom
 4. To reduce the number of confrontations between the United States and the United Kingdom
- 8-69. What signal should you use to acknowledge a signal taken from the INCSEA agreement?
1. ~~ZL~~p1
 2. YVp1
 3. YVp1-~~ZL~~p1
 4. CODE Yvp1-~~ZL~~p1
- 8-70. To cancel a signal from the INCSEA agreement, what signal should you hoist?
1. CODE YN or ~~ZP~~
 2. CODE YN or ~~ZL~~
 3. CODE ~~ZL~~ or ~~ZP~~
 4. CODE NEGAT
- 8-71. What signals are reserved for very urgent, important, or very common usage?
1. Single-letter
 2. Two-letter
 3. Three-letter
 4. Four-letter
- 8-72. You receive the signal I AM DAZZLED BY YOUR SEARCHLIGHT. EXTINGUISH IT OR LIFT IT. What should you do to encode the signal?
1. Add a complement
 2. Pick out the key word and locate it in the index
 3. Look in the two-letter signal section
 4. Look for it in the glossary
- 8-73. What complement table should you use to locate "fire-fighting appliance"?
1. 1
 2. 2
 3. 3
 4. 4

ASSIGNMENT 9

Textbook Assignment: "Convoy Communications" and "Watchstanding Duties," chapters 7 and 8, pages 7-1 through 8-6.

- 9-1. Convoys are usually made up of ships of many different nations, traveling in company for mutual safety and manned by people of many different languages.
1. True
 2. False
- 9-2. What will the Naval Control of Shipping Organization (NCSORG) control in the event of war or national emergency?
1. Voyage itinerary
 2. Maintenance repair
 3. Ship movement
 4. Allocation of employment
- 9-3. Which of the following functions will NOT be assumed by the Civil Direction of Shipping Organization in the time of war or national emergency?
1. Loading and discharging
 2. Maintenance and repair
 3. Harbor movement and storing
 4. Putting ships in columns outside the harbor
- 9-4. The control that NCSORG exercises over shipping includes tactical diversions, movement reports, ship routing, and convoy organization.
1. True
 2. False
- 9-5. What naval commander is responsible for the movement and protection of allied ships within his/her area?
1. CDSORG
 2. NCSORG
 3. OCA
 4. NCSO
- 9-6. Who makes the decision whether to sail ships in convoy or as independents?
1. OCA
 2. Convoy commodore
 3. NCSO
 4. CDSORG
- 9-7. Who coordinates and controls the routing and movement of merchant ships and convoys within an assigned or adjacent port area?
1. NCSO
 2. OCA
 3. Convoy commodore
 4. Reporting officer
- 9-8. Who is responsible for Naval Control of Shipping measures both in port and at sea?
1. Reporting officer
 2. Area commander
 3. NCSO
 4. OCA
- 9-9. What officer is the OCA's representative at a port?
1. Reporting officer
 2. Area commander
 3. NCSO
 4. Convoy commodore
- 9-10. What officer is responsible for the defense of the convoy?
1. Convoy commodore
 2. Vice commodore
 3. OTC
 4. NSC

- 9-11. What officer is responsible for the internal operations of the convoy?
1. Vice commodore
 2. Rear commodore
 3. Convoy commodore
 4. OTC
- 9-12. What officer is responsible for the safe navigation of the convoy?
1. Ship's master
 2. Convoy commodore
 3. Vice commodore
 4. Rear commodore
- 9-13. What officer makes the decisions on the placement of ships within the formation after the ships leave port?
1. Escort force commander
 2. NCSO
 3. OTC
 4. Convoy commodore
- 9-14. What officer assumes the duty as convoy commodore if the convoy commodore's ship becomes incapacitated?
1. OTC
 2. NCSO
 3. Vice commodore
 4. Rear commodore
- 9-15. What flag is flown to identify the commodore's ship when a convoy is forming or reforming?
1. CHARLIE
 2. XRAY
 3. YANKEE
 4. ZULU
- 9-16. The convoy commodore informs your ship that she is to assume the guide. What flag should you hoist?
1. GOLF
 2. XRAY
 3. ZULU
 4. Your largest merchant ensign
- 9-17. In the broad convoy formation, you are the first ship in the fourth column. What would be your ship number?
1. 014
 2. 041
 3. 14
 4. 41
- 9-18. In a large formation, what type of ships are designated to relay messages from the commodore?
1. Routing
 2. Relay
 3. Light repeating
 4. Visual guard
- 9-19. If the convoy guide becomes disabled, the leading ship of the next column to starboard immediately becomes guide.
1. True
 2. False
- 9-20. The convoy guide and column guides change when the convoy alters course by which of the following methods?
1. Wheeling
 2. All ships turning simultaneously less than 90°
 3. All ships turning simultaneously more than 90°
 4. Column leaders turning simultaneously, the remaining ships in succession
- 9-21. Assume that five columns of ships are sailing in convoy on course 090°T and that the convoy guide is the leading ship of the middle column. The convoy commodore orders all ships to turn simultaneously to course 130°T. Which ship is the convoy guide when the course change is completed?
1. The lead ship in the port column
 2. The lead ship in the starboard column
 3. The lead ship in the middle column
 4. The rear ship in the middle column

9-22. While forming up, what should each ship hoist and keep flying until all ships are on station?

1. The STATION pennant
2. Her convoy internal call sign
3. Her international call sign
4. Her largest merchant ensign

9-23. In a convoy formation, what is the primary means of communication?

1. Flashing light
2. Colored light
3. Radioteletype
4. Radiotelephone

9-24. What publication should you use for voice radio communication procedures while in a convoy formation?

1. ATP 1, volume I
2. ATP 1, volume II
3. ATP 2, volume II
4. Pub 102

9-25. What publication should you use to find the correct pronunciation for the phonetic alphabet?

1. ATP 1, volume I
2. ATP 2, volume I
3. ATP 2, volume II
4. Pub 102

9-26. What proword used in convoy formation indicates that you are to carry out antijamming procedures?

1. ALARM
2. ALERT
3. KICK
4. REPEAT

IN ANSWERING QUESTIONS 9-27 THROUGH 9-30, SELECT FROM COLUMN B THE SPECIAL CONVOY CALL SIGN THAT REPRESENTS THE INDIVIDUAL IN COLUMN A.

A. INDIVIDUAL

B. CALL SIGN

9-27. OTC

1. COLT

9-28. Commodore

2. BOSS

9-29. Vice commodore

3. BULL

9-30. Rear commodore

4. CALF

9-31. What special convoy call sign should you use to call all escort ships?

1. SODA
2. GANG
3. PLANK
4. LAZY

9-32. You are on the ship that is carrying the escort commander, and you desire to advise other ships that you will take your signal from ATP 2, volume II. What signal should you hoist to indicate this information?

1. 1st SUB
2. 2nd SUB
3. 3rd SUB
4. 4th SUB

9-33. A flaghoist without a call is addressed to the convoy commodore when made by ships in the convoy.

1. True
2. False

9-34. In convoy communications, why are flag signals repeated flag for flag?

1. To increase speed
2. Merchant ships do not carry 4th substitute
3. To avoid confusion
4. To increase reliability

- 9-35. You send a message by flashing light but you do NOT wish the ships in the convoy to answer. What prosign preceding the call should you use?
1. BBBB
 2. FFFF
 3. HHHH
 4. NNNN
- 9-36. Which of the following situations warrants the use of the executive method of signaling?
1. A report to all ships that the convoy is entering enemy waters
 2. An order to assume plane guard
 3. An order to refuel
 4. An order to all ships to make a simultaneous course change
- 9-37. What pyrotechnic signal should a ship fire if she sights a previously undetected enemy submarine?
1. Two red rockets
 2. Two white rockets in quick succession
 3. Two white rockets in 1-minute intervals
 4. Two white rockets in 2-minute intervals
- 9-38. To what individual does the master report all defects in communications equipment that can NOT be repaired on board?
1. OTC
 2. NCSO
 3. OCA
 4. NCSORG
- 9-39. The three-letter signal vocabulary in chapter 12 of ATP 2, volume II, begins with what letter?
1. A
 2. P
 3. X
 4. Z
- 9-40. What kind of time is used in all convoy communication?
1. Local time
 2. Greenwich mean time
 3. Zone time
 4. Apparent time
- 9-41. You are in formation and you lose a man overboard; you should maneuver your ship to pick up the individual.
1. True
 2. False
- 9-42. What is the yardarm arrangement required by an examination ship at night to indicate that the port is closed?
1. Three fixed white lights
 2. Three fixed green lights
 3. Three fixed red lights
 4. Three fixed blue lights
- QUESTIONS 9-43 THROUGH 9-74 PERTAIN TO SIGNALMAN WATCH STANDING DUTIES.
- 9-43. What should be your primary concern(s) as a Signalman supervisor?
1. Always keeping a person available at the flag bag
 2. Traffic handling and watch discipline
 3. Keeping a close check on signal publications in use
 4. Actual operation
- 9-44. Which of the following requirements is NOT necessary for personnel assigned as signal supervisor?
1. Knowing watch stander's duties in various emergency bills
 2. Being thoroughly familiar with applicable instructions and publications pertaining to visual communications
 3. Being proficient in all forms of visual communication
 4. Being able to locate and use all radio central equipment
- 9-45. Under what conditions should the signal supervisor conduct training for watch personnel?
1. On a scheduled basis only
 2. As practicable under operating conditions
 3. Immediately after every signal sent and received
 4. When maneuvers begin and the pace is rapid

- 9-46. As signal supervisor under way, you should report all but which of the following incidents to the bridge?
1. A ship in company putting up a signal
 2. A casualty to a 12" searchlight
 3. Maintenance to a 12" searchlight
 4. The flagship executing a signal
- 9-47. Before becoming a Signaller supervisor, you should complete the PQS for visual communications.
1. True
 2. False
- 9-48. Before you are assigned as a Signaller of the watch, you should be knowledgeable in all of the following subject areas EXCEPT which one?
1. Special meanings of flags and pennants
 2. Recognition procedures
 3. Procedure signs and signals
 4. Being able to maneuver the ship for flaghoist purposes
- 9-49. During which of the following periods should you slack off halyards?
1. Fair weather
 2. Unlimited visibility
 3. Darkness
 4. Independent steaming
- 9-50. Which of the following actions should you always take if equipment fails while you are on watch?
1. Repair the equipment immediately
 2. Report the failure immediately
 3. Tag the equipment out of service
 4. Order repair parts
- 9-51. How often should you air your bunting?
1. Daily
 2. Weekly
 3. Monthly
 4. As needed to prevent mildew
- 9-52. Permission to air your flags must be obtained from what individual?
1. Signal officer
 2. OOD
 3. OTC
 4. CO
- 9-53. With regard to flaghoist communications, which of the following actions is NOT indicative of an alert signal force?
1. Hoisting and hauling down signals smoothly
 2. Bending on flags correctly the first time
 3. Speed in hauling up the hoist
 4. Hauling down signals in such a manner that they are allowed to stream to leeward or over the side
- 9-54. When you are signaling another ship at night using a 12" searchlight, what precautions should you observe?
1. Illuminating the ship's bridge and aircraft
 2. Pointing the light straight up
 3. Directing the light off water
 4. Signaling without the use of a reducer
- 9-55. You are aboard a carrier engaged in night flight operations. The commanding officer wishes to replenish at first light. If at all possible, what equipment should you use to signal the AO in company?
1. 12" searchlight
 2. Multipurpose light
 3. Yardarm blinkers
 4. Infrared
- 9-56. What should you use as a formation plot to keep track of ships in company?
1. Navigation chart
 2. Chalkboard
 3. Maneuvering board
 4. Plotting map

IN ANSWERING QUESTIONS 9-57 AND 9-58, REFER TO FIGURE 8-1 IN YOUR TEXTBOOK. YOU ARE ABOARD USS VICKSBURG (CG 69) AND YOU HAVE A MESSAGE FOR USS GETTYSBURG (CG 64).

9-57. What is the true bearing of Gettysburg from Vicksburg?

1. 050°
2. 070°
3. 210°
4. 230°

9-58. What is the relative bearing of Gettysburg from Vicksburg?

1. 000°
2. 180°
3. 210°
4. 230°

9-59. You are stationed on your signal bridge as a spotter. What is your main responsibility?

1. To assist in hoisting signals
2. To determine the meaning of tactical signals
3. To identify and call out each flag in a received signal
4. To record incoming signals

9-60. You are the spotter on your signal bridge. The ship maneuvers in such a way that you have difficulty reading the flaghoist signal. What problem?

1. Inform the leading Signalman
2. Inform the commanding officer
3. Have another Signalman assist you from a different position
4. Move to another position

9-61. Time of transmission, reference number, and date-time group of a sending station are noted on a received message by what individual?

1. Recorder
2. Spotter
3. Signalman of the watch
4. Signalman supervisor

9-62. At the time of receipt of a visual message, the message is initialed by the recorder and supervisor.

1. True
2. False

9-63. How many minutes does it take for a lookout to obtain the best night vision after leaving a light compartment?

1. 10 min
2. 20 min
3. 30 min
4. 40 min

9-64. A lookout may use which of the following terms when reporting contacts to the bridge?

1. Relative bearing
2. True bearing
3. Position angle
4. All of the above

9-65. The Signalman should be the first to sight and identify objects, even on ships with an assigned lookout team.

1. True
2. False

9-66. What publication requires that an accurate and complete record be maintained of all events that occur during each watch?

1. ACP 121
2. ACP 129
3. NTP 3
4. NTP 4

9-67. Before assigning any classification to the visual log, you should consult what instruction?

1. SECNAVINST 5212.5
2. OPNAVINST 5510.1
3. OPNAVINST 4790.4
4. OPNAVINST 3120.32

- 9-68. The visual log should be retained for a minimum of how many months before disposal?
1. 1
 2. 6
 3. 12
 4. 18
- 9-69. Which of the following information is NOT recorded in the visual log?
1. A time zone change
 2. A broken searchlight
 3. A exchange of calls
 4. The conducting of flight ops
- 9-70. What is the transmission abbreviation for an infrared non-directional message?
1. NFL
 2. NBK
 3. MPL
 4. NIL
- 9-71. Even though traffic is not transmitted to an exempted addressee, the addressee should still be logged.
1. True
 2. False
- 9-72. What kind of time is used for entries in the visual log, and how often is a new page started?
1. GMT, each watch
 2. Local, each watch
 3. GMT, daily
 4. Local, daily
- 9-73. How should you correct an error in the visual log?
1. Erase the entry and rewrite it correctly
 2. Draw a single line through the entry, reenter it correctly, and have the leading Signalman initial the change
 3. Draw a single line through the entry, reenter it correctly, and initial the change
 4. Draw a single line through the entry and reenter it correctly
- 9-74. As a general rule, how often should the leading Signalman check the visual log?
1. Daily
 2. Weekly
 3. Monthly
 4. Quarterly

ASSIGNMENT 10

Textbook Assignment: "Watchstanding Duties" (continued) and "Navigational Duties," chapters 8 and 9, pages 8-6 through 9-5.

- 10-1. Your ship is the OTC for flaghoist drill. You hoist the signal to indicate the start of the drill. Where should you log this signal?
1. Communications drill log
 2. Visual communications log
 3. Deck log
 4. Communications center log
- 10-2. In what order are messages filed in the visual station file?
1. By classification
 2. By alphabetical order
 3. By date-time group
 4. By priority
- 10-3. What is the minimum retention period for the visual station file?
1. 10 days
 2. 20 days
 3. 30 days
 4. 40 days
- 10-4. What file contains a copy of every message sent or received by your ship?
1. Visual station
 2. General message
 3. Communications center master
 4. Cryptocenter
- 10-5. Who has custody of publications issued to the signal bridge?
1. Communications officer
 2. Signal supervisor
 3. Leading Signalman
 4. Signal officer
- 10-6. At what time should you conduct your watch-to-watch inventory?
1. At any time during the watch
 2. At the change of each watch
 3. Within 15 minutes after relieving the watch
 4. Within 15 minutes after being relieved from your watch
- 10-7. Normally, the watch-to-watch inventory must be retained for at least how many days?
1. 10 days
 2. 20 days
 3. 30 days
 4. 40 days
- 10-8. Classified material is made available to personnel only on a need-to-know basis.
1. True
 2. False
- 10-9. Who is directly responsible for classified material held on the signal bridge?
1. The signal supervisor
 2. The signal officer
 3. The communications officer
 4. The commanding officer
- 10-10. If there are proper stowing facilities on the signal bridge, who is responsible for delivering, collecting, and securing classified material?
1. The commanding officer
 2. The signal officer
 3. The signal supervisor
 4. The watch supervisor

QUESTIONS 10-11 THROUGH 10-21 PERTAIN TO EMERGENCY SIGNALS.

- 10-11. What signal should a pilot fire to indicate that an early landing is necessary in the interest of safety, but he/she can orbit a bit longer?
1. One red flare
 2. Two red flares
 3. One green flare
 4. Two green flares
- 10-12. If his/her plane is equipped for visual signaling, what should a pilot signal to indicate receipt of a message?
1. B
 2. C
 3. O
 4. R
- 10-13. What should a helicopter pilot fire to indicate the need for an immediate landing?
1. A white flare
 2. A red flare
 3. A green flare
 4. A yellow flare
- 10-14. During wartime, your ship receives a signal at 1100 from an aircraft that indicates the need for an emergency landing. What signal should your ship use to indicate that the ship is ready to receive the aircraft for immediate landing?
1. A series of red flares
 2. A series of white flares
 3. A series of green flares
 4. Flashing Z 's
- 10-15. To indicate to a pilot NOT to land, ditch, or bail out in the area close to the ship, what signal should you flash?
1. C
 2. F
 3. Y
 4. Z
- 10-16. What signal should your ship hoist to indicate to all ships in the area that a fixed wing emergency landing is in progress and to keep clear?
1. EMERGENCY GOLF
 2. EMERGENCY FOXTROT
 3. EMERGENCY SIX
 4. EMERGENCY HOTEL
- 10-17. What special signal should you flash to indicate that the OTC has given permission for an aircraft in distress to approach your ship?
1. A white G
 2. A green G
 3. A red G
 4. A white R
- 10-18. A submarine fires a white or yellow smoke bomb followed by a second white or yellow smoke bomb 3 minutes later. What does this signal mean?
1. Coming to the surface
 2. Coming to periscope depth
 3. Submerging to periscope depth
 4. Submerging completely
- 10-19. What signal should a submarine fire to indicate that she is carrying out emergency surfacing procedures?
1. A white smoke bomb
 2. A green smoke bomb
 3. A red smoke bomb
 4. A white and green smoke bomb
- 10-20. Where should you always hoist OSCAR for a man overboard emergency?
1. At the gaff
 2. At the mizzen truck
 3. At the main mast
 4. Where best seen

- 10-21. Which of the following signals does NOT indicate a man overboard at night?
1. Six blasts on the ship's whistle
 2. Flashing the not-under-command lights
 3. A white pyrotechnic signal
 4. A red pyrotechnic signal

QUESTIONS 10-22 THROUGH 10-43 PERTAIN TO THE DUTIES OF A BOATCREW SIGNALMAN.

- 10-22. What is the primary reason for assigning a Signalman to a boatcrew?
1. To help retrieve a person overboard
 2. To act as an extra lookout
 3. To pass steering directions received from the ship to the coxswain
 4. To inform nearby ships of a person overboard
- 10-23. When fired from a Mk 135 signal illumination kit, a flare will rise to what minimum height?
1. 150 ft
 2. 250 ft
 3. 350 ft
 4. 450 ft
- 10-24. What is the minimum number of seconds a Mk 135 flare will burn?
1. 3.5
 2. 4.5
 3. 5.5
 4. 6.5
- 10-25. If the Mk 135 flare fails to fire, try again and then discard overboard.
1. True
 2. False

IN ANSWERING QUESTIONS 10-26 THROUGH 10-28, SELECT FROM COLUMN B THE COLOR OF THE FLARE MATCHING THE SIGNAL IN COLUMN A.

<u>A. SIGNAL</u>	<u>B. COLOR</u>
10-26. Need assistance	1. Green
10-27. Cannot find person	2. White
10-28. Have recovered person	3. Red

-
- 10-29. You are the Signalman in a boat searching for a person washed overboard. The ship fires two green stars. What is the meaning of this signal?
1. Steer to starboard
 2. Steer straight toward the ship
 3. Steer straight away from the ship
 4. Return to the ship
- 10-30. You are the boatcrew Signalman. Your ship fires two white stars. What should you direct the coxswain to do?
1. Return to the ship
 2. Steer straight away from the ship
 3. Steer to port
 4. Hold steady on present course
- 10-31. What signal should your ship use to direct your boat to return to the ship?
1. One red star
 2. Two red stars
 3. One green star
 4. Two green stars

IN ANSWERING QUESTIONS 10-32 THROUGH 10-35, SELECT FROM COLUMN B THE HOIST YOU SHOULD EXECUTE WHEN GIVEN THE ORDER IN COLUMN A.

<u>A. ORDER</u>	<u>B. HOIST</u>
10-32. Steer right	1. EIGHT
10-33. Steer straight toward the ship	2. QUEBEC
10-34. Steer straight away from the ship	3. EIGHT STBD
10-35. Return to ship	4. EIGHT SCREEN

10-36. While on watch, your most likely method of sending administrative traffic is by what means?

1. Flashing light and semaphore
2. Flashing light and flaghoist
3. Semaphore and flaghoist
4. Semaphore and pyrotechnics

IN ANSWERING QUESTIONS 10-37 THROUGH 10-41, SELECT FROM COLUMN B THE WEATHER WARNING THAT IS INDICATED BY THE SIGNAL IN COLUMN A. (PENNANTS ARE RED; FLAGS ARE RED WITH A BLACK SQUARE CENTER).

<u>A. SIGNAL</u>	<u>B. WARNING</u>
10-37. One pennant	1. Small craft
10-38. One flag	2. Storm
10-39. Three lights	3. Gale
10-40. Two flags	4. Hurricane
10-41. One white light over one red light	

10-42. Storm warning signals may be used to inform international vessels of a hurricane storm.

1. True
2. False

QUESTIONS 10-43 THROUGH 10-47 PERTAIN TO UNDERWAY REPLENISHMENT.

10-43. The control ship is the ship that maintains course and speed and normally serves as the guide.

1. True
2. False

10-44. What signal should you hoist to indicate to the delivery ship that you are ready to come alongside?

1. ROMEO closed up
2. ROMEO at the dip
3. ROMEO hauled down
4. PREP closed up

10-45. What signal should you hoist to indicate that you have to temporarily stop supplying ammo?

1. PREP closed up
2. BRAVO closed up
3. BRAVO at the dip
4. ROMEO closed up

10-46. What dayshape signal should you display when you are alongside another ship?

1. BALL-BALL
2. BALL-DIAMOND
3. DIAMOND-BALL-DIAMOND
4. BALL-DIAMOND-BALL

10-47. Along with the flaghoist signal for emergency breakaway, the initiating ship will sound six short blasts on the ship's whistle.

1. True
2. False

QUESTIONS 10-53 THROUGH 10-75 PERTAIN TO NAVIGATIONAL DUTIES.

10-53. What is the directive force of a magnetic compass?

1. The magnetic field of the North Pole
2. The magnetic force of the South Pole
3. The magnetic field of Earth
4. The sum of the differences between Earth's two magnetic fields

10-54. How are shipboard magnetic compasses classified?

1. Location in the ship
2. Degree of magnetic protection
3. Accuracy
4. Use

10-55. What compass does the navigator use to determine the accuracy of other compasses?

1. Steering compass
2. Standard compass
3. Gyrocompass
4. Any compass he/she believes to be the most accurate

10-56. Where is the steering compass located?

1. After steering
2. Secondary conn
3. Near the helmsman
4. Bridge wing

IN ANSWERING QUESTIONS 10-48 THROUGH 10-51, SELECT FROM COLUMN B THE COMMODITY THAT FITS THE SIGNAL LISTED IN COLUMN A.

A. SIGNAL

B. COMMODITY

10-48. Green

1. Stores

10-49. Blue

2. Ammunition

10-50. White

3. Diesel oil

10-51. Green with vertical white stripes

4. Water

10-52. What is the color of the distance marker used to indicate 180 feet?

1. Red
2. Blue
3. White
4. Green

COURSES AND BEARINGS, WHEN RECORDED, ARE CHARACTERIZED ACCORDING TO THE TYPE OF COMPASS USED. IN ANSWERING QUESTIONS 10-57 THROUGH 10-60, SELECT FROM COLUMN B THE PROPER METHOD OF RECORDING A BEARING WHEN UTILIZING THE COMPASS IN COLUMN A.

A. COMPASS

B. DESIGNATION

- | | |
|---|----------|
| 10-57. Standard | 1. PSTCO |
| 10-58. Steering | 2. PSC |
| 10-59. Gyro | 3. PGC |
| 10-60. That which points to true rather than magnetic north | |

-
- 10-61. The basis of determining all true bearings and courses is true north. This being so, why don't navigators use the compass that always points to true north as the ship's standard of compass accuracy?
1. It is affected by magnetic variation
 2. Others are unaffected by magnetic deviation
 3. It is subject to mechanical and electrical failure
 4. Others are never subject to failure

- 10-62. What term denotes the nonmagnetic metal ring that is equipped with a sighting device and titts over a gyro repeater or a magnetic compass?
1. Bearing circle
 2. Azimuth circle
 3. Telescopic alidade
 4. Vane circle

- 10-63. From your ship's position you can see (A) Venus and (B) Cape Henry Light. In what way should you report their direction?

1. Azimuth of (A), bearing of (B)
2. Azimuth of both (A) and (B)
3. Bearing of (A), azimuth of (B)
4. Bearing of (A) and (B)

- 10-64. When taking a bearing of a lighthouse, what should you train on that lighthouse?

1. Prism
2. Vane
3. Hairline
4. Reflector

- 10-65. How is the bearing of an object indicated on a bearing or azimuth circle?

1. By the hairline in the reflecting prism of the after vane
2. By the hairline in the reflecting prism of the forward vane
3. By the vertical wire in the near vane
4. By the vertical wire in the far vane

- 10-66. When taking an azimuth of the sun, you should train the azimuth circle so that the sunlight is reflected from the concave mirror into what part?

1. The peep vane
2. The far vane
3. The prism
4. The mirror behind the far vane

- 10-67. When measuring the azimuth of a dimly shining star, you should train the azimuth circle so that the star's position is in what position?

1. In the concave mirror
2. In the prism attachment
3. Under the hairline of the prism attachment
4. Under the hairline in the far vane prism

- 10-68. You can determine a relative bearing with an azimuth circle by training the sighting vanes on an object and reading its bearing from what part?
1. The spirit level
 2. The prism
 3. The beam of light on the compass card
 4. The inner circle graduation adjacent to the lubber's line
- 10-69. When using a telescopic alidade, where should you take bearings directly from?
1. The sighting vanes
 2. The lubber's line
 3. The compass card
 4. The spirit level
- 10-70. What term denotes the angular position of degrees, minutes, and seconds of arc north and south of the equator?
1. Longitude
 2. Latitude
 3. Parallel
 4. Meridian
- 10-71. In giving navigational positions, one degree is divided into how many minutes?
1. 15
 2. 30
 3. 45
 4. 60
- 10-72. In nautical distance, one degree of latitude may be considered as how many nautical miles?
1. 15
 2. 30
 3. 45
 4. 60
- 10-73. What is the most commonly used navigational chart?
1. Transverse mercator
 2. Mercator projection
 3. Gnomonic
 4. Polyconic
- 10-74. Which of the following charts shows the greatest details?
1. 1:5,000
 2. 1:50,000
 3. 1:100,000
 4. 1:600,000
- 10-75. Which of the following scales is the smallest?
1. 1:5,000
 2. 1:50,000
 3. 1:100,000
 4. 1:600,000

ASSIGNMENT 11

Textbook Assignment: "Navigational Duties" (continued), chapter 9, pages 9-5 through 9-31.

IN ANSWERING QUESTIONS 11-1 THROUGH 11-5, SELECT FROM COLUMN B THE TYPE OF CHART THAT MOST LIKELY WOULD BE USED WITH THE SCALE IN COLUMN A.

A. SCALE

B. CHART

- | | |
|-----------------|------------|
| 11-1. 1:600,000 | 1. General |
| 11-2. 1:100,000 | 2. Harbor |
| 11-3. 1:80,000 | 3. Coastal |
| 11-4. 1:20,000 | |
| 11-5. 1:5,000 | |

11-6. Where on a chart should you look to find the notation that provides the key to depth information?

1. On the back
2. In the corner
3. Under the chart title
4. Above the chart title

11-7. All charts used by the U.S. Navy are issued by what organization?

1. The National Ocean Service
2. The Defence Mapping Agency
3. The U.S. Coast Guard
4. The British Admiralty

11-8. The Notice to Mariners issues information on new charts, chart corrections, cancellations, and changes to nautical charts and publications.

1. True
2. False

11-9. How often are Notice to Mariners issued to U.S. Navy ships?

1. Weekly
2. Monthly
3. Bi-monthly
4. Annually

QUESTIONS 11-10 THROUGH 11-42 PERTAIN TO AIDS TO NAVIGATION.

11-10. A visual aid to navigation has which of the following benefits?

1. Its height is shown on the area chart
2. It often can be used to fix the ship's position
3. It always indicates a danger area
4. Its light is never extinguished

11-11. Lighted aids to navigation are indicated on charts by what item?

1. Capital letters
2. Slanted letters
3. Units
4. Symbols

11-12. Which of the following descriptions of light aids is NOT contained in the *List of Lights*?

1. Lighted harbor buoys
2. Storm signals
3. Radio directions
4. Signal stations

11-13. What are the four standard colors for lights on aids to navigation?

1. Green, red, white, blue
2. Green, red, yellow, blue
3. Green, red, white, yellow
4. Green, red, yellow, orange

- 11-14. Information needed to amplify a chart's description of a light in U.S. waters can be found in what publication?
1. *List of Lights*
 2. *Light list*
 3. Portfolio Chart List
 4. Chart No. 1
- 11-15. What is the most important characteristic of a navigation light for identification purposes?
1. Fixed lights
 2. Periods of systematic change
 3. Color
 4. Size
- 11-16. What type of light flashes at least 50 times each minute?
1. Fixed
 2. Occulting
 3. Alternating
 4. Quick flashing
- 11-17. What type of light shows groups of two or more flashes at regular intervals?
1. Isophase
 2. Morse code
 3. Group flashing
 4. Occulting
- 11-18. What range is the maximum distance at which a light can be seen under the existing visibility condition?
1. Luminous
 2. Geographic
 3. Computed
 4. Nominal
- 11-19. What range is the maximum distance at which a light can be seen in clear weather?
1. Luminous
 2. Geographic
 3. Computed
 4. Nominal
- 11-20. In addition to the light itself, a lighthouse may contain which of the following aids?
1. Radar and fog signaling equipment
 2. Radar reflectors and direction-finding instruments
 3. Fog signaling and radio beacon equipment
 4. Radio beacon equipment and radar reflectors
- 11-21. Where conditions make it impossible or impractical to build a permanent lighthouse, what aid(s) is/are used?
1. Buoys
 2. Channel markers
 3. Light station
 4. Lightship
- 11-22. When a regular lightship goes in for repair, what is painted on the side of the ship taking her place?
1. RELIEF
 2. RELIEF SHIP
 3. SHIP
 4. POSITION
- 11-23. What term denotes the red glass placed in the lanterns of certain lighthouses to indicate danger bearing?
1. Light areas
 2. Sector light
 3. Sections light
 4. Set light
- 11-24. Although buoys are valuable aids to navigation, they must never be relied on exclusively.
1. True
 2. False
- 11-25. What IALA Maritime Buoyage System region should you be using if you were located in Africa?
1. A
 2. B
 3. C
 4. D

- 11-26. The major rule to remember when you use the different IALA regions is the color of the lateral marks.
1. True
 2. False
- 11-27. What marks are used to indicate that navigable waters lie to the named side of the mark?
1. Lateral
 2. Cardinal
 3. Isolated
 4. Safe water
- 11-28. What marks are used to call attention to an area or specific feature?
1. Lateral
 2. Cardinal
 3. Special
 4. Isolated
- 11-29. What are the shapes of can and nun buoys, respectively?
1. Conical and cylindrical
 2. Cylindrical and conical
 3. Straight-sided and narrow-waisted
 4. Narrow-waisted and straight-sided
- 11-10. Lighted buoys in the United States are referred to as what type of buoys?
1. Can
 2. Nun
 3. Pillar
 4. Light
- 11-31. What color buoy is used to mark obstructions and channel junctions?
1. Red and green
 2. Red and black
 3. Green and black
 4. Green and yellow
- 11-32. What is the meaning of a channel junction buoy, if the top band of the buoy is green?
1. Preferred channel is to starboard
 2. Preferred channel is to port
 3. Do not pass to starboard
 4. Do not pass to port
- 11-33. What color buoys are used to indicate the mid-channel, a fairway, or a landfall?
1. Yellow
 2. Red and green
 3. Red and white
 4. Red and black
- 11-34. What color buoys are used to mark anchorage sights?
1. Yellow
 2. Red and green
 3. Red and white
 4. Red and black
- 11-35. When numbering buoys, you should use odd numbers only on solid red buoys.
1. True
 2. False
- 11-36. What is the color of the triangular daymark that has the approximate shape of the top of a nun buoy?
1. Red
 2. Green
 3. Black
 4. Yellow
- 11-37. You are under way from port and you see a cardinal mark that is very quick flashing every 5 seconds. What direction should you travel?
1. North
 2. East
 3. South
 4. West

- 11-38. What mark is used to indicate either a shoal that is well offshore or an inlet separated by a narrow channel?
1. Isolated
 2. Safe water
 3. Special
 4. Cardinal
- 11-39. Every buoy or light structure along the Intracoastal Waterway has part of its surface painted what color?
1. Red
 2. Black
 3. Green
 4. Yellow
- 11-40. When a ship reaches a position where the two range lights or beacons are seen exactly in line, that ship is
1. off range
 2. on range
 3. guiding correctly
 4. not guiding correctly
- 11-41. By what characteristic can you identify a lighthouse that is transmitting fog signals?
1. The intensity of the blast
 2. The number, interval, and tone of the blast
 3. The code formed by the signal
 4. The distance the sound carries
- 11-42. What sound apparatus emits sound through a stell reed that is vibrated by compressed air?
1. Diaphones
 2. Diaphragm horns
 3. Reed horns
 4. Siren
- 11-43. Inland Rules apply to all vessels on the inland waters of the United States and to vessels of the United States on the Canadian waters of the Great Lakes.
1. True
 2. False
- 11-44. What is the international whistle signal for I AM ALTERING MY COURSE TO PORT?
1. One short blast
 2. Two short blasts
 3. Three short blasts
 4. One prolonged blast
- 11-45. Under both International and Inland Rules, what is the minimum number of short blasts used as the danger signal?
1. 7
 2. 6
 3. 5
 4. 4
- 11-46. What is the inland whistle signal for I INTEND TO LEAVE YOU ON MY STARBOARD SIDE?
1. One short blast
 2. One long blast
 3. Two short blasts
 4. Two long blasts
- 11-47. What rule applies when two power-driven vessels are crossing so as to involve the risk of collision?
1. 14
 2. 15
 3. 16
 4. 17
- 11-48. A sailboat always has the right-of-way over a power-driven vessel.
1. True
 2. False

QUESTIONS 11-43 THROUGH 11-65 PERTAIN TO THE RULES OF THE ROAD.

- 11-49. International Rules of the Road require that rules for lights are to be complied with from sunset to sunrise. During what periods must lights be complied with under Inland Rules?
1. 1 hour before sunset to 1 hour before sunrise
 2. 1 hour after sunset to 1 hour before sunrise
 3. 1 hour before sunset to 1 hour after sunrise
 4. Sunset to sunrise
- 11-50. The fore masthead light on a power-driven vessel is how many feet above the deck?
1. Between 10 and 15
 2. Between 15 and 30
 3. Between 20 and 40
 4. 45
- 11-51. A vessel over 50 meters in length shows a white light aft. How many feet is this light higher than the fore masthead light?
1. 10 ft
 2. 15 ft
 3. 20 ft
 4. 25 ft
- 11-52. Depending on the size of the vessel, side lights must be visible from what distance?
1. 1 to 3 miles
 2. 2 to 4 miles
 3. 3 to 6 miles
 4. 5 to 8 miles
- 11-53. What should be the arc of horizon of the side light?
1. 112.5°
 2. 115.5°
 3. 125.5°
 4. 135.5°
- 11-54. What should be the arc of horizon of the stern light?
1. 100°
 2. 115°
 3. 125°
 4. 135°
- 11-55. What light signal indicates a pilot vessel?
1. White over white
 2. White over red
 3. Red over white
 4. Red over red
- 11-56. What is the daylight display for a ship anchored in a channel?
1. A diamond shape forward
 2. A diamond shape aft
 3. A ball shape forward
 4. A ball shape aft
- 11-57. A power-driven vessel greater than 50 meters is towing astern, with the length of tow less than 200 meters. What light should it display?
1. Two masthead lights, side lights, and a white stern light
 2. Three masthead lights, side lights, and a yellow stern light
 3. Two masthead lights, an after masthead light, side lights, and a yellow-over-white stern light
 4. Two masthead lights, side lights, and a yellow-over-white stern light
- 11-58. What is the daytime signal for a towing vessel restricted in her movement?
1. BALL-DIAMOND-BALL
 2. DIAMOND-BALL-DIAMOND
 3. BALL-DIAMOND-BALL and a DIAMOND
 4. DIAMOND-BALL-DIAMOND and a BALL
- 11-59. You sight a ship showing only its side lights and two vertically aligned all-around red lights. What condition of the ship should you report to the bridge?
1. It has run aground
 2. It is towing another vessel
 3. It is moored in the channel
 4. It is not under command but making way

- 11-60. What is the inland light signal for a ship pushing ahead or alongside a vessel?
1. Two masthead lights, side lights, and a stern light
 2. Two masthead lights, side lights, and a yellow-over-yellow stern light
 3. Two masthead lights, side lights, and a white-over-yellow stern light
 4. Two masthead lights, side lights, and a yellow-over-white stern light
- 11-61. What is the daytime signal for a vessel constrained by draft?
1. BALL
 2. DIAMOND
 3. CYLINDER
 4. BALL-BALL-BALL
- 11-62. What is the duration of a prolonged blast?
1. 2 to 4 sec
 2. 3 to 5 sec
 3. 4 to 6 sec
 4. 6 to 8 sec
- 11-63. What is the fog signal for a vessel over 100 meters in length, anchored in fog?
1. Rapid ringing of the gong for 5 seconds
 2. Five strokes of the bell
 3. Rapid ringing of the bell for 5 seconds
 4. Rapid ringing of the bell and gong for 5 seconds
- 11-64. What is the fog signal for a pilot vessel on duty?
1. One prolonged blast
 2. Two prolonged blasts
 3. Three short blasts
 4. Four short blasts
- 11-65. What is the fog signal for a power-driven vessel making headway in thick weather?
1. One prolonged blast
 2. Two prolonged blasts
 3. One prolonged blast followed by one short blast
 4. One prolonged blast followed by two short blasts

ASSIGNMENT 12

Textbook Assignment: "Honors and Ceremonies," chapter 10, pages 10-1 through 10-21.

- | | |
|--|--|
| <p>12-1. How should the national flag be displayed when displayed with another flag against a wall from crossed staffs?</p> <ol style="list-style-type: none"> 1. From your right as you face it 2. From the flag's own right 3. From your left with your back to it 4. From the flag's own left <p>12-2. Before the national flag is half-masted, it must be first hoisted to the peak.</p> <ol style="list-style-type: none"> 1. True 2. False <p>12-3. Where should the ensign be displayed while your ship is at anchor?</p> <ol style="list-style-type: none"> 1. Gaff 2. Main truck 3. Jackstaff 4. Flagstaff <p>12-4. During what period is the ensign displayed while your ship is in port?</p> <ol style="list-style-type: none"> 1. Sunrise to 1800 2. Sunrise to sunset 3. 0800 to sunset 4. 0800 to 1800 <p>12-5. To what point of hoist is the ensign shifted when your ship gets under way?</p> <ol style="list-style-type: none"> 1. Gaff 2. Jackstaff 3. Main truck 4. Flagstaff <p>12-6. What is the flagstaff length for a vessel 225 feet in length?</p> <ol style="list-style-type: none"> 1. 12 ft 2. 16 ft 3. 17 ft 4. 20 ft | <p>12-7. In a semicircle grouping, where is the U.S. ensign displayed?</p> <ol style="list-style-type: none"> 1. The first flag starting from the right 2. The first flag starting from the left 3. In the middle of the semicircle 4. In alphabetical order <p>12-8. When half-masting during dress or full-dress ship, all national ensigns displayed should be half-masted.</p> <ol style="list-style-type: none"> 1. True 2. False <p>12-9. During what time period is the ensign half-masted on Memorial Day?</p> <ol style="list-style-type: none"> 1. Dawn to dusk 2. Sunrise to sunset 3. 0800 to sunset 4. 0800 to 1220 |
|--|--|

IN ANSWERING QUESTIONS 12-10 THROUGH 12-13, SELECT FROM COLUMN B THE PERIOD OF TIME DURING WHICH THE NATIONAL FLAG IS HALF-MASTED ON THE OCCASION OF THE DEATH OF THE CIVIL OFFICIAL IN COLUMN A.

	<u>A. OFFICIAL</u>	<u>B. PERIOD</u>
12-10. Vice President		1. 10 days
12-11. President		2. 30 days
12-12. Former President		3. Day of death until burial
12-13. Secretary of the Navy		

- 12-14. What is the correct way to half-mast the ensign at morning colors and haul it down at evening colors (M-morning; E-evening)?
1. M-raise to half-mast and secure; E-lower directly from half-mast
 2. M-raise to half-mast and secure; E-raise to peak, then lower
 3. M-raise to peak, then lower to half-mast; E-raise to peak, then lower
 4. M-raise to peak, then lower to half-mast; E-lower directly from half-mast
- 12-15. When, if ever, should a U.S. Navy ship originate a salute to another ship by dipping its ensign?
1. When the ship is under the command of a non-NATO ally
 2. When the ship is of a NATO ally
 3. When the ship is commanded by a senior officer
 4. Never
- 12-16. While on the high seas, you pass a merchant vessel that dips its ensign. You should not answer the dip if it is flying the flag of a nation that the United States considers to be of what origin?
1. Friendly
 2. Unfriendly
 3. Recognized
 4. Unrecognized
- 12-17. A merchant ship dips its flag in salute to your ship at 0715 while you are in port. How should you respond?
1. Hoist the ensign for a brief time, then haul it down
 2. Hoist the ensign, return the dip, and haul the ensign down
 3. Return the dip after morning colors
 4. Do nothing
- 12-18. Your ship is flying a size 8 national ensign. What size union jack should you be flying?
1. 5
 2. 7
 3. 8
 4. One the same size as the union of the ensign
- 12-19. The union jack flying from the yardarm of a naval vessel has what meaning?
1. A court of inquiry is in session
 2. Funeral service for the commanding officer is in session
 3. Civilian official is departing in 5 minutes
 4. An official visit from a diplomat
- 12-20. When embarked in a U.S. Navy boat within the waters of the country to which he/she is accredited, a Charge d’Affaires of the United States should display what from the bow of the boat?
1. U.S. Navy flag
 2. Union jack
 3. National ensign
 4. Miniature of his/her personal flag
- 12-21. What type of commissioned ship should NOT display a commission pennant, command pennant, or personal flag?
1. Destroyer
 2. Cruiser
 3. Tug
 4. Hospital ship
- 12-22. What pennant or flag may replace the commission pennant?
1. Church pennant
 2. Personal flag
 3. Foreign ensign when in a foreign port
 4. Union jack during a general court martial
- 12-23. It is permissible to display a command pennant and a commission pennant simultaneously.
1. True
 2. False

12-24. Flag officers afloat fly their personal flag during what periods?

1. From 0800 until evening colors
2. From sunrise to sunset
3. From sunset to sunrise
4. Continuously

12-25. When two commanders within a type are entitled to display the same command pennant and have the same organizational number, the senior of the two uses roman numerals on the pennant.

1. True
2. False

IN ANSWERING QUESTIONS 12-26 AND 12-27, ASSUME THAT YOU ARE A PART OF THE FLAGSHIP SIGNAL GANG. THE SHIP IS TO BE DRESSED AT MORNING COLORS. YOU WILL BE RESPONSIBLE FOR SHIFTING THE COMMANDER'S PERSONAL FLAG.

12-26. If your ship is two-masted, what should be your point of hoist?

1. Main truck
2. Fore truck
3. Starboard main yardarm
4. Port main yardarm

12-27. If your ship has only one mast, where should the flag be displayed?

1. Main truck
2. Starboard yardarm
3. Port yardarm
4. Fore truck

12-28. While riding in an automobile, when may an officer entitled to a personal flag or command pennant display his/her personal flag or pennant?

1. During national holidays only
2. Any time after becoming entitled to the flag or pennant
3. Whenever he/she believes it is necessary
4. On official occasions only

12-29. What is the staff ornament for vehicle flags?

1. Acorn
2. Ball
3. Flat truck
4. Star

12-30. Upon the death of the commanding officer, the commission pennant, along with the ensign and union jack, is half-masted from the death to sunset of the

1. day of the funeral
2. second day after the funeral
3. 10th day after the funeral
4. 30th day after the funeral

12-31. Aboard a mastless ship, where is the commission pennant flown?

1. Jackstaff
2. Flagstaff
3. Gaff
4. Highest conspicuous point

12-32. What is the major difference between a full-dressed and a dressed ship?

1. A dressed ship displays smaller ensigns than a full-dressed ship
2. A dressed ship displays a rainbow of signal flags; a full-dressed ship does not
3. A full-dressed ship displays more ensigns than a dressed ship
4. A full-dressed ship displays a rainbow of signal flags; a dressed ship does not

12-33. Ships are dressed and the ensign is hauled down from the masthead at what time and on what occasion?

1. Simultaneously with morning and evening colors
2. At 0800 and when getting under way
3. At 0800 and at sunrise
4. At 0800 and on official visits

- 12-34. One naval ship is dressed in honor of a foreign nation and another is dressed for a national holiday. What is the principal difference?
1. The ship dressed for the national holiday has a rainbow of signal flags
 2. The ship dressed in honor of a foreign nation has a rainbow of colors
 3. The ship dressed for the national holiday does not fly an ensign at the mainmast
 4. The ship dressed in honor of a foreign nation flies the ensign of that nation from the mainmast

- 12-35. When required, which ensigns should you half-mast during full-dress ship?
1. All those displayed
 2. Those displayed from the mastheads
 3. Only the one displayed at the main masthead
 4. Only the one displayed at the flagstaff

- 12-36. At what time should you hoist PREP for morning colors?
1. 0740
 2. 0745
 3. 0750
 4. 0755

- 12-37. What does a single blast from a whistle during the colors ceremonies indicate?
1. CARRY ON
 2. ATTENTION
 3. COLORS WILL BE EXECUTED IN 5 MINUTES
 4. COLORS HAS BEEN EXECUTED

- 12-38. A flag officer making an official visit is embarked in a boat displaying the ensign aft. What flag is displayed in the bow?
1. Union jack
 2. Commission pennant
 3. Personal flag
 4. Miniature flag

- 12-39. A flag officer making an unofficial visit is embarked in a boat displaying an ensign aft. What flag is displayed near the coxswain?
1. Union jack
 2. Commission pennant
 3. Personal flag
 4. Miniature flag

- 12-40. What bow marking indicates the commanding officer is on board?
1. Arrow
 2. Acorn
 3. Miniature flag
 4. Stars corresponding to rank

IN ANSWERING QUESTIONS 12-41 THROUGH 12-44, SELECT FROM COLUMN B THE APPROPRIATE BOAT HAIL FOR THE INDIVIDUAL LISTED IN COLUMN A.

	<u>A. OFFICIAL</u>	<u>B. BOAT HAIL</u>
12-41. Vice President		1. NAVAL OPERATIONS
12-42. Enlisted		2. NO, NO
12-43. Warrant officer		3. UNITED STATES
12-44. CNO		4. HELLO

-
- 12-45. A boat passing your ship is carrying a vice admiral on an official visit. The ensign on the stern is topped with a halberd. What will be the flagstaff topping for the personal flag on the bow?

1. Star
2. Spearhead
3. Battle ax
4. Halberd

- 12-46. Honors will not be rendered between U. S. Naval vessels and vessels of the U. S. Coast Guard.

1. True
2. False

12-47. You are overtaking a Navy ship that is not flying a distinctive mark. To determine who will initiate passing honors, you should use what publication?

1. NTP 4
2. NTP 13
3. DNC
4. The fleet lineal list

12-48. A boat showing the personal flag of a naval officer nears your ship. You should sound attention when the boat comes within how many yards of your ship?

1. 400
2. 600
3. 800
4. 900

12-49. Assuming your commanding officer is junior, when should you sound ATTENTION when meeting another ship heading in the opposite direction?

1. When the bow of your ship is abreast the bridge of the other ship
2. When the bow of your ship passes the bow of the other ship
3. When the bridge of your ship is abreast the bridge of the other ship
4. When the bow of your ship is 400 yards from the bow of the other ship

12-50. You sound one blast on the whistle to signify ATTENTION TO STARBOARD. How many blasts should you sound to terminate the hand salute?

1. One
2. Two
3. Three
4. Four

12-51. Manning the rails is part of the passing honors rendered to which of the following officials?

1. President only
2. President and Vice President only
3. President and Secretary of State only
4. President, Vice President, and Secretary of State

12-52. When the Secretary of the Navy is in a passing boat rather than a passing ship, how do passing honors differ?

1. The Admiral's March is played instead of the National Anthem
2. The band plays ruffles and flourishes
3. The crew musters at quarters
4. Only the officer of the deck salutes

12-53. Passing honors may be rendered after sunset when international courtesy requires such action.

1. True
2. False

12-54. Side honors are normally dispensed with on which of the following occasions?

1. The crew is at mess
2. Command is being changed
3. A scheduled visit from an inspection team
4. A civil officer begins an official visit to the ship

QUESTIONS 12-55 THROUGH 12-58 PERTAIN TO HONORS FOR OFFICIAL VISITS.

12-55. When should you break the dignitary's flag when honors include a gun salute?

1. When his/her boat or vehicle has been sighted
2. When his/her boat or vehicle comes alongside
3. On the last gun
4. On the first gun

12-56. When should the piping of the side begin?

1. When the dignitary's boat or vehicle is sighted
2. When the dignitary's boat or vehicle comes alongside
3. On the last gun of the gun salute
4. On the first gun of the gun salute

12-57. When a dignitary is departing and if a gun salute is to be fired, when should you haul down the dignitary flag?

1. As the dignitary arrives on the quarterdeck
2. At the start of the call
3. At the first gun
4. At the last gun

12-58. What action should you take with regard to the commission pennant when the flag of a civilian official is hoisted during a visit?

1. Haul it down
2. Shift it to the fore truck
3. Shift it to the after truck
4. Shift it to the starboard yardarm

IN ANSWERING QUESTIONS 12-59 AND 12-60, REFER TO THE FOLLOWING INFORMATION: ADMIRAL SEAMAN IS RELIEVING ADMIRAL BOAT OF COMMAND OF THE SIXTH FLEET.

12-59. As the Signalman in charge of rendering honors for the occasion, when should you break Admiral Seaman's flag?

1. Immediately after Admiral Seaman reads his orders to the officers and crew
2. Immediately after the gun salute for Admiral Boat is fired
3. Immediately after Admiral Boat reads his orders to the officers and crew
4. Immediately after Admiral Boat's flag is hauled down

12-60. When should you haul down Admiral Boat's flag?

1. After Admiral Seaman reads his orders to the officer and crew
2. After the gun salute for Admiral Boat is fired
3. After the piping of the side for Admiral Seaman
4. After the piping of the side for Admiral Boat

12-61. When a foreign official visits a U.S. Navy ship and he/she is entitled to a gun salute of less than 21 guns, where should the national ensign of his/her country be flown?

1. Main masthead
2. Foremast
3. Starboard yardarm
4. Port yardarm

12-62. During a United Nations peace keeping mission to France, the U.N. flag should be flown according to rules governing display of the national flag of what country or countries?

1. United States only
2. France only
3. United States and France
4. France and the country with which she is at odds

12-63. During what period is the United Nations flag ordinarily displayed at offices occupied by the United Nations?

1. 0800 to 1800
2. 0800 to sunset
3. Sunrise to 1800
4. Sunrise to sunset

12-64. A ship may NOT display a homeward-bound pennant unless it has been on an overseas tour for a period of how many months?

1. 9 months
2. 6 months
3. 3 months
4. 12 months

QUESTIONS 12-65 AND 12-66, PERTAIN TO THE FOLLOWING INFORMATION: YOU HAVE BEEN TOLD TO MAKE UP A HOMEWARD-BOUND PENNANT BASED ON THE FOLLOWING DATA:

- A. Length of tour—34 months
- B. Number of officers that served on board for more than 9 months—20
- C. Number of enlisted that served on board for more than 9 months—145
- D. Length of ship—526 feet

12-65. How many stars should you sew into the pennant?

1. One
2. Two
3. Three
4. Five

12-66. How long should you make a homeward-bound pennant?

1. 24 ft
2. 145 ft
3. 165 ft
4. 526 ft

12-67. If both the Red Cross flag and the national flag are hoisted on the same staff ashore, where should the Red Cross flag be displayed in relation to the national flag?

1. On the same halyard, above the national flag
2. On the same halyard, below the national flag
3. On the same halyard, at the same level as the national flag
4. On a separate halyard

12-68. Aboard ship, what flag may be flown above the ensign?

1. Red Cross flag
2. Church pennant
3. Union jack
4. United Nations flag

IN ANSWERING QUESTIONS 12-69 AND 12-70, ASSUME THAT THE FLAGSTAFF ABOARD YOUR SHIP IS FITTED WITH TWO HALYARDS.

12-69. If the ensign is at half-mast, to what position must the church pennant be hoisted?

1. Parallel with and to the right of the ensign
2. Parallel with and to the left of the ensign
3. Just below the ensign
4. Just above the ensign

12-70. Where should your ship display the POW/MIA flag during Veterans day?

1. Outboard port yardarm
2. Outboard starboard yardarm
3. Inboard port yardarm
4. Inboard starboard yardarm

12-71. When displaying more than one award pennant, in what order should you hoist them?

1. At the commanding officer's discretion
2. In the order received
3. By seniority
4. Alphabetically

IN ANSWERING QUESTIONS 12-72 THROUGH 12-75, SELECT FROM COLUMN B THE SUBSTITUTE THAT INDICATES THAT THE INDIVIDUAL IN COLUMN A IS NOT ABOARD SHIP.

A. INDIVIDUAL

B. SUBSTITUTE

12-72. Commanding officer

1. FIRST

12-73. Civil official

2. SECOND

12-74. Unit commander

3. THIRD

12-75. Chief of staff

4. FOURTH

ASSIGNMENT 13

Textbook Assignment: "Security," "Amphibious Duties," and "Aircraft and Ship Identification"; chapters 11, 12, and 13; pages 11-1 through 13-25.

-
- 13-1. Within a command, who is the main advisor on information and personnel security?
1. Executive officer
 2. Commanding officer
 3. Top Secret control officer
 4. Security manager
- 13-2. What instruction should you use to find the duties of the security manager?
1. OPNAVINST 1500.1
 2. OPNAVINST 4790.4
 3. OPNAVINST 5510.1
 4. SECNAVINST 5212.5
- 13-3. Knowledge or possession of classified defense information is permitted only to persons whose official duties require access to that information (need to know).
1. True
 2. False
- 13-4. Material bearing which of the following security markings requires the least security protection?
1. Top Secret
 2. Secret
 3. Confidential
 4. Unclassified
- 13-8. Which of the following markings is NOT required for original classified material?
1. Declassification date
 2. Downgrading instructions
 3. Overall classification
 4. Date material was received
- 13-9. Where are the basic security markings found on a publication?
1. On the back page
 2. On every page
 3. On the front of the publication
 4. In the table of contents
- 13-10. Which of the following pages of a document is/are required to be marked with the overall classification?
1. Cover page
 2. Title page
 3. First page
 4. All of the above
- 13-11. The initial determination as to whether or not an individual receives a security clearance is based on a personal security investigation.
1. True
 2. False
- 13-12. What type of investigation is used to develop information as to whether the access to classified information by the person being investigated is clearly consistent with the interest of national security?
1. National Agency Check
 2. Background Investigation
 3. Special Background Investigation
 4. Personal security investigation

IN ANSWERING QUESTIONS 13-5 THROUGH 13-7, SELECT FROM COLUMN B THE CLASSIFICATION CATEGORY THAT CORRESPONDS WITH THE POSSIBLE RESULT OF COMPROMISE IN COLUMN A.

<u>A. RESULT</u>	<u>B. CATEGORY</u>
13-5. Serious damage	1. Top Secret
13-6. Grave damage	2. Secret
13-7. Identifiable damage	3. Confidential

- 13-13. An interim clearance is effective for a total of how many months, excluding the extension?
1. 5
 2. 6
 3. 7
 4. 8
- 13-14. You may store valuables, such as money and jewels, in the same container used to safeguard classified material.
1. True
 2. False
- 13-15. Aboard ship, what type of material can NOT be stored in a lock-bar cabinet?
1. Top Secret
 2. Secret
 3. Confidential
 4. Unclassified
- 13-16. Aboard ship, a strongroom with surrounding areas locked, alarmed, and access to the area patrolled by U.S. personnel, may be used to store Top Secret material.
1. True
 2. False
- 13-17. What instructions should you use to select security equipment from the National Supply Schedule?
1. OPNAVINST 4790.4
 2. OPNAVINST 5510.1
 3. SECNAVINST 5212.5
 4. SECNAVINST 10463.1
- 13-18. What form should be maintained for each security container used to store classified material?
1. OPNAV 700
 2. OPNAV 701
 3. OPNAV 5510/21
 4. OPNAV 5550/21
- 13-19. As a minimum, the combination to a security container must be changed at least how often?
1. Every 10 months
 2. Every 12 months
 3. Every 18 months
 4. Every 24 months
- 13-20. When safe combinations are selected, numbers such as birth dates and social security numbers should be used.
1. True
 2. False
- 13-21. Your vault contains Top Secret material. What should be the classification of the combination?
1. Top Secret
 2. Secret
 3. Confidential
 4. Unclassified
- 13-22. What is the standard cover sheet for a Confidential message?
1. OPNAV Form 702
 2. OPNAV Form 703
 3. OPNAV Form 704
 4. OPNAV Form 705
- 13-23. What forms should be used at the end of each working day to ensure that all classified material is stowed properly?
1. OPNAV Forms 700 and 701
 2. OPNAV Forms 701 and 702
 3. OPNAV Forms 702 and 703
 4. OPNAV Forms 703 and 704
- 13-24. The register should be retained a total of how many years after the Top Secret document has been transferred, downgraded, or destroyed?
1. 1 yr
 2. 2 yr
 3. 3 yr
 4. 5 yr

- 13-25. What form should you use to record the destruction of Top Secret material?
1. OPNAV Form 5510/12
 2. OPNAV Form 5510/21
 3. OPNAV Form 5511/12
 4. OPNAV Form 5511/21
- 13-26. Secret material will fall into what emergency-destruction priority class?
1. 1
 2. 2
 3. 3
 4. 4
- 13-27. What is the time requirement for the destruction of priority material aboard a ship?
1. 10 min
 2. 20 min
 3. 30 min
 4. 40 min
- 13-28. In at least how many fathoms of water should you be to jettison material overboard?
1. 100
 2. 500
 3. 750
 4. 1,000
- QUESTIONS 13-29 THROUGH 13-55 PERTAIN TO AMPHIBIOUS DUTIES.
- 13-29. What publication should you use for complete details on all amphibious signals and instructions?
1. ATP 1, Vol. I
 2. ATP 1, Vol. II
 3. NWP 22-3
 4. PUB 102
- 13-30. What amphibious ship embarks, transports, and lands troops and their equipment by helicopters or landing craft from other ships?
1. LCC
 2. LCAC
 3. LPH
 4. LPD
- 13-31. What amphibious ship combines many of the operational capabilities of other amphibious ships?
1. LPD
 2. LST
 3. LHA
 4. LPH
- 13-32. Where are the on-call circles located in the ship's assembly area?
1. Midship
 2. Port bow
 3. Starboard bow
 4. Astern
- 13-33. What is the lane called that extends seaward from the landing beach to the line of departure?
1. Approach lane
 2. Boat lane
 3. Control lane
 4. Assembly lane
- 13-34. What is the maximum number of debarkation stations allowed on the port side of a ship?
1. Five
 2. Six
 3. Seven
 4. Four
- 13-35. What signal should you hoist to call an LCU to station 3?
1. Flag L over white flag on the port yardarm
 2. Flag L over white flag on the starboard yardarm
 3. Flag U over white flag on the port yardarm
 4. Flag U over white flag on the starboard yardarm
- 13-36. What signal should you hoist to call two LVTs into the well deck?
1. Flag T over flag WHISKEY
 2. Flag T over flag T over flag WHISKEY
 3. Flag 2T over flag WHISKEY
 4. Flag WHISKEY over flag T

- 13-37. What individual is designated by the Commander, Amphibious Task Force for the overall coordination of the waterborne assault?
1. Primary control officer
 2. Secondary control officer
 3. Boat group commander
 4. Central control officer
- 13-38. What individual is embarked in an LCPL that is displaying the ZERO flag over the beach flag?
1. Boat group commander
 2. Boat wave commander
 3. Wave guide officer
 4. Secondary control officer
- 13-39. What individual takes station ahead of the wave and leads them to the line of departure?
1. Wave guide officer
 2. Boat group commander
 3. Boat wave commander
 4. Assistant boat group commander
- 13-40. Marker lights should be visible for at least how many yards?
1. 500
 2. 700
 3. 1,000
 4. 2,000
- 13-41. What wave light signal is used to identify the central control ship?
1. A blinking green light
 2. Two vertical blinking white lights
 3. Three vertical blinking red lights
 4. Two vertical white lights
- 13-42. What does the signal 6-4 on a boat team paddle indicate?
1. Position 6, wave 4
 2. Position 4, wave 6
 3. Wave 6, position 4
 4. Wave 4, position 6
- 13-43. What is the nighttime cargo identification signal for bulk cargo?
1. One steady green light
 2. Two steady red lights
 3. One steady red light
 4. One steady amber light
- 13-44. What signal should you hoist to indicate to wave 5 that he has a 2-minute standby?
1. Five flag closed up
 2. Five flag hauled down
 3. Five flag at the dip
 4. Five flag over blue flag
- 13-45. Boat waves proceed to battle speed at what distance from the beach?
1. 1,000 yd
 2. 2,000 yd
 3. 3,000 yd
 4. 4,000 yd
- 13-46. Grid posits are transmitted every minute from the rendezvous area. If no action is required, the grid posit should be transmitted continually until the wave is what distance from the beach?
1. 100 yd
 2. 200 yd
 3. 300 yd
 4. 400 yd
- 13-47. When the wave commander fails to receipt for orders by radio, the primary control ship will continue to transmit the orders and request visual acknowledgement.
1. True
 2. False
- 13-48. What is the normal procedure for calling wave 3 by flashing light?
1. The wave color and the number
 2. The number 3 only
 3. The boat line and the number
 4. The grid posit position and the number

- 13-49. What group should you send to order your wave to slow down?
1. RR
 2. SS
 3. TT
 4. VV

- 13-50. What signal should you send to order a boat to vector 30° to the left?
1. 3L
 2. L3
 3. VL3
 4. V3L

- 13-51. Using the information “Wave 5 grid posit is in the right portion of the boat lane 1,700 yards from the beach at time 15 and is to slow down,” what signal should you send?
1. 5GPR17T15
 2. 5GPR17T15SS
 3. 5GPR17T15TT
 4. 5GP1715TT

- 13-52. What signal is sent to the control ship upon touchdown of the first boat of each wave?
1. TD TD TD
 2. SS SS SS
 3. DDD
 4. TTT

QUESTIONS 13-53 THROUGH 13-55 PERTAIN TO QUIET LANDING PROCEDURES.

- 13-53. What group should you send to indicate to wave 4 to vector left 20° and make 6 knots?
1. 4VL26
 2. 4VLL6
 3. 4LL6
 4. LL46

- 13-54. What group should you send to indicate to wave 1 to vector left 10° and make battle speed?
1. 1VLBBB
 2. 1BBBLL
 3. 1LBBB
 4. 1L1BBB

- 13-55. The mission of the salvage organization is to keep boat lanes and beachheads clear of disabled craft so that movement to the beach is maintained.
1. True
 2. False

QUESTIONS 13-56 THROUGH 13-60 PERTAIN TO AIRCRAFT IDENTIFICATION.

- 13-56. The widest part of the fuselage is near the center. This is a characteristic of what type of aircraft?
1. Single-engine
 2. Twin-engine
 3. Multiengine
 4. Single-engine, propeller-driven

- 13-57. It is sometimes better to study an aircraft shadow rather than the aircraft itself.
1. True
 2. False

- 13-58. The use of the fuselage for aircraft recognition is primarily restricted to what items?
1. Color only
 2. Location only
 3. Color and location
 4. Size and shape

- 13-59. What is the primary recognition feature used in the identification of helicopters?
1. Rotor system and number of rotors
 2. Shape
 3. Size
 4. Tail boom

- 13-60. Exact names and the designations of aircraft are very important in determining the type of aircraft.
1. True
 2. False

QUESTIONS 13-61 THROUGH 13-64 PERTAIN TO SHIP IDENTIFICATION.

- 13-61. What is the first determination you should make in the identification of a ship?
1. Size
 2. Type
 3. Naval or merchant
 4. Ship course
- 13-62. Using the information "Length 300 to 400, displacement 1,500 to 4,000 tons, a helicopter pad astern," what ship is identified?
1. Destroyer
 2. Frigate
 3. Hydrofoil
 4. Cruiser
- 13-63. Which of the following features would be an aid in the identification of an auxiliary ship?
1. Heavy armament forward
 2. Cranes and booms on deck
 3. Aircraft on deck
 4. Open deck areas forward
- 13-64. What type of ship is the most elusive of all naval vessels?
1. A destroyer
 2. A hydrofoil
 3. A cruiser
 4. A submarine
- 13-65. What is the primary factor in determining the class of submarine?
1. Length
 2. Sail configuration
 3. Bow profile
 4. Hull profile
- 13-66. What sail placement coding should you give a submarine if the sail is centered slightly aft of the hull midpoint?
1. One
 2. Two
 3. Three
 4. Four
- 13-67. What bow profile coding should you give a submarine if the bow shows a rounded and raked appearance?
1. Five
 2. Six
 3. Seven
 4. Four
- 13-68. What type of submarine usually maintains constant patrol that places her long-range, surface-to-surface missiles within range of her intended target?
1. SS
 2. SSG
 3. SSGN
 4. SSBN
- 13-69. In appearance group three, the hull type "raised 1-3" is represented by what number?
1. 11
 2. 43
 3. 45
 4. 53
- 13-70. Usually, the raised portion of a hull is how many meters?
1. 1 to 2
 2. 2 to 3
 3. 3 to 4
 4. 4 to 5
- 13-71. In the sequence of uprights coding, the letter H has what meaning?
1. Funnel
 2. King post
 3. Hallen
 4. Gantry
- 13-72. In the coding of uprights, how should you code the letters KMCF?
1. King post, mast, crane, fan
 2. King post, main, crane, funnel
 3. King post, mast, crane, funnel
 4. King post, mast, crow's mast, funnel

13-73. When two cranes are mounted on the same pedestal, but are arranged fore and aft, they are coded as one crane.

1. True
2. False

13-74. What bow design should you give a merchant ship whose bow angles vary greatly?

1. Maier
2. Vertical
3. Straight plumb
4. Raking

13-75. What stern design should you give a merchant ship whose stern is butted and straight, rounding only at the bottom?

1. Spoon
2. Cruiser
3. Counter
4. Round

